

EA EAW[®]

EASTERN ACOUSTIC WORKS

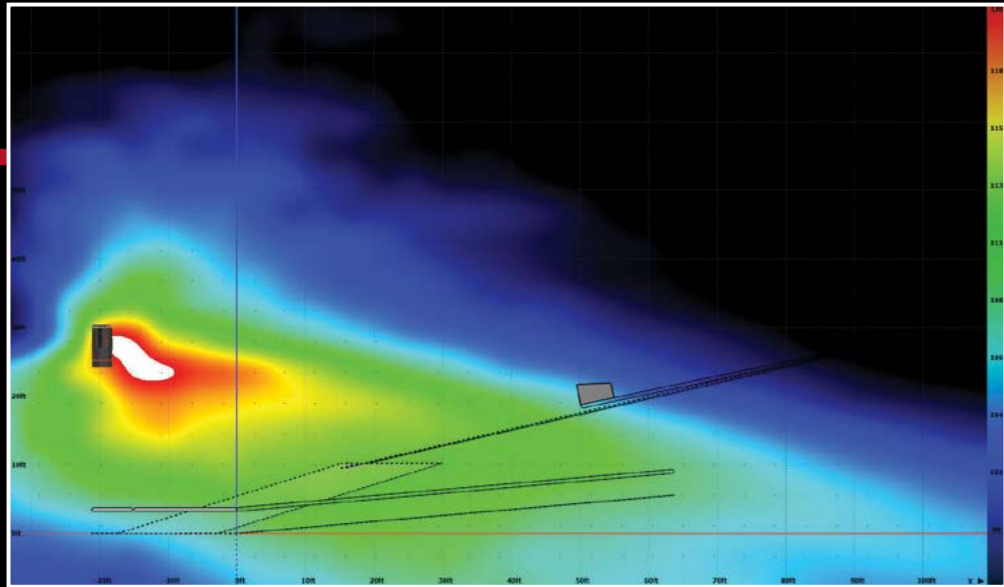

Resolution 2
HELP FILE

Table of Contents

Section 1 – Introduction	6
Section 2 - Menu Features.....	7
File Menu	7
Edit Menu	8
View Menu.....	8
Network Menu	9
Options Menu.....	10
Tools Menu.....	11
Window Menu.....	12
Help Menu	13
Section 3 - Getting Around Resolution	14
The Array View Window	14
The Venue View Window	16
The Project Explorer Window.....	20
Project Explorer Window Hierarchy	20
The Properties Window	24
Surfaces	25
Arrays.....	26
Copy/Paste/Link Processing	27
The Frequency Response Window	29
Section 4 - The Network Configuration View	32
Parameter Synchronization Status	34
Parameter Sync Window	35
Adaptive Systems Network	36
Configure Dante Network Interfaces.....	36

The Private Network.....	36
The DHCP Network.....	37
Dante Controller.....	38
Preset Manager.....	38
Going Online.....	39
Assigning Physical Arrays/Modules to Modeled Arrays/Modules.....	40
Assigning Mixed ADAPTive Arrays.....	42
Managing Arrays.....	43
Assigning Inputs.....	45
Selecting Analog or AES Input (ADAPTive Systems).....	47
Selecting the Net or Net Aux Input (ADAPTive Systems).....	47
Dry Contact Enable (AC6).....	48
Selecting Auto (NTX & Radius Systems).....	49
Selecting Analog (NTX & Radius Systems).....	50
Selecting Dante (NTX & Radius Systems).....	50
Adaptive Systems Diagnostics Window.....	50
The Overview Tab.....	51
The Meters Tab.....	51
The Maintenance Tab.....	52
The Temp Log Tab.....	52
The Impedance Log Tab.....	53
The Error Log Tab.....	54
The Acoustic Measurements Tab.....	55
System Health.....	56
Monitor Only Mode.....	58
Going Online with UXA Amplifiers.....	59
UXA4416 Input & Output Configuration.....	62

Loading Greyboxes for UXA4416.....	63
UXA4401/UXA4403/UXA4807 Network View Processor	71
UXA4401/UXA4403/UXA4807 Processor Dialog	72
UXA4401/UXA4403/UXA4807 Input Channels Tab	73
UXA4401/UXA4403/UXA4807 Zone Channels Tab	77
UXA4401/UXA4403/UXA4807 Output Tab	80
UXA4401/UXA4403/UXA4807 Settings Tab	82
UX48, UXA4406, UXA4410, UXA4810 Input Section	87
UX48, UXA4406, UXA4410, UXA4810 Output Section	88
Loading Greyboxes for UX48, UXA4406, UXA4410, UXA4810	89
Unify Processor Interfaces.....	92
Section 5 - Entering 3D Audience Areas	95
Modeling Basics	95
Editing Surfaces	96
Surfaces (Polar Data Entry Mode)	96
Options for Adding a New Surface	99
Adding A Balcony (Polar Data Entry Mode).....	100
Front of House Position	101
Adding a Stage (Polar Data Entry Mode)	102
Adding Sides (Polar Data Entry Mode)	103
Adding Corners (Polar Data Entry Mode).....	106
Entering Surfaces – Alternate Methods	108
Surfaces (Laser Data Entry Mode)	109
Adding Sides (Laser Data Entry Mode)	111
Adding Corners (Laser Data Entry Mode).....	111
Image Import	112

Saved Acoustic Models (SPL Map & Adaptive Settings).....	117
SPL Models	119
SPL Distribution Chart.....	121
Section 6 - Working With Arrays	124
Adding an Array - Launching the Array Assistant	124
Array Settings Page.....	125
Coverage Goals page	127
Modifying an Array via the Array Assistant	129
Differences between Traditional Line Arrays and Anya/Anna Arrays in the Assistant	129
Optimizing Radius Line Arrays in Resolution 2.9 and up	130
Cardioid Arrays with RSX18F & SBX118F Subwoofers.....	134
Working with Anya and Anna in the Model	138
Spatial EQ.....	139
Air Loss Compensation and Adaptive Arrays.....	141
Working with Otto in the Array Assistant	144
Working with Otto in the Properties Window	146
Working with Otto in the Array View Window.....	147
Going Online With Otto	148
Using Mixed Adaptive Arrays	150
Find Me (Trilateration)	152
Section 7 - Appendix.....	156
Anya/Anna Voicings.....	156
Exporting from Resolution into EASE	159
Upgrading Firmware on Adaptive Modules	164
Upgrading Firmware on NTX & Radius Modules.....	167
Upgrading Firmware on UX/UXA Devices	169
Contacting EAW.....	171

Operating Questions.....	171
General	171

Section 1 – Introduction

EAW Resolution™ 2 is a tool to assist sound system designers and engineers to select, configure, and implement EAW loudspeaker products. Resolution™ 2 predicts *direct* sound pressure level (SPL) in a ‘virtual’ venue. Signal processing can be applied in software, and the resulting frequency response calculated for ‘virtual microphones’ throughout the model. Additionally, Resolution™ 2 performs mechanical calculations for a given array or loudspeaker configuration to assist the user in correctly rigging their sound system.

Resolution Help Videos and Tutorials can be found on the [EAWVideo Youtube Channel](#) or on the [Resolution Youtube Playlist](#).

A Note about Compatibility with Resolution™ 1 Models

Though Resolution 1.x models are displayed in two dimensions, Resolution 2 will accept and open these files without issue. Users should expect the same acoustical results in both software versions, but may also gain additional insight into a Resolution 1 model viewed in Resolution 2 due to the enhanced three-dimensional viewing options available.

Due to the significantly more complex audience area data in Resolution 2, however, these files will not open successfully in Resolution 1. If users wish to maintain Resolution 1 compatibility for a given file, they should not save it in Resolution 2, or should maintain a separate copy of the original file.

System Requirements

EAW Resolution 2 requires an IBM®-compatible PC with Windows 7® or Windows 8® operating systems, including a standard Ethernet port to connect the computer to the network and control Adaptive loudspeaker modules. Though processor speed and memory size primarily impact only calculation time, the following specifications are recommended for useful operation:

	MINIMUM REQUIREMENTS	RECOMMENDED SPECIFICATIONS
Processor	2.2 GHz Dual Core Processor	2.8 GHz Quad Core Processor
Memory	2 GB RAM	8 GB RAM
Screen Resolution	1024 x 768 display resolution	1920 x 1080 display resolution
Operating System	Windows 10	Windows 10
Storage	1 GB available HD space	1 GB available HD space

NOTE: Support for Windows versions earlier than 10 (8, 7, XP, Vista) has been discontinued by Microsoft. As a result, Resolution is not supported for these operating systems. Use of parallel operating systems is not recommended or supported. A PC running Windows natively is required. 4K screen resolutions are not supported at this time.

Section 2 - Menu Features

File Menu

A Resolution File contains venue and loudspeaker information. The following options are available from the 'File' drop-down menu:

New - Creates a new Resolution File (clears all data in the current model).

Open - Opens a Resolution (.eawresolution format) File, or an EAW log file (.eawlog format)

Open Acoustic Model - Opens a saved acoustic model (*.eawcab file)

Save - Saves the current settings to currently open Resolution File.

Save As... - Saves the current settings to a Resolution File under a new name.

Save Acoustic Model - Opens dialog to save acoustic model with ADAPTive settings

Import - Used to place previously-saved .eawvenue or .eawarray files into the default Resolution file folders. Once imported, the files can be found using the "Load Preset" button for either venue or array.

Import Drawing – Opens the dialog window that allows for image import.

Export EASE File - Exports the current design as a file that is compatible with EASE software (for more detail about this, see our EASE Export Tech Note)

Create PDF - Outputs information for each loudspeaker array utilized in a Resolution file

Create CSV - Creates a spreadsheet (readable via Excel) with all pertinent data of the design.

Recent Files - Recall recently-used Resolution Files.

Exit - Quits the Resolution software.

Edit Menu

Undo - Undoes your last action.

Redo - Re-does your last “undone” action.

View Menu

Venue Configuration - Opens the “Venue Configuration” window, which displays the venue and array geometry in 2D and 3D views.

Network Configuration - Opens the “Network Configuration” window, which allows access to loudspeaker control and configuration parameters, both ‘virtual’ (offline) and online.

Toolbars

Main Toolbar Toggles the main toolbar on or off

File Toolbar Toggles the file toolbar on or off

Edit Toolbar Toggles the Edit toolbar on or off

Venue Views

Free View Changes the Venue View screen to 3D view that can be rotated with the mouse.

Side View Changes the Venue View to a defined X,Y location and rotational angle (the view is always vertical). This allows the view to be parallel to the aim line of an array, the center line of a surface, or arbitrary user defined position.

Top View Changes the Venue View screen to show X and Y axis view.

Front View Changes the Venue View screen to show Y and Z axis view.

Enable Calculations - Toggles venue calculations on and off

SPL - Toggles visibility of sound pressure levels.

SPL (mic only) - Toggles visibility of sound pressure levels for microphones only.

SPL Map - Toggles visibility of sound pressure levels in free space. Note: With SPL map disabled but SPL enabled, sound pressure levels will continue to be mapped to venue surfaces.

Array Names - Toggles visibility of array names.

Aiming Lines - Toggles visibility of green aiming lines, which extend from the central axis of each loudspeaker until intersecting a venue surface. Adaptive arrays (Anya, Anna, Otto) also display aiming lines. Aiming lines for Adaptive arrays are shown for each module, though sources within a module are dispersed with a higher resolution. Adaptive aiming lines are intended to give an approximate idea of how the array is allocated when determining its vertical coverage.

Aiming Coverage Lines - Toggles visibility of red coverage lines, which indicate 'soft edges' of system coverage (6dB down point).

Contour Lines - Toggles visibility of user selectable SPL dB down points (selected in Options menu)

Show Coverage Lines- Toggles visibility of dispersion pattern of speakers in the project.

Show Excluded Surfaces- Toggles visibility of any excluded surfaces in current project.

Show Sweep Lines – Displays a series of green lines showing which sections of each surfaces are being covered

Show Venue Detection – Displays a pink line representing how the venue is being calculated.

Network Menu

Connect - Poll network for all available devices.

Refresh Network - Refreshes network connection on all available devices

Disconnect - Discontinue network polling and disconnect from any connected network devices.

Configure Dante – Select which Network Interface Card (NIC) to use as the primary network interface.

Auto Identify - Enabling the **Auto Identify** button will trigger the white LED indicator on an Adaptive Module or modules in an array to turn on when selected in the **Online Devices** list or in the currently assigned Adaptive module in the **Venue** window. Selecting a single Adaptive Module will turn the LED on that one module, selecting an array will turn on all the LEDs in that array. This is especially helpful when assigning the physical arrays displayed in the **Online Devices** list to the arrays in the **Venue** model.

Preset Manager – Opens the Preset Manager dialog window

Upload Array Parameters - Clicking the **Upload Array Parameters** button will send all signal processing including Adaptive Performance processing and user signal processing to the appropriate Adaptive Modules. The status screen will indicate if this process completes

successfully. If an error occurs, exit the status screen and select **Upload Array** parameters again.

This button will be greyed out if adaptive performance calculations are incomplete. If calculations are complete but modules are not assigned, the button will remain clickable but will present an error, "Please make sure loudspeakers are connected to the network and assigned".

Unify Processor Interfaces – If connected to a processor via DANTE & Control (ethernet), this function communicates to Resolution this is the same device.

Options Menu

Temperature and Humidity - Set the Temperature and Humidity of your venue.

Changing these values will modify air absorption characteristics, and therefore resultant SPL on venue surfaces. These parameters are also used in calculating air loss compensation processing for products that support this feature.

Without Air Absorption - Toggle between an SPL calculation with and without air absorption based on the user defined temperature and humidity values.

Auto-Adjust SPL Range - Automatically determines the difference between highest and lowest SPL within a given file, and sets limits of SPL color scale to these values.

SPL Interpolation - Affects how quickly an SPL map is created. Available settings are:

Fastest SPL mapping is rendered in the shortest amount of time. To accomplish this, the resolution (detail) of audience area mapping is decreased.

Normal Standard SPL resolution is used. This offers the best balance of resolution and calculation speed.

Best SPL mapping is divided into multiple steps, beginning at low resolution and increasing as more time elapses. This provides the user with initial data in the shortest amount of time, but also provides higher-resolution information if given more time.

Side View Contour Lines - Defines side view contour line SPL increments. In the side view, contour lines are positive (increasing) increments starting with the highest SPL value on the venue surface. Selectable in 1, 2 and 3 dB increments.

Top View Contour Lines - Defines top view contour line SPL increments. IN the top view, contour lines are negative (decreasing) increments starting with the highest SPL value on the venue surface. Selectable in 1, 2 and 3 dB increments.

Design Factor - Selects the design factor as it relates to the working load limits of a design.

Resolution uses this selection to alert the user when stresses on loudspeaker rigging components have exceeded the selected design factor.

Note: ALWAYS READ AND ABIDE BY ALL RIGGING-RELATED WARNINGS AND INDICATIONS, INCLUDING USER MANUAL(S) AND PRODUCT-RELATED INSTRUCTIONS AND LABELS. FAILURE TO DO SO MAY RESULT IN INJURY OR DEATH.

SI Units - All measurements are shown using the metric system

US Units - All measurements are shown using the US system.

Max SPL - SPL is measured as a maximum output per passband of a loudspeaker. In practice this may result in an unusual tonal response since each passband is driven to its maximum output independently (i.e. if low-frequency components in a bi-amp system are capable of 6 dB more output than high-frequency components, the LF passband will display as 6 dB higher). Max SPL is used as the default setting as it correctly demonstrates the maximum output capabilities of the system.

Flat SPL - SPL is measured as the greatest output of a loudspeaker while maintaining a consistent broadband tonal response. Processing is included in this calculation, but Resolution does not permit equalization or gain to boost modeled output above a loudspeaker's actual output capabilities (i.e. a loudspeaker capable of 130 dB SPL at 1 meter cannot be 'turned up' to 135 dB SPL with a +5 dB gain adjustment).

ADAPTive Venue Detection Method – Toggles between adjusting vertical coverage to extend to the sides of a venue (Wide) or to keep coverage focused to surfaces directly in front of array (Narrow).

Color Theme – Set the Resolution color theme to Light or Dark, or follow the system setting. The default setting is "Windows Setting" which will match the theme specified in the user's Personalization color settings. Resolution must be restarted for a change in setting to take effect.

Tools Menu

Recalculate - Recalculates the SPL map on the defined audience plane.

SPL Distribution Chart – Opens window displaying SPL distribution throughout model

Set Global Ear Height – Changes the ear height of every surface in the model (floor, seated, standing).

Find Me (Trilateration) - Trilateration provides users with the ability to "map" a venue in 3D utilizing only two Anya arrays, a computer running both Resolution and Smaart, and a measurement microphone.

Inventory Manager - Defines which EAW products are included in available loudspeaker models under the Array Assistant. This is particularly useful for rental firms, as it allows the product list to be narrowed to match their inventory.

Under this window, users can also view the release notes for a product and access web-based data (requires an internet connection) via a hyperlink. Select from the list of Resolution-supported products available in your inventory. Unselected products will not appear in the property pane for use when building arrays.

Firmware Manager - When online, polls devices on the network for their firmware options and provides means to update firmware when necessary.

Automatically Check For Updates - When selected, Resolution automatically checks for updates every time the software is started. The computer must have internet access for updates to be downloaded. To ensure that Resolution is automatically kept as up-to-date as possible, it is recommended that users enable this setting.

Check for Updates - Regardless of status of “Automatically Check For Updates” option, Resolution will immediately check for updates when this is selected.

Keyboard Shortcuts - Allows user to confirm and/or modify keyboard shortcuts, or restore defaults.

Window Menu

Array View - Toggles visibility of “Array View” window, which displays physical configuration of array in section view.

Project Explorer - Toggles visibility of “Project Explorer” window, which catalogs all loudspeaker and venue elements within the file.

Properties - Toggles visibility of “Properties” window, which displays all available parameters for loudspeaker and venue objects, selected either in Project Explorer or directly in graphical Venue Configuration window.

SPL Models – Opens a dockable window with all saved SPL models

Undo/Redo Manager – Opens a list of modifications that have taken place since a project has been open. It’s possible to revert back to a point in time by simply double clicking on a change description.

Frequency Response - Opens a secondary window showing the direct SPL response of your system based on the virtual microphones placed within the model

Link Groups - Opens a window with all enabled link groups

Help Menu

Help - Displays this help file.

About Resolution- Displays the version of the software.

Section 3 - Getting Around Resolution

Resolution is segmented into four major sections or “panes”:

- Array View**
- Venue View**
- Project Explorer**
- Properties**

Note: The relative size of each pane can be easily adjusted by dragging the borders between panes.

The Array View Window

Pane Overview

The Array View is located on the left side of the main Resolution window. This section of the software displays a side view of the currently-selected array, and includes information about suspension points and stresses on each critical point within an array’s rigging.

At the bottom of this window, users can also find information about the array height, depth, vertical aim angle, and overall weight (including flybars). The information in this pane corresponds to the array selected from the tabs in the Property Pane.

This Pane also displays the Design Factor used for the Resolution file, displays the array on a dimensioned grid, and allows access to an Auto Design feature for quick generation of a basic array.

Arrays are displayed in profile (side view). If a specific array element is currently selected, it is highlighted in blue.

The gray and blue lined grid in the background is a reference for real-world distances in the venue. An array is displayed with X and Y axis origins at (0,0) defined by the pick point at the fly bar. Line arrays are built from 1 or more items selectable and manipulated from the Properties Pane.

Mechanical Loads

For each array element (flybars, adapter bars, or loudspeakers), mechanical loads are calculated for each connection point to determine if the configuration is safe for suspension. Acceptable loads (within the user-specified Design Factor) are highlighted in green. Loads which approach stress limits are highlighted in yellow. Loads which exceed stress limits are highlighted in red. The actual load (in pounds or kilograms, depending on which unit system is selected) can be viewed by hovering the mouse over it.

NOTE: It is the user's responsibility to ensure that rigging above the flybar (also referred to as "above the hook") is suitable for suspension of the stated loads.

Several other features of the Array View are called out in the image below.

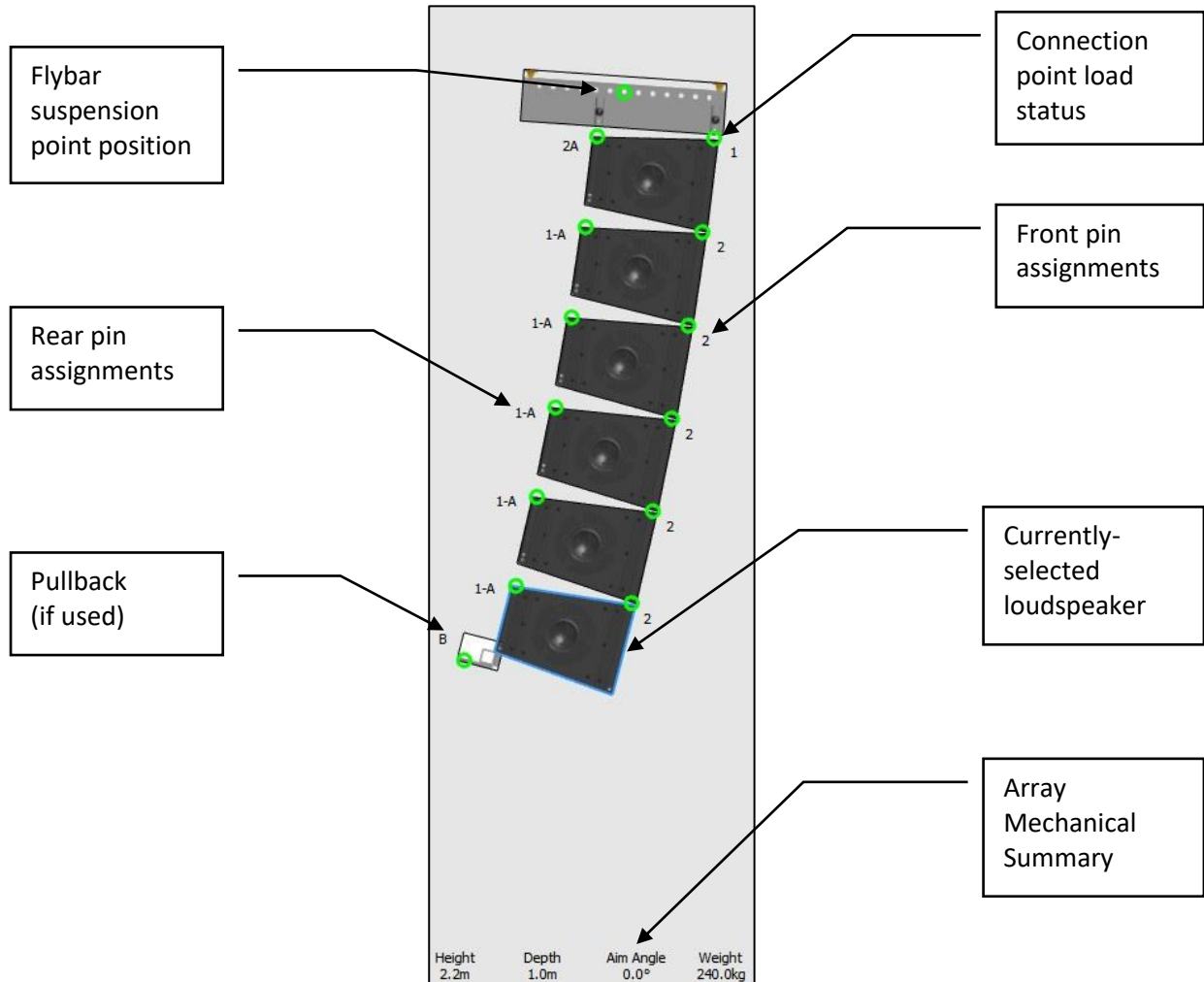

Note: For clarification on the labeling of pin assignments for your specific product, consult your product's Owner's Manua

The Venue View Window

The Venue View provides a visual representation of the loudspeaker arrays, venue geometry, and sound pressure level (SPL) mapping for a given system. Resolution can display this information in three different ways.

Top View

SPL is mapped onto each surface as viewed from directly above (“in plan”). In this mode, it is possible to zoom in or out, as well as scroll horizontally (in both the X- and Y-axis) by simply clicking and dragging. Take care not to click and drag an audience area or loudspeaker while navigating.

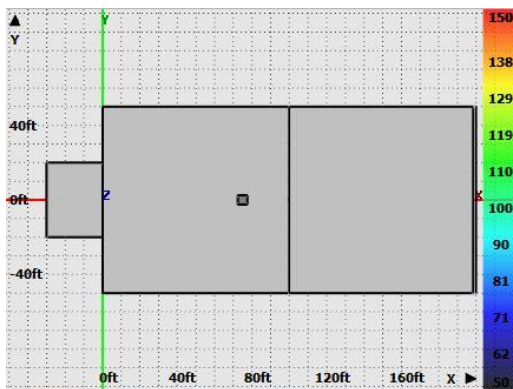

Side View

SPL is mapped onto a cross-sectional ‘slice’ through the venue, as seen from the side (“in section”). The location (y-coordinate) of the ‘slice’ is defined by a field in the top-right corner of the window. In this mode, it is possible to zoom in or out, as well as to scroll horizontally and vertically (in the X- and Z-axis, respectively) by simply clicking and dragging. While in this view, users can select which Y-axis “slice” to view by manipulating the “Y:” value in the upper right-hand corner. Surfaces currently intersecting the Y-axis “slice” will be displayed with a thick blue outline, while those that do not are displayed with a thin blue outline.

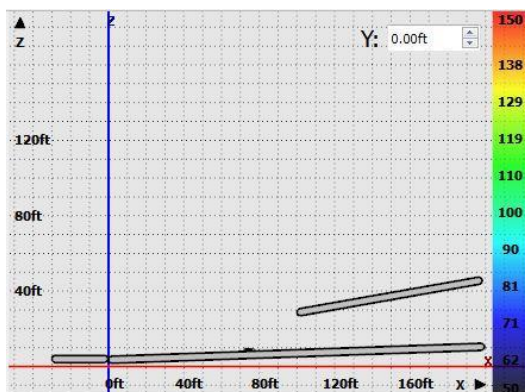

Slice View

SPL is mapped onto a cross-sectional slice through the venue, as seen from the side (“in section”). The location (X and Y coordinates) of the ‘slice’ defines where the view is offset. This position may be defined in the view controls in the upper right corner of the view. In addition, a rotational angle may be defined that rotates the view about the XY position. In this mode, it is possible to zoom in or out (using the mouse wheel), as well as to scroll horizontally and vertically by simply clicking and dragging.

While in this view, it is possible to change the XY position or angle of the view by entering values into the controls. The view can also be changed by selecting an array or surface to focus on. The selection button indicates what type of object the user may click on to change the view. Click this button to change to “Sel Array,” surface, both, or neither. When selecting an array, the view will be parallel to the array aim line. For surfaces, the view will be parallel to the center line through the surface. In all cases, selecting the Venue (in Project Explorer) will reset the view to default. Surfaces currently intersecting the Y-axis slice will be displayed with a thick blue outline, while those that don’t are displayed with a thin blue outline.

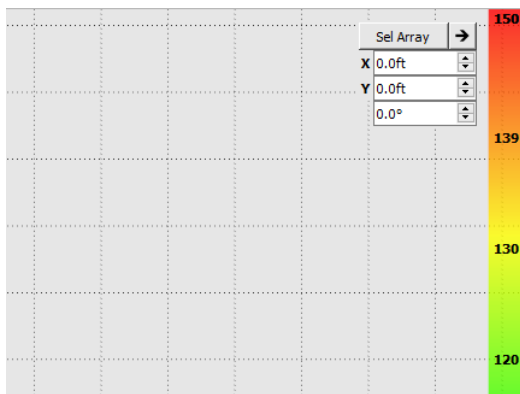

Front View

SPL is mapped onto a cross-sectional ‘slice’ through the venue, as seen from the front or back of the room. The location (x-coordinate) of the ‘slice’ is defined by a field in the top-right corner of the window. In this mode, it is possible to zoom in or out. While in this view, users can select which x-axis “slice” to view by manipulating the “X:” value in the upper right-hand corner. Surfaces currently intersecting the X-axis “slice” will be displayed with a thick blue outline, while those that do not are displayed with a thin blue outline.

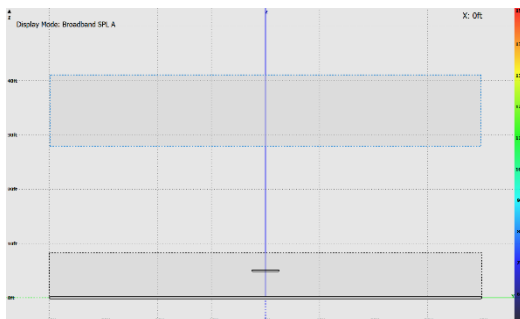

Free View

SPL is mapped onto each surface area, viewed in 3D. Users can manipulate the exact vantage point by using the mouse in combination with keyboard. In this mode, it is possible to zoom in or out, as well as to 'orbit' a center point in 3D by clicking and dragging. By holding the "Shift" key while clicking and dragging, this point can be shifted around the X-Y (horizontal) plane.

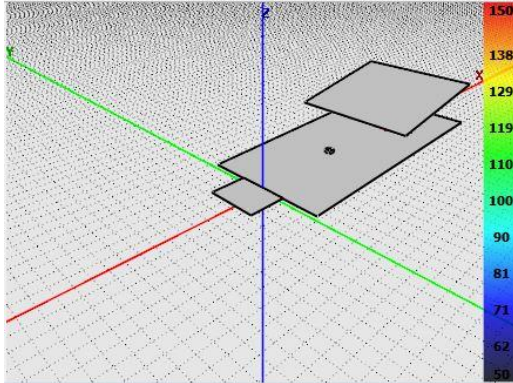

In all three views, the user can zoom in or out by using the toolbar buttons or the scroll wheel on the mouse (if the computer is so equipped). Additionally, the X, Y, and Z axes are color-coded (X is red, Y is green, Z blue) and labeled with text in all three views for easy identification.

SPL Scale

On the right side of all three view modes, the SPL scale is displayed. Values range from low (bottom, dark blue) to high (top, bright red). The limits of the scale and therefore the resolution (dB of change per color change) are variable, however. To automatically set the range of the scale to the range of SPL in the current prediction, the user may use the "Auto-Adjust SPL Range" function (under the "Options" menu, or by pressing "A" with default keyboard shortcuts). For manual control, single-click on the SPL scale.

Main Toolbar

A toolbar is also provided at the top of the window, allowing a number of Venue Window functions to be quickly accessed:

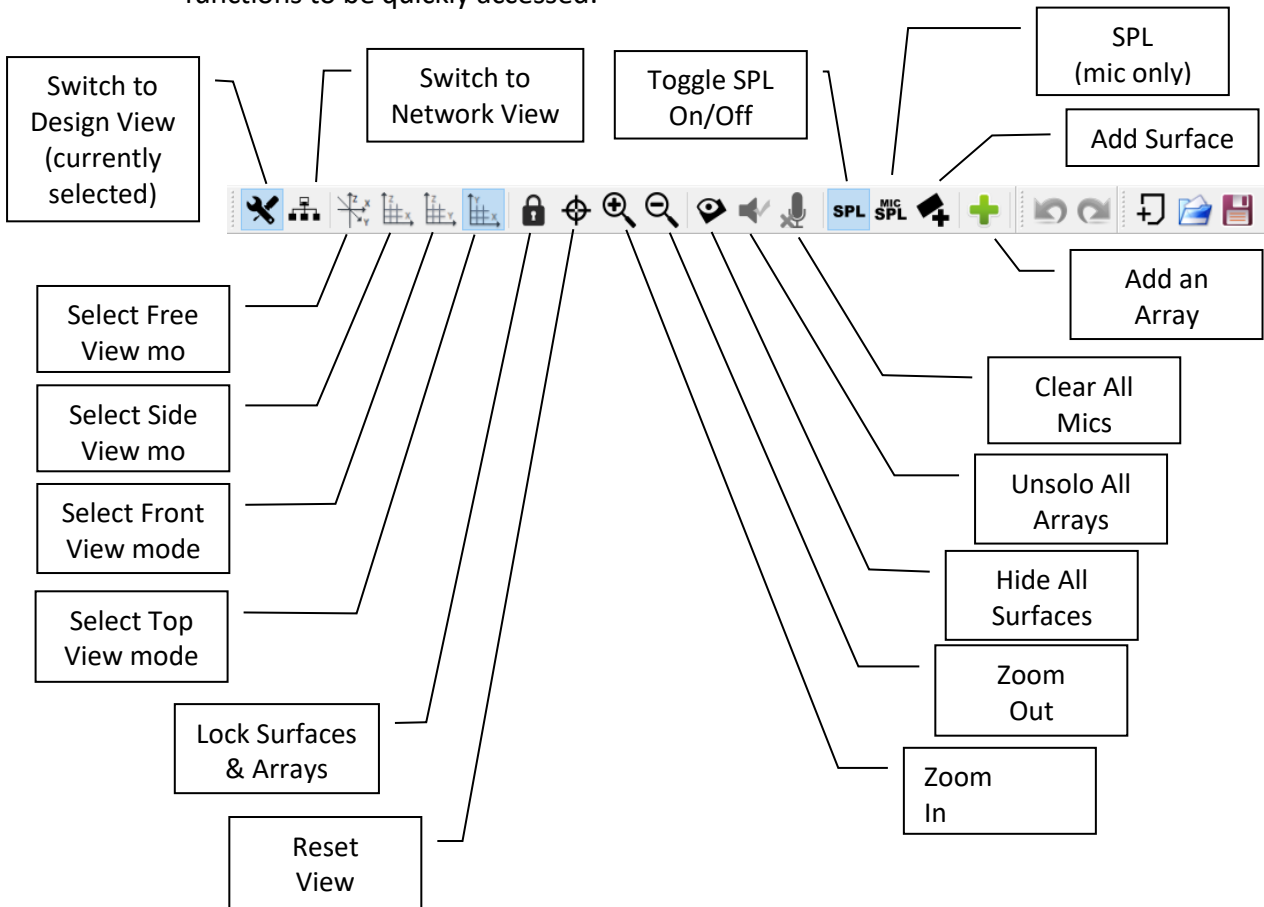

File and Edit Toolbar

Two optional toolbars are available allowing access to additional quick access functions:

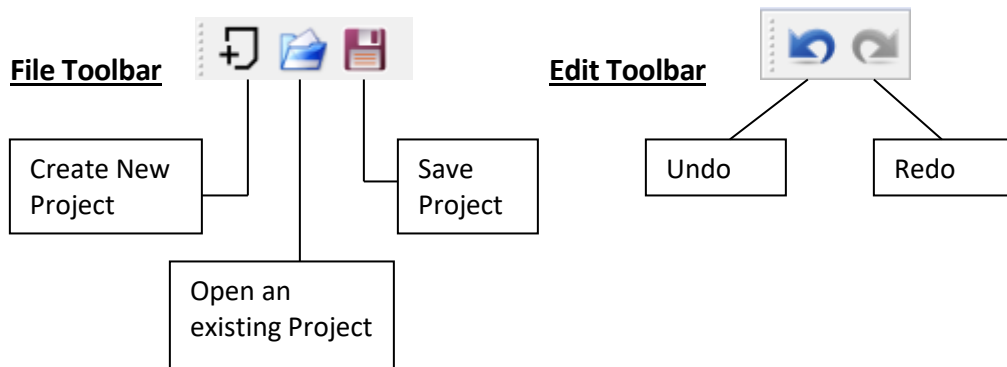

The Project Explorer Window

The Project Explorer Window provides a summary of all audience areas and EAW loudspeakers in the current model.

Project Explorer Window Hierarchy

This pane utilizes a tree organizational structure to allow the user to select which details are visible at any given time. The hierarchy of objects within 'Arrays' and 'Venue' are as follows:

Arrays

- Array 1 [Example: Line Array]

 - Array 1, Module 1

 - Array 1, Module 2

 - Array 1, Module 3

 - ...

- Array 2 [Example: Anya Array]

 - Column 1

 - Column 1, Module 1

 - Column 1, Module 2

 - Column 1, Module 3

 - ...

 - Column 2

 - Column 2, Module 1

 - Column 2, Module 2

 - Column 2, Module 3

 - ...

Notice that when users employ an Adaptive array, Resolution provides an additional sub-category of information, since each array can include multiple columns with each column containing a flybar and number of modules. Mechanically-articulated line arrays, on the other hand, only ever employ one column per array.

Project Explorer Window Buttons

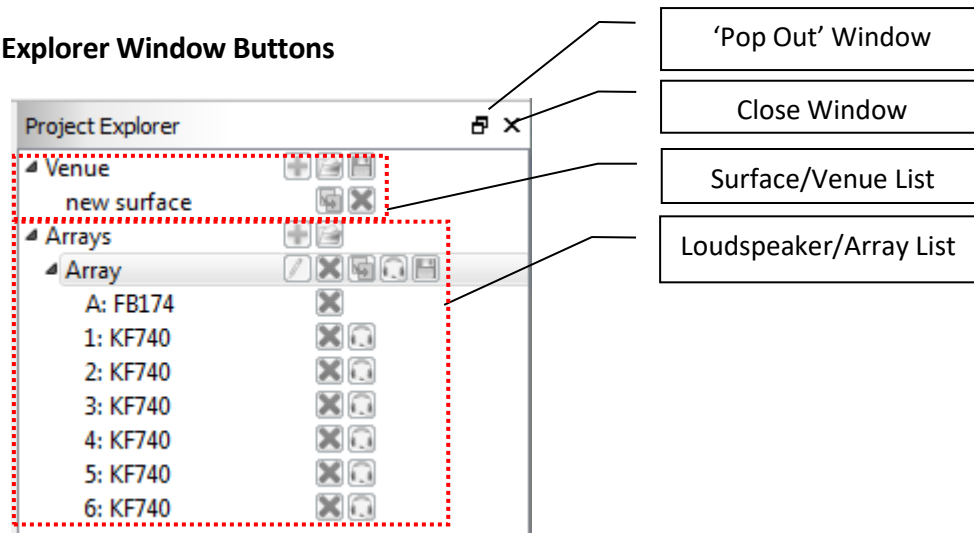

When the window is 'popped out', it can be placed anywhere on the screen. In addition to clicking on the button, users can also simply drag the window to a different location on the screen. The window can be 'popped in' or docked by dropping it into the ribbon on either side of the Venue window.

Venue

Magnified View of "Venue" Heading and

Sub-headings in Project Explorer Window

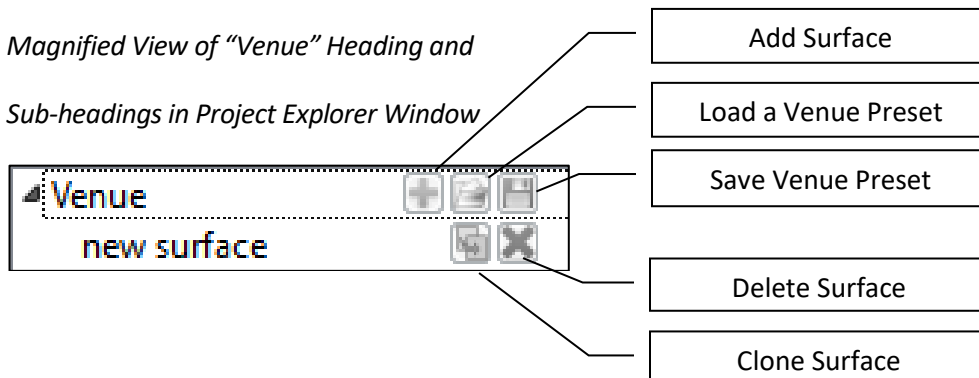

Add Surface - Allows the user to input a completely new surface to the model. New surfaces will be displayed in a "tree" format under the venue. When a new surface is added to the model, the following options are available for that new surface in the project explorer window.

- **Clone Surface** - This allows you to make a complete duplicate of any surface in the venue tree and helps to speed up the process of building complex venues and listening environments.
- **Remove Surface** - This allows the user to remove the currently selected surface. You will be prompted before final removal of the surface.

Load a Venue Preset - Allows the user to drop a preconfigured and saved venue preset into the model. Useful for when the venue remains the same but arrays will differ from show to show. Files are identified as .eawvenue extensions

Save Venue Preset - If the current model is a venue that the user will frequent, the room can be saved independently as a venue file in the software and recalled at any time. Venue files do not include any array data.

Arrays

Magnified View of "Arrays" Heading and Sub-headings in Project Explorer Window

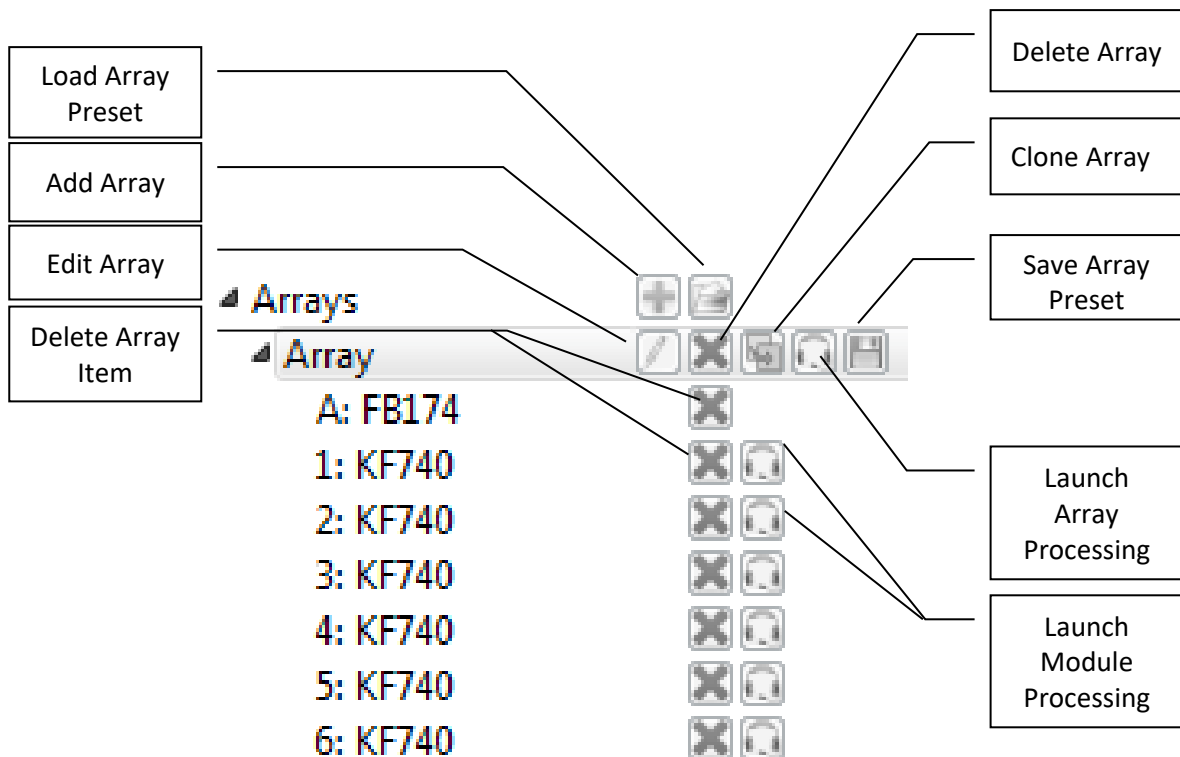

Upon initial start of the software, there will not be any arrays added to the model. In the project explorer window under **Arrays** the user can do one of the following:

Add array - Launches the array assistant.

Save an Array Preset - Stores the array as an array file.

Load an Array Preset - Loads a previously-saved array file. Stored arrays are useful when the system design is basically fixed but the venue will change from show to show.

Edit Array - Launches the array assistant as with **Add Array**, but already contains the current settings of the array.

Clone Arrays - Duplicate the current array and mirror or offset it.

Launch Processing - Opens the processing window for the current array or module (depending on which **Launch Processor** button is selected). Allows access to Greyboxes, rear switch settings, parametric equalization, delay, gain, and high-pass/low-pass parameters. If online with an Adaptive System, these functions are implemented in real time.

Delete Array/Item - Deletes the array, column or module/item (depending on which **Delete** button is selected).

Project Explorer Window Right-Click Functions

A number of functions are available by right-clicking in various locations within the Project Explorer window. When an array is selected, the following options are available:

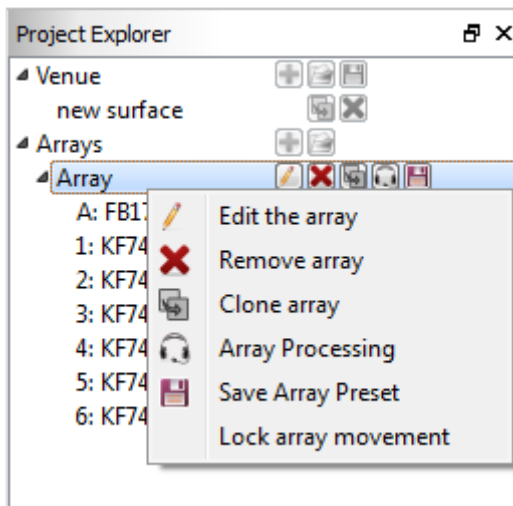

When a module is selected, the following options are available:

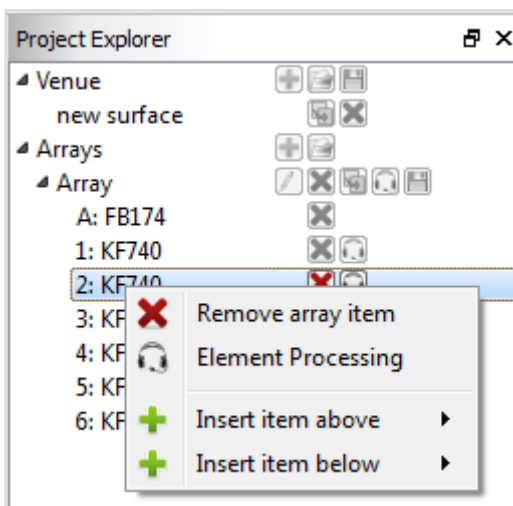

In almost all cases, these functions duplicate those provided by the icons directly to the

right of Project Explorer items. The exception to this is as follows:

Insert item above/below - Adds an item above or below the currently-selected array item. This may be a flybar, adapter bar, subwoofer, or line array module depending on the type of item currently selected.

The Properties Window

The Properties area is divided into two columns. On the left is the **property** and on the right is the **value**. The property column is fixed and cannot be altered. The value area is where adjustments are made and access to the value is achieved by clicking in the associated box on the right.

Front of House (FOH)

- a. Select on which surface FOH will be placed.
- b. X - Select the distance along the X-axis where the FOH location will be placed.
- c. Y - Select the distance along the Y-axis where the FOH location will be placed.

Temperature and Humidity

This area allows the user to define the current temperature and state of humidity within the venue. This is extremely important when taking advantage of the air-loss compensation feature available in EAW, DSP driven products.

Temperature - Enter the current temperature within the venue. This value can be updated at any time.

Humidity - Enter the current humidity within the venue. This value can be updated at any time.

SPL Options

The user has the option to let the software automatically adjust the SPL range for selected loudspeakers in the design or else manually set the upper and lower extremities of the measurement. The user can also select specific frequencies to map in the model.

Min SPL - Select the minimum amount of SPL that will be displayed in the SPL map

Max SPL - Select the maximum amount of SPL that will be displayed in the SPL map.

Display Mode - Select the range of frequencies that will be plotted within the SPL map.

Frequency - If 1/3 octave, 1 octave, or 3 octave range is selected, the user must select an appropriate frequency to be mapped.

Surfaces

Once surfaces have been added to the venue, the actual dimensions and conditions of the surface will be adjusted in the properties pane. Clicking in the value column on the right side of the window will allow editing of the surface parameters.

Name - Naming your surfaces is highly recommended as it is easy to lose track of the running order of surfaces in complex designs. Click on the current name of the surface to edit.

Start - Each surface must have an origin to determine where it will lay in the model. The origin of the surface can be anywhere you like. The (X,Y,Z) coordinate for each surface is defined as the front, center point. All movement and rotation is relative to this point.

X - Where along the X-axis the surface is centered.

Y - Where along the Y-axis the surface is centered.

Z - Where along the Z-axis the surface is centered.

Length - The length of the surface from the defined origin.

Width - The width of the front edge of the surface.

Width Rear - The width of the rear edge of the surface. Trapezoidal surfaces can be created by entering different values for 'width' and 'rear width'.

Inclination Angle - If the surface has a rake such as can be found in a theatre or balcony, enter the inclination here.

Rotation Angle - If there is a rotation required for the surface (such as in large arena designs), enter the rotation angle here.

Audience Area – Surfaces are considered audience areas by default. Unchecking this box means that Adaptive arrays (Anyra, Anna, Otto) will not consider these surfaces when their Adaptive processing is determining its vertical coverage pattern.

It's important to note that other settings can direct Adaptive coverage to or away from a surface regardless of whether or the surface is designated as an audience area. The start/end points selected for an Adaptive array's coverage, 'z' bounds selection, and the 'Extend Coverage' feature can also affect whether or not a surface is included in Adaptive coverage.

Ear Height - The vertical offset from the defined surface to the audience ear height. This surface is used for acoustic model calculation (i.e. as the target coverage area for the Array Wizard), the insertion height for virtual microphones, and the mapping surface for SPL. This can be defined for each surface independently, and chosen from four possible options:

Floor - The audience ear height is the same as the 'z' value of the surface.

Seated - The audience ear height is defined as 3.5 feet (approx. 1 meter) above the surface.

Standing - The audience ear height is defined as 5 feet (1.5 meters) above the floor surface.

Custom - Any custom value can be entered into the field.

Hidden - Checking the "hidden" box will make the surface opaque and remove it from the SPL calculations. *The surface will still be included in Array Wizard calculations -- if you wish to remove it from these calculations, delete it from the model.*

Locked - Surfaces cannot be accidentally moved or altered in the model. Once you have completed a surface, it is recommended that you lock it to prevent accidental changes.

Comments - Comments may be added for each surface. These comments will be saved in the eawresolution file.

Arrays

Once an array has been added to the venue, the physical parameters of the array can be adjusted. Clicking in the value column on the right side of the window will allow editing of the array parameters. Different parameters are available for different products, and the some parameters listed below may not be available for a particular product.

Adaptive Arrays include other unique features that are covered further below in the Help File.

Name - Naming your array is recommended as it is easy to lose track of the running order of arrays in complex designs. Click on the current name of the array to edit.

Speakers – The number of cabinets in the array (always '1' for point source).

Location – Each array must have an origin to determine where it will be positioned in the model. The origin of the array can be anywhere you like within the bounds of the chosen 'Max Hang/Min Trim' values. The (X,Y,Z) coordinate for each line array is defined as the pick point on the flybar for arrays. For point sources, the (X,Y,Z) coordinate is defined as the physical center of the cabinet. All movement and rotation is relative to this point.

X - Where along the X-axis the array is centered.

Y - Where along the Y-axis the array is centered.

Z - Where along the Z-axis the array is centered.

Bottom Height – The height of the lowest point of the array (adjusting this also adjusts the top height).

Max Hang – Limits the maximum height of the array. The physical dimensions of each cabinet are taken into account to prevent the array from exceeding this value.

Min Trim – Limits the minimum height of the array. The physical dimensions of each cabinet are taken into account to prevent the array from hanging below this value.

Height – Dimension of the array from lowest to highest point.

Depth – Dimension of the array from front to rear.

Weight – Total weight of the array.

Hang Style – Determines how the array will be flown, or if it will be ground-stacked (if possible).

Position – Determines which flybar hole is used as the pick point.

Tilt – Determines the vertical tilt of the array.

Aim – Determines the horizontal aim of the array.

Roll – Determines the rotation of the cabinet.

Use Pullback – Determines if a pullback bar is used, and its vertical tilt angle.

Coverage – Displays where coverage is desired. This is defined in the Array Assistant for mechanically articulated line arrays, and does not apply to point source products. Changing these values in the 'Properties' menu will only affect coverage for Adaptive products.

Extend Front/Rear Coverage – Allows user control over how much variation to accept at the edges of coverage.

Solo – Mutes all other arrays, unless they have been solo'd as well.

Chain Span – Displays the length of chain span if a pullback bar is used.

Locked – Locks the array from editing.

Copy/Paste/Link Processing

An array's processing parameters can be copied to another array using Resolution's copy/paste feature. Select the array you want to copy in the **Project Explorer** window, right-click on the EQ plot of the array in the **Properties** window, and select 'copy'. Select the array you would like to copy the parameters to in the **Project Explorer** window, right-click on its EQ plot in the **Properties** window, and select 'paste'.

An array's processing can also be linked to one or more other arrays. This will transfer any changes made to a single array's processing to the other arrays it is linked to in real time.

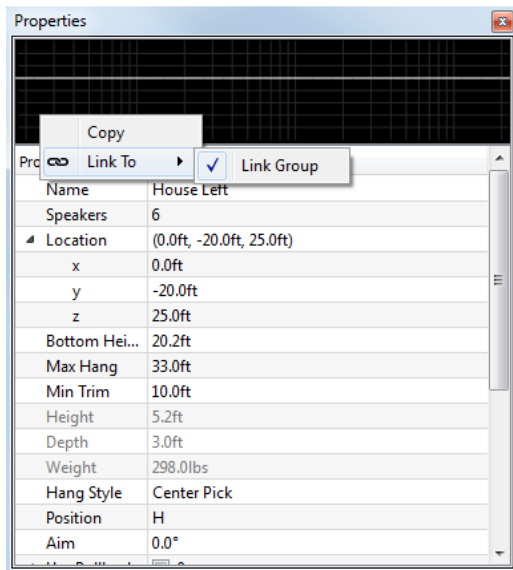

Once links are established, the Link Group pane can be used to view connections between arrays. The Link Group pane is accessed from the "Window" drop-down menu.

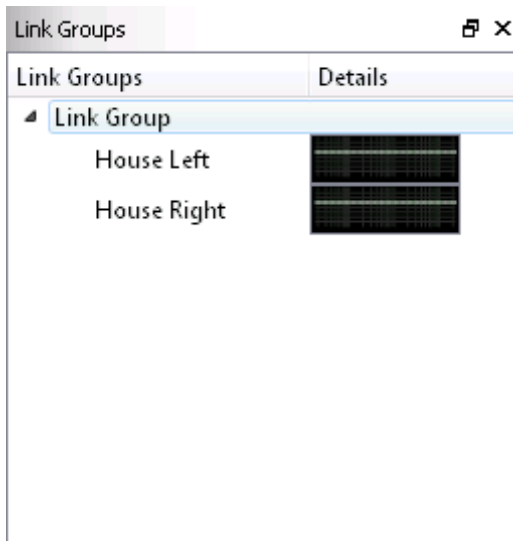

Right-clicking on items in the link group allows the user to un-link them, or to copy the parameters of the group to other items or groups. Clicking on an EQ window adjacent to the array name will open the EQ window for that array (which is linked to all other EQ windows within the group).

Parameters that are linked in Link Groups include: Parametric EQ, Gain, Mute, Polarity, HPF, LPF, Delay. Parameters that are **NOT** linked in Link Groups include: Voicing, Columns driven Adaptively/Uniformly (Adaptive products only).

The Frequency Response Window

Resolution offers the capability of displaying the calculated frequency response at one or more locations in a venue - called 'virtual microphones' - representing the direct sound (without the effect of room acoustics) at that location. Additionally, it is possible to store these measurements, modify the model, and then compare to new measurements. Accessed from the Window menu, or from the shortcut key "f", the window appears as follows:

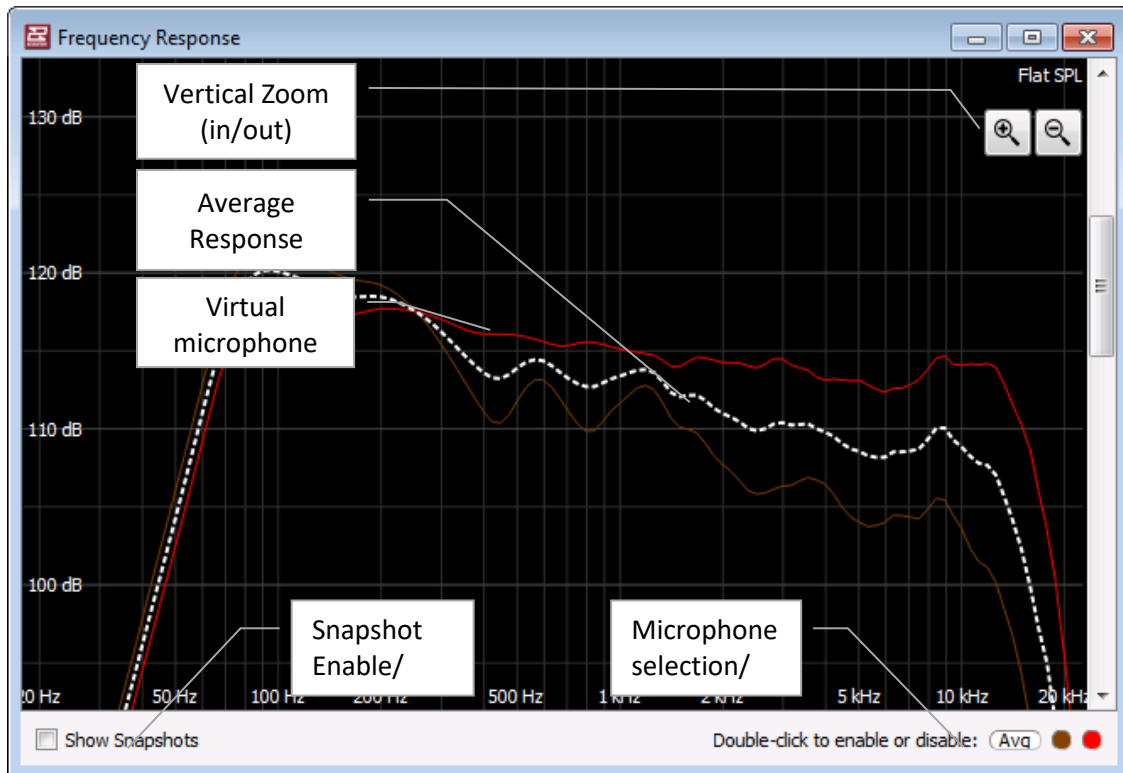

The average response is always displayed in white, and each virtual microphone response is displayed in the color with which the microphone is highlighted in the Venue view. Single-clicking a microphone color in the lower right-hand corner highlights that measurement. Double-clicking toggles the visibility of that measurement. Note that the average response is calculated from all virtual microphones in the model, regardless of whether they are visible or not.

Note that in addition to the +/- zoom buttons, the mouse scroll wheel also functions to adjust vertical zoom. Clicking and dragging within the frequency response window also slides the vertical scale up and down.

When "Show Snapshots" is selected, an additional pane is displayed:

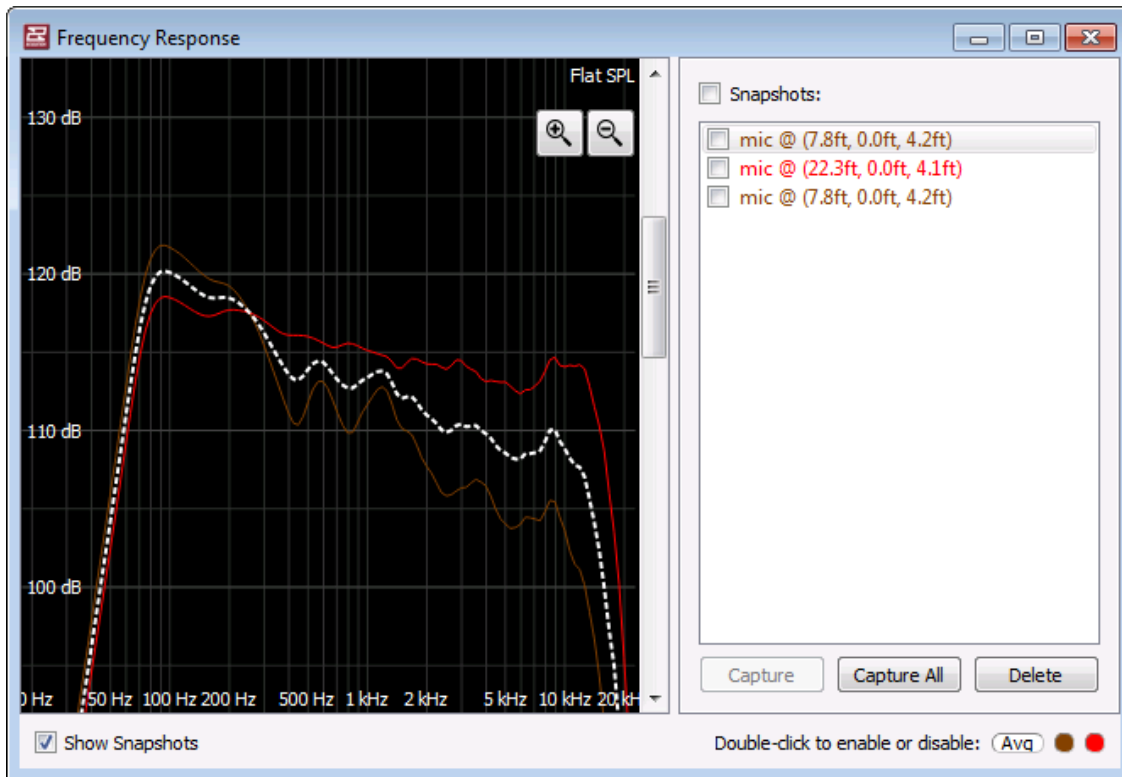

This pane adds the ability to store each microphone, give it a label and toggle visibility.

To store a snapshot, single-click the lower right-hand corner microphone you wish to store, and then click **Capture**. Alternately, simply click **Capture All** to store all virtual microphones. The default label for each will then be “mic @”, followed by the (X,Y,Z) coordinate of the virtual microphone. Note that the average response cannot be stored as a snapshot.

To delete a virtual microphone snapshot, select that snapshot from the **Snapshots** list and click **Delete**. Note that users can delete more than one snapshot at a time by shift-selecting (to select the range of snapshots between the first and last snapshot clicked) or control-selecting (to select only the snapshots that were clicked), followed by the “Delete” button.

To export a CSV file containing the frequency response data, right click on the Frequency Response window and select **Export to CSV**. This will copy all frequency response data into a .CSV file which can be saved for analysis in third party programs such as excel.

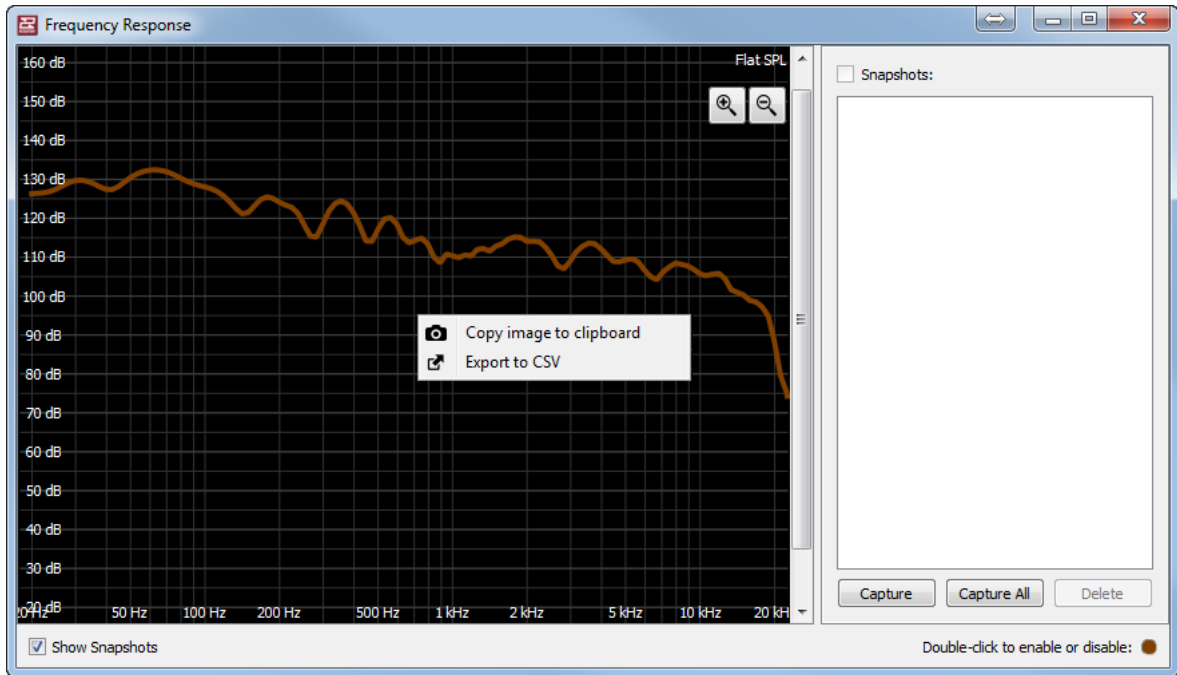

Section 4 - The Network Configuration View

The Network Configuration window provides control and monitoring of all Adaptive loudspeakers in the currently loaded Venue. All other loudspeakers (self-powered and passive) will be represented, but the current version of Resolution only supports control and monitoring of Adaptive products.

This mode can also display the **Array View**, **Project Explorer** and **Properties** windows in addition to the list of **Online Devices** and the Arrays and Loudspeakers area.

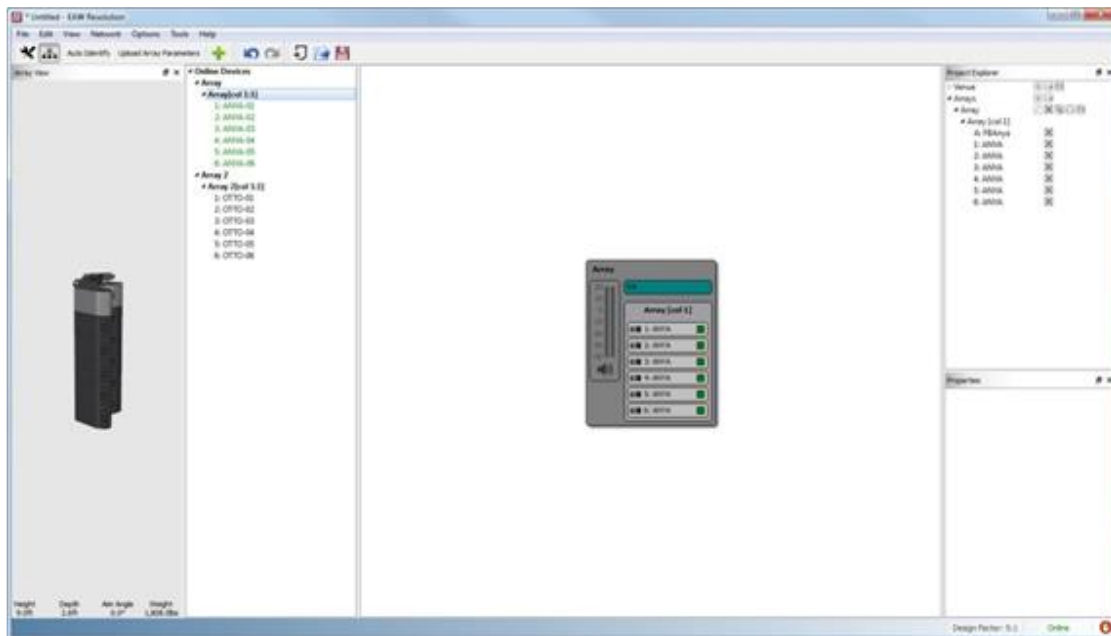

To switch to the **Network Configuration View**, either select **View>Network Configuration** from the **Menu** bar or click the **Network Configuration** view button on the **Tool Bar**.

This will change the **Tool Bar** to display the **Design View** and **Network Configuration View** buttons along with buttons for **Auto Identify**, **Upload Array Parameters** and **Add Array**.

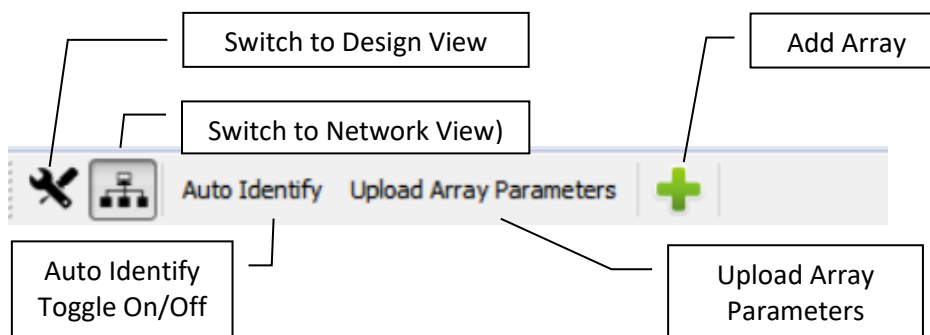

Auto Identify

Enabling the **Auto Identify** button will trigger the white LED indicator on an Adaptive

Module or modules in an array to turn on when selected in the **Online Devices** list or in the currently assigned Adaptive module in the **Venue** window. Selecting a single Adaptive Module will turn the LED on that one module, selecting an array will turn on all the LEDs in that array. This is especially helpful when assigning the physical arrays displayed in the **Online Devices** list to the arrays in the **Venue** model.

Upload Array Parameters

Clicking the **Upload Array Parameters** button will send all signal processing including Adaptive Performance processing and user signal processing to the appropriate Adaptive Modules. The set of modules receiving updated parameters will be limited to those contained in the arrays in the current SPL Model. If an array is not included in the currently selected SPL Model then its modules will not be updated. Refer to the SPL Models window for the set of arrays affected by an upload.

The status screen will indicate if this process completes successfully. If an error occurs, exit the status screen and select **Upload Array** parameters again.

Add Array

Clicking the Add Array button allows you to add more arrays to your design and works as described in the **Design View** section.

Parameter Synchronization Status

The bottom right hand corner of the Network Configuration View offers the user real-time feedback on the status of Adaptive System parameters.

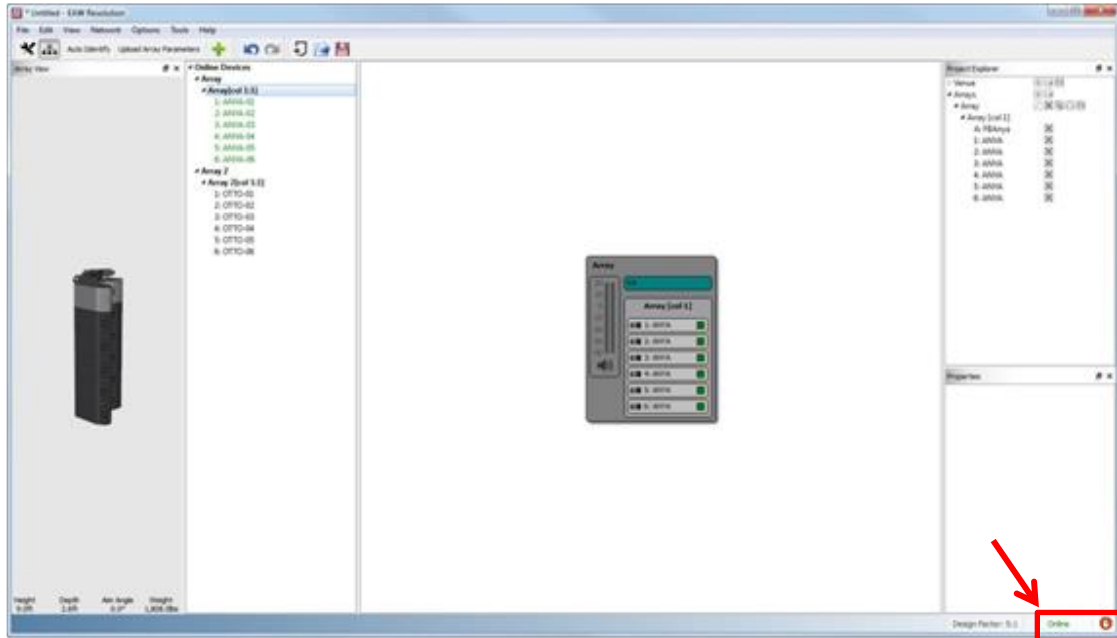

Resolution maintains constants two way communication with Adaptive products to and will alert the user should the Resolution model not match the parameters uploaded to the Adaptive system. The two status indications are as follows:

Parameters Out of Sync

When parameters in Resolution and the online Adaptive System are **out of sync**, Resolution will display a stop sign with a hand, indicating there is a difference between Resolution and the Adaptive system. When this icon is visible, the user should verify what has changed in the system, and re-upload parameters to the system if needed.

Online



Parameters In Sync

When parameters in Resolution and the online Adaptive System are **in sync**, Resolution will display two green circular arrows, indicating all parameters are properly synced and no action is required.

Online



Parameter Sync Window

Clicking in the parameter sync status symbol will bring up the 'Parameter Sync' window, which will contain additional details about the online devices.

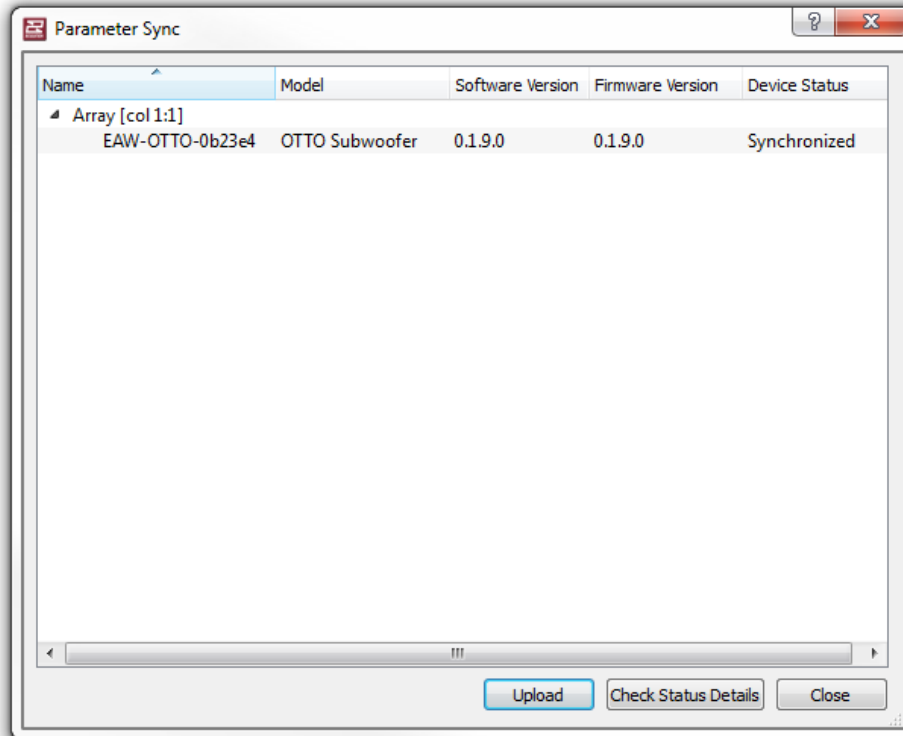

Check Status Details

Selecting the 'Check Status Details' button will manually poll the online Adaptive modules to check their status against the Resolution model.

Upload

Users can also upload parameters to the system using the '**Upload**' button found in this window. This mirrors the functionality of the 'Upload Array Parameters' button found in the top toolbar on the network view screen.

Adaptive Systems Network

There are two typical Network scenarios depending on how you set up your Network IP addresses:

- A default Private Network (using automatic private IP addressing)
- A DHCP Network (using an additional network switch with internal DHCP server)

**Refer to Audinate and Netgear documentation for additional information on implementation of Ethernet and their products.*

Support for the Netgear® Prosafe® 16-Port Network Data Switches [GS716T-200] can be found at: <http://support.netgear.com/search/GS716T-200>

Support for the Dante digital audio network can be found at: <http://www.audinate.com>

Configure Dante Network Interfaces

Primary and secondary Dante network interfaces can be configured by selecting **Configure** from the “Network” drop-down menu. This function allows Resolution to utilize the Dante network’s built-in backup capabilities. To see a Secondary Network Interface, a second hardware interface must be installed in the computer.

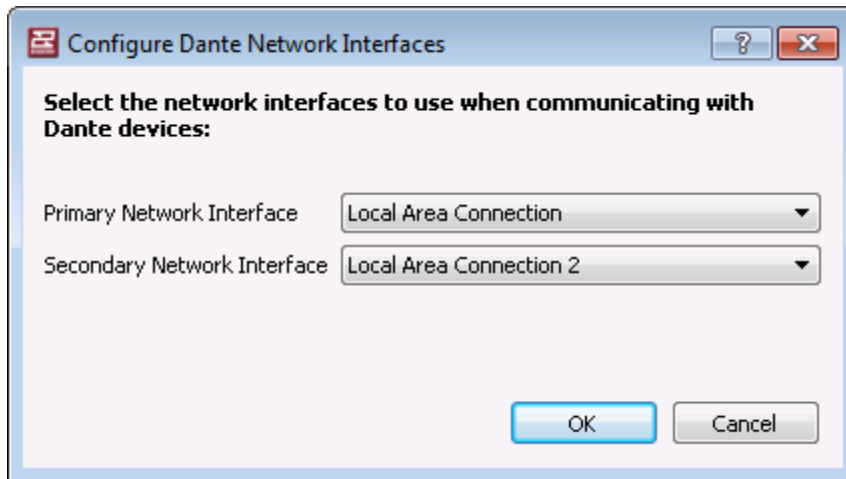

The Private Network

Each Adaptive System includes some number of Netgear switches depending on the number of modules included in the system. These switches do not include a DHCP server.

Each Anya module includes an Audinate Dante Network Interface Card (NIC). If the module does not detect a DHCP server on the network, then all modules will default to the Private Network range of IP addresses and each module will select a unique IP address from the following ranges:

- Primary Network (in redundant networks) and non-redundant networks
 - IP Address Range: 169.254.###.###
 - Subnet Mask: 255.255.0.0

- Secondary Network (in redundant networks only)
 - IP Address Range 172.31.###.###
 - Subnet Mask: 255.255.0.0

The computer running Resolution 2 connected to the network can automatically select an IP address in the primary network range if no DHCP server is detected on the network, but it generally is a best practice to manually assign your computer IP address and Subnet Mask in the Private Network range to speed up the discovery process. A computer on the Secondary network must be manually assigned an IP address in the range 172.31.###.###.

**Note: All Adaptive modules and the control computer must be connected to the same network!*

- *All Primary Ethernet ports on every Adaptive module must be connected to the same Primary network on the switches and Secondary ports to Secondary network on the switches.*
- *All switches must be linked Primary to Primary, Secondary to Secondary.*
- *Any Dante source device such as mixing consoles must also be connected to the same Primary and Secondary networks.*

The DHCP Network

You may find it useful to add a network switch to your FOH position (*two switches or a switch with redundancy for redundant networks*) to connect your Dante enabled mixing console or outboard Dante on-ramp and your control and monitoring computer running Resolution 2. This can be particularly useful if it has an 802.11n wireless router allowing you to use a remote desktop app on a tablet or another notebook computer to make system adjustments from anywhere in the venue.

**Note: The Dante protocol does not permit wireless adapters to be used for control or audio streaming.*

**Note: Careful consideration should be given to leaving your system connected to any Wi-Fi enabled network. EAW recommends disabling any wireless access during a show to prevent any unauthorized access to your system. You should enable extremely robust security measures as a minimum.*

Be sure any network switch you connect meets all of the minimum requirements required for a Dante network. EAW strongly recommends a Gigabit switch as a minimum. Gigabit switches are required if audio is sent over the Dante network. When redundancy is used, all locations in the network require redundant connection, so two switches (with DHCP)

must be used.

When Anya detects the DHCP server, then all modules will receive their IP addresses from the server. You can also set your computer's networking settings to "Obtain IP Address automatically" in Windows, further simplifying the network setup process.

Dante Controller

EAW recommends installing the Dante Controller application on your computer to give you better visibility and control over the entire Dante network. This is especially true when other non-EAW Dante devices (such as a mixing console with Dante network connections) are connected to your network.

Preset Manager

The Preset Manager allows the user to store and recall different states of an Adaptive system without opening new models or modifying the model in use. A preset includes the entire state of the array including coverage, EQ, mute state, gain, and voicing. Presets are stored locally on the user's PC, not the Adaptive modules themselves, so the PC is required to recall different presets.

To access the Preset Manager the PC must be connected to the network. The Manager is then opened by selecting it from the 'Network' Menu. The user can store/recall up to 10 different presets.

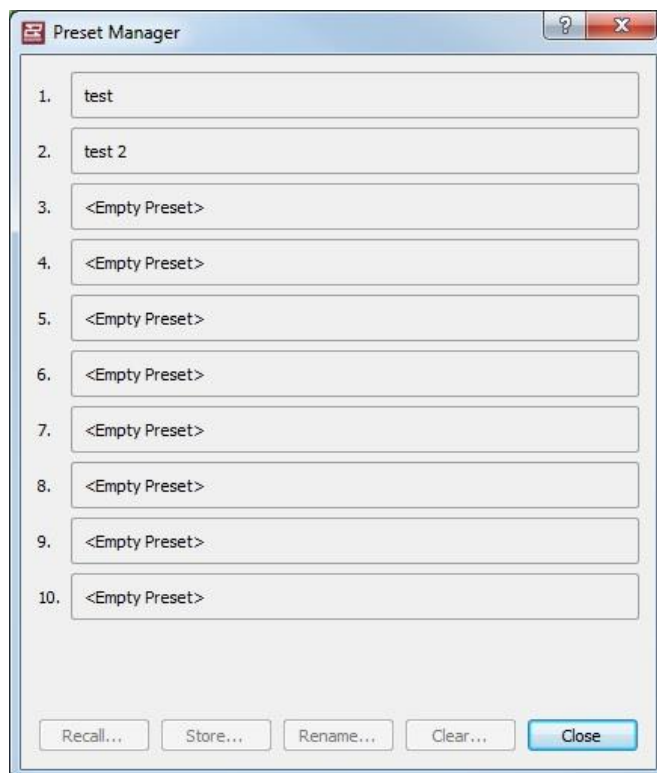

Recall – To recall a preset and upload it to the system, click the desired preset to highlight it, then press the ‘Recall’ button. This will open a window prompting the user which array(s) to upload the preset to. Once the arrays have been selected the preset will be uploaded, and after a few seconds a green icon will appear in the preset slot to indicate that the preset settings are in sync with the online system.

When a preset is uploaded Resolution will check the current online array configuration against the array configuration when the preset was stored. To perform correctly the online system must be in the same physical configuration as it was when the preset was stored. The user will be alerted if the configurations are not in sync.

Store – To store the current state of an Adaptive system as a preset, highlight one of the preset slots, and select ‘Store’. This will open a window prompting the user to give the preset a name. Enter the desired name of the preset and select ‘OK’ to store the current system state as a preset.

Rename – Highlight the preset you wish to rename, then select ‘Rename’. This will open a window prompting you to enter the desired name of the preset.

Clear – Highlight the preset you wish to delete, and select ‘Clear’. This will delete the preset and clear that slot to be used for another preset.

You can view our tutorial video of the Preset Manager [here](#).

Going Online

Before going online, be sure your computer is connected to the same Ethernet network as the networked loudspeaker system. Communications is established by clicking **Network** on the Menu bar and selecting **Connect**. Resolution 2 will then search for any Adaptive devices on the network and displays them in the **Online Devices** list. This list will include your computer running Resolution 2.

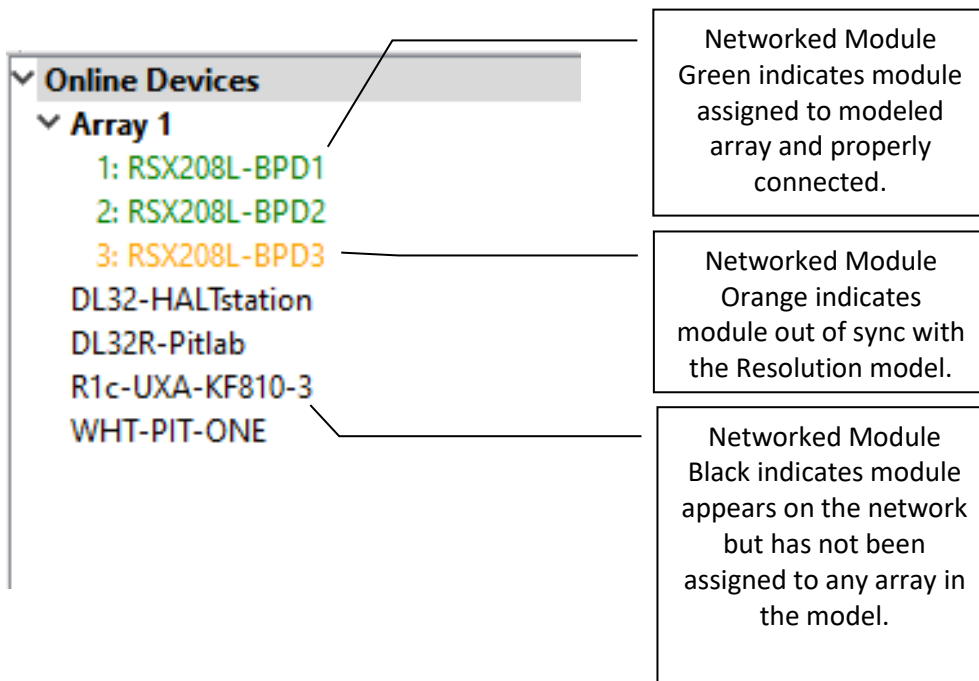

Adaptive, NTX or Radius devices are grouped according to how they are physically arrayed, so if you have assembled an array of two modules in a single vertical column for example, those will be listed as:

```

Array #
Column 1
EAW-Module-#####
EAW- Module -#####
.....
Column 2
EAW- Module -#####
EAW- Module -#####
.....
..and so on.

```

If an array does not automatically group; right click **Online Devices** select **Refresh Neighbor List**

The names of the individual modules in that Column will be listed in the order they are physically arranged. Stand-alone modules will be listed individually.

Assigning Physical Arrays/Modules to Modeled Arrays/Modules

***EAW's recommended best practice for Adaptive and Radius systems is to create your venue in the **Design View** and determine the optimum arrays needed to provide the coverage you will need prior to assembling, flying, energizing and connecting to the system. This will ensure you know how the Arrays will need to be configured.*

However, this is not required, and you can simply fly the arrays and connect Resolution 2 to your system with a blank Venue loaded if needed. **Note that the Adaptive Performance processing for Adaptive Systems will be calculated for any venue surfaces (or areas of coverage) in the model.**

It is best to at least enter a simple representation of the area you intend the System to cover. Adding arrays in the appropriate positions prior to going online will speed connection time allowing you to upload settings as soon as you associate a modeled Array with its physical Array.

If you have not defined any Arrays in your Venue, then you can simply click on each Array in the **Online Devices** list and drag them over to the **Network Configuration** desktop. This will open the **Array Assistant** dialog. Once you enter the settings and click finish, Resolution 2 will create an icon with the name of the Array, the list of arrayed modules in each Column in the Array, an Array Mute button, Input Level and Gain Reduction meters.

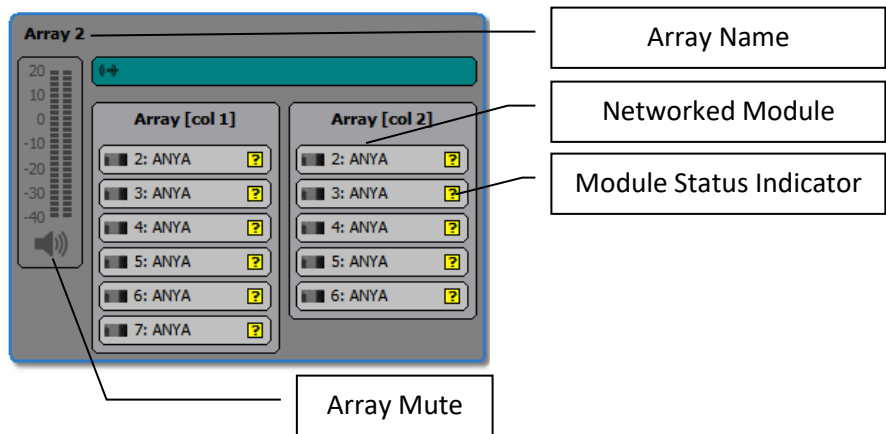

You can edit the X,Y,Z physical location, Min Trim, Max Hang and Aim Angle in the **Properties** pane while that Array is selected.

If you have created a venue and arrays in Resolution, then “virtual” Arrays and Modules in your model will be displayed in the **Network Configuration View** as grey boxes. Each module in the array will have a small indicator square that reports each module’s status.

- A question mark indicates that no physical module has been associated with the module in the model.
- A Yellow box indicates a module that has gone offline.
- A Red box indicates a module previously assigned that was not found upon reconnecting to the Network.
- A box that occasionally flashes Green indicates the module is successfully communicating with Resolution.

Unassigned modeled Arrays will have the list of modules or loudspeakers included in the Array while non-arrayed loudspeakers will be shown as individual boxes with only

one device listed. Arrays will be shown with the modules in Columns and the meters.

A *physical* Adaptive NTX, or Radius Array in the **Online Devices** list can be assigned or associated with a *modeled* Array in the model by simply clicking on the Array in the list and dragging it on to the appropriate modeled Array.

Note: the physical Array and modeled Array must include the same quantity and arrangement of modules).

For example, assume your model includes two RSX212L Arrays and you've named them as "Left Array" and "Right Array". You have assembled two, two-module arrays on-site and physically mounted them in the corresponding positions in your model. Click on an Array in the **Online Devices** list, observe which physical array has LED lights turned on (be sure **Auto Identify** is enabled) and drag the Array over and on top of the corresponding Array in the model, i.e., the left physical Array on the "Left Array" in the model.

Proceed with assigning any remaining physical Arrays to modeled Arrays until all Arrays have been assigned.

Assigning Mixed ADAPTive Arrays

When working with mixed Adaptive arrays (for example, arrays containing both Anya and Anna) the mixed array will first need to be created in Resolution, and each column manually assigned by dragging the column in the 'Online Devices' window, into the appropriate column of the array.

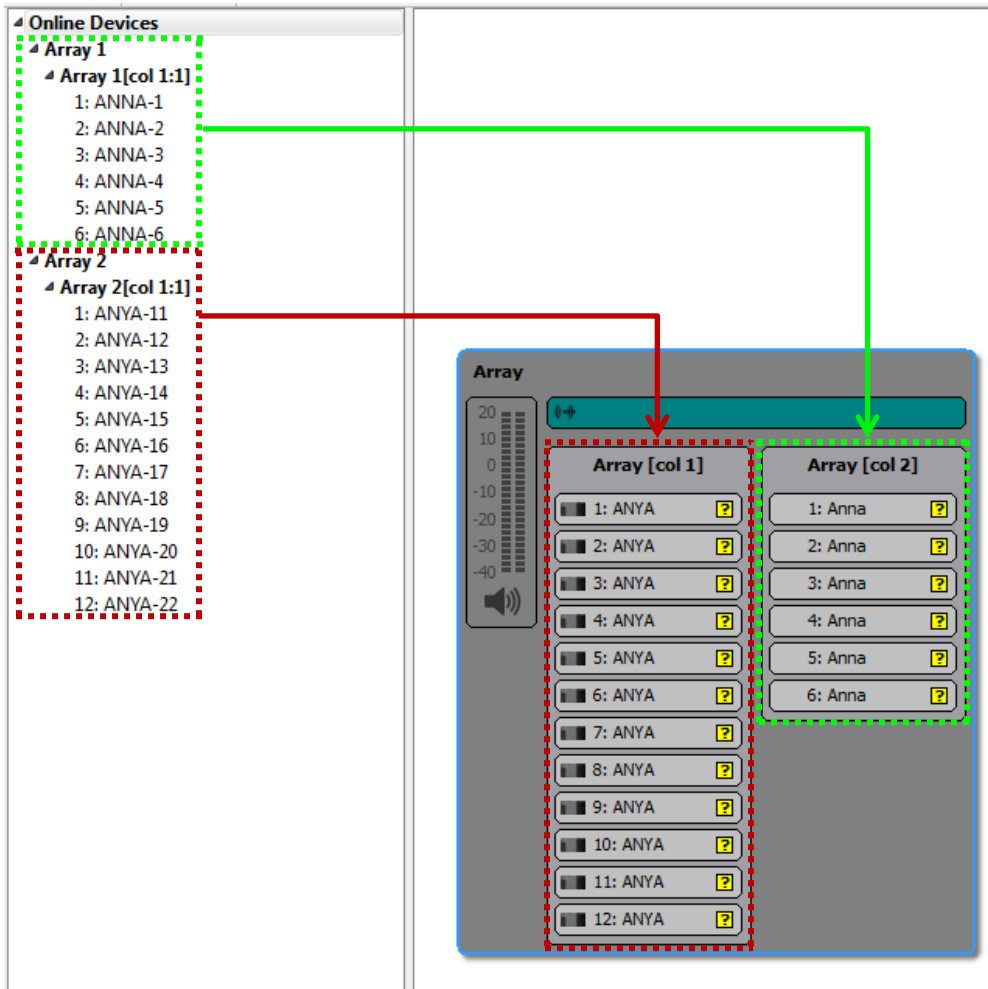

Managing Arrays

Once a physical Array has been associated with a modeled Array, the individual modules listed in the Array will be graphically arranged in Columns and a small square “indicator light” for each module. These indicators will periodically flash green to confirm that Resolution 2 has established active communications with each Anya module.

Clicking an Array in the **Network Configuration Desktop** will display its properties in the **Properties View** window (if you have the **Properties View** window opened) and can be edited as explained in the **Properties View** chapter.

Array Processing can be displayed and edited in real-time by double-clicking the EQ graph at the top of the **Properties View** window.

Right clicking an Array will open a menu with options to open Array Processing, Unassign All, Edit the array (which will launch the Array Assistant), Clone the array, Save Array

Preset, Lock array movement, or Remove array. These mirror functions available in the Project Explorer and Properties panes.

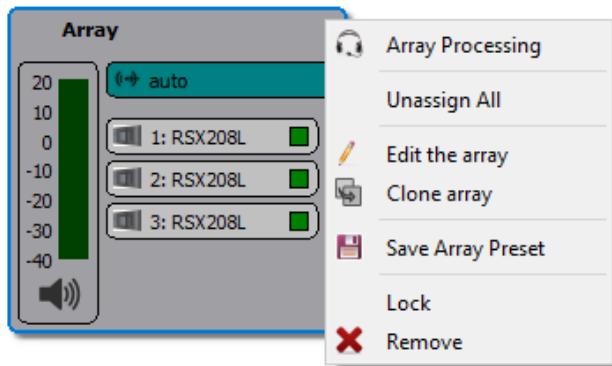

Double clicking the name of an Array will open the **Array Configuration** dialog.

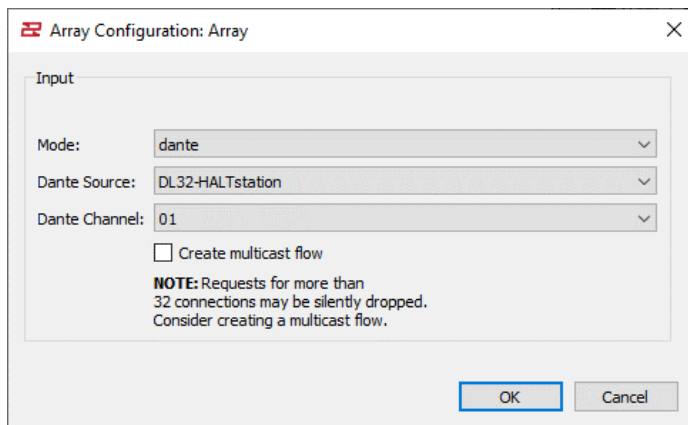

Right clicking a module in an Array will open a menu with options to Insert Item Above, Insert Item Below, Unassign, or Remove Array Item.

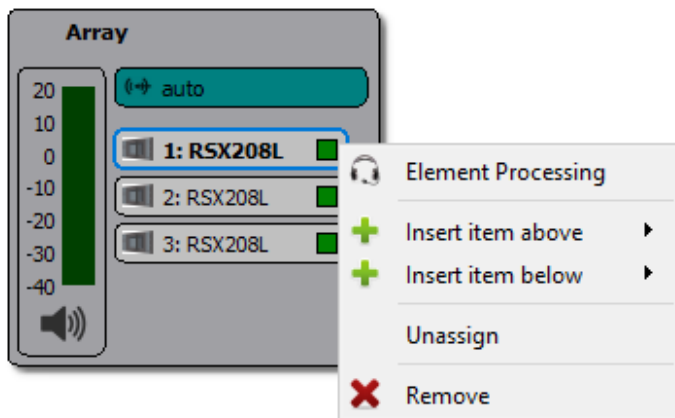

Double clicking a module will open the **Diagnostics Window** for that module

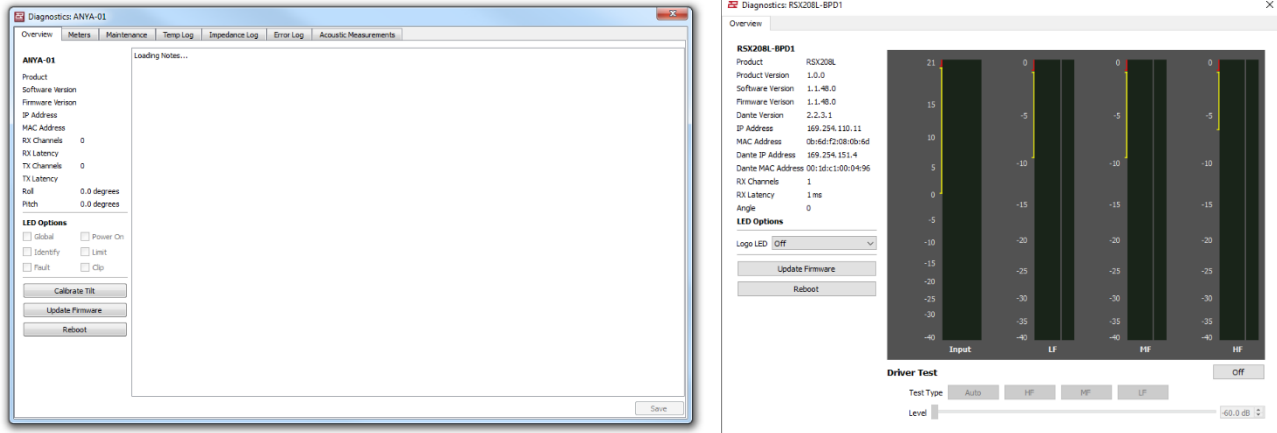

For online networked Radius Modules, it is possible to run a driver test on individual drivers, a group of drivers, or an auto sequence of each driver ending with a full range test.

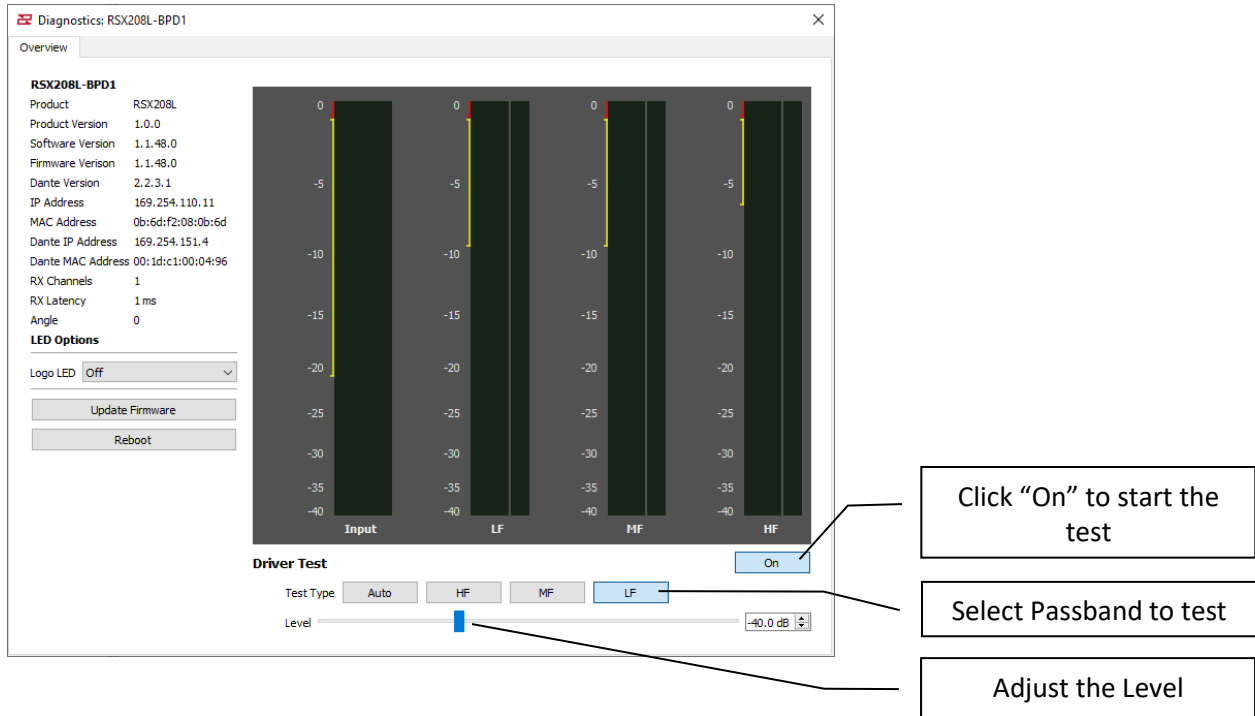

Assigning Inputs

Inputs may be assigned by double-clicking the turquoise-colored bar when the array is populated in network view. This opens the **Input Configuration** dialog box where you can select how you will feed audio to the System. Following are the available options based on the Mode you select:

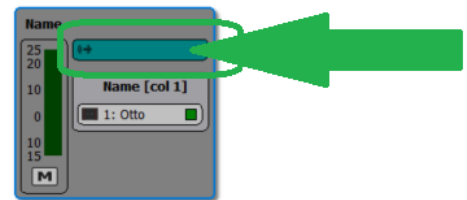

ADAPTive Systems

Mode	Master	Dante Source	Dante Channel
None	N/A	N/A	N/A
Analog	Select which physical Module is receiving the analog audio signal	N/A	N/A
AES L	Select which physical Module is receiving the AES/EBU audio signal (left AES channel).	N/A	N/A
AES R	Select which physical Module is receiving the AES/EBU audio signal (right AES channel).	N/A	N/A
Net	N/A	Select which device, typically the house console or Dante on-ramp device	Select either the Main or Aux Channel
Net Aux	N/A	Select which device, typically the house console or Dante on-ramp device	Select either the Main or Aux Channel

NTX & Radius Systems

None	N/A	N/A	N/A
Auto	N/A	Select which device, typically the house console or Dante on-ramp device. Analog back up is enabled.	Select either the Main or Aux Channel
Analog	Select which physical Module is receiving the analog audio signal	N/A	N/A
Dante	N/A	Select which device, typically the house console or Dante on-ramp device	Select either the Main or Aux Channel

Note: You may receive a yellow banner with a warning that “Network settings out of sync: one or more input modes out of sync.” with **Dismiss and **Select Inputs** buttons, or **Dismiss** and **Sync Now** buttons (depending on which parameters are out of sync). Clicking **Select Inputs** opens the **Input Configuration** dialog box, allowing this parameter to be confirmed for all modules. Clicking **Sync Now** synchronizes the EQ and processing parameters for all modules with the Resolution model.*

WARNING: IT IS CRITICAL THAT ALL PARAMETERS ARE SYNCHRONIZED FOR ADAPTIVE MODULES TO FUNCTION PROPERLY. LISTENING TO ADAPTIVE OR RADIUS ARRAYS WITHOUT FULLY SYNCHRONIZED PARAMETERS OR WITH NETWORK ERRORS MAY PRODUCE UNEXPECTED ACOUSTICAL RESULTS AND IS NOT RECOMMENDED.

Selecting Analog or AES Input (ADAPTive Systems)

Checking the On-ramp box tells the Adaptive Module to transmit the incoming analog or AES-EBU audio signal over the Dante network. Select which input you wish to use, Analog, AES L or AES R, then select which physical Adaptive module will receive the signal. All other modules in the Array will be automatically configured to receive the Dante audio signal from the transmitting module. No further input assignments are required for that Array.

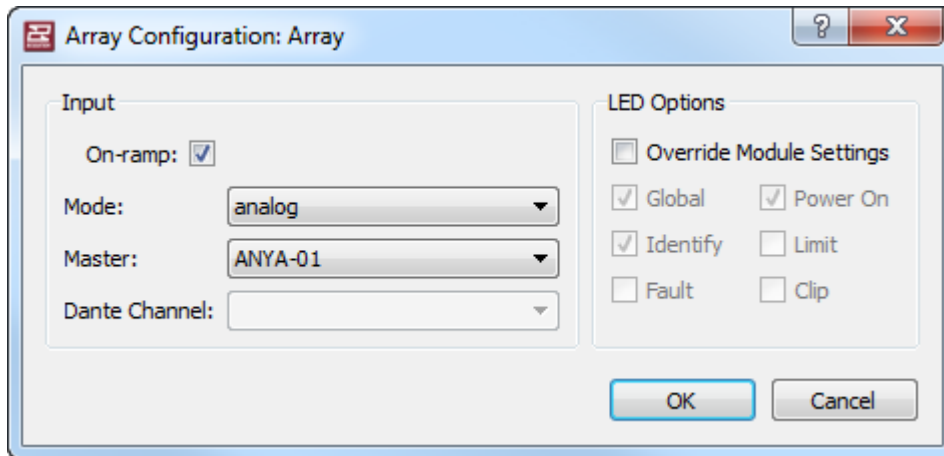

The screenshot shows the 'Array Configuration: Array' dialog box. In the 'Input' section, the 'On-ramp' checkbox is checked. The 'Mode' dropdown is set to 'analog', the 'Master' dropdown is set to 'ANYA-01', and the 'Dante Channel' dropdown is empty. In the 'LED Options' section, 'Override Module Settings' is unchecked, 'Global' and 'Power On' are checked, 'Identify' is checked, 'Limit' is unchecked, 'Fault' is unchecked, and 'Clip' is unchecked. 'OK' and 'Cancel' buttons are at the bottom.

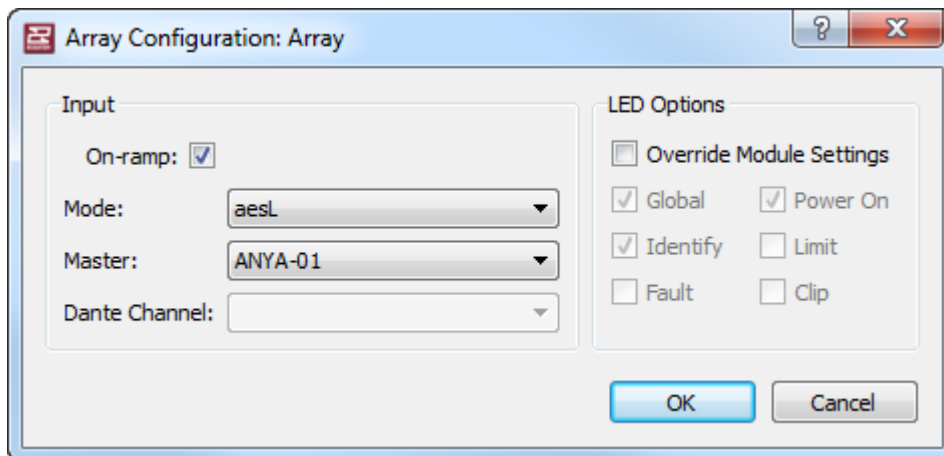

The screenshot shows the 'Array Configuration: Array' dialog box. In the 'Input' section, the 'On-ramp' checkbox is checked. The 'Mode' dropdown is set to 'aesL', the 'Master' dropdown is set to 'ANYA-01', and the 'Dante Channel' dropdown is empty. In the 'LED Options' section, 'Override Module Settings' is unchecked, 'Global' and 'Power On' are checked, 'Identify' is checked, 'Limit' is unchecked, 'Fault' is unchecked, and 'Clip' is unchecked. 'OK' and 'Cancel' buttons are at the bottom.

WARNING: Users should not loop more than two modules with AES/EBU. Doing so will degrade the AES signal resulting in unpredictable behavior.

Selecting the Net or Net Aux Input (ADAPTive Systems)

Un-check the On-ramp checkbox and select which Dante Network you want to use, Net Main or Net Aux, then select which Dante channel you want the Array to receive. This may be an Adaptive module transmitting an Analog or AES input or other Dante on-ramp source such as your Dante equipped digital mixing console. All other Adaptive modules in that Array will automatically be configured to receive the Dante audio signal from that source.

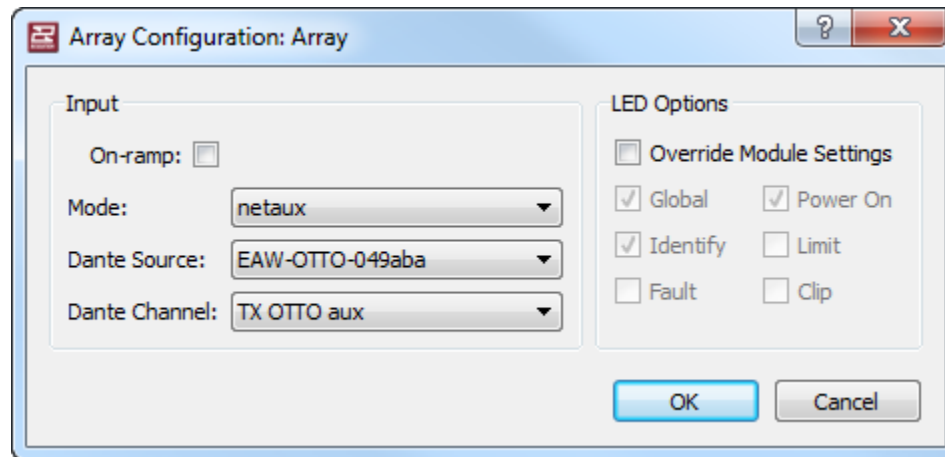
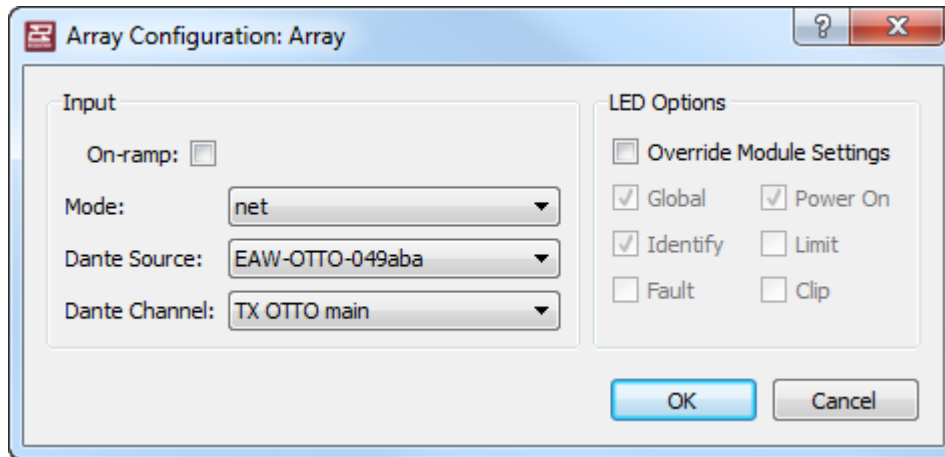

Repeat the Input Source assignment for the remaining Arrays in the system. If the remaining Arrays in the system are to receive the same signal as the first Array, then select **Net**, then the Dante Source transmitting device such as the Anya module receiving the Analog or AES audio Input.

Dry Contact Enable (AC6)

Check box to override module settings. Input Override may be enabled and a pull-down menu allows for selecting a source. Using a GPIO, any incoming signal will then override the default input. Other GPIO options include Preset Select (switch between ADAPtive Presets 1-4) and Fault Reporting.

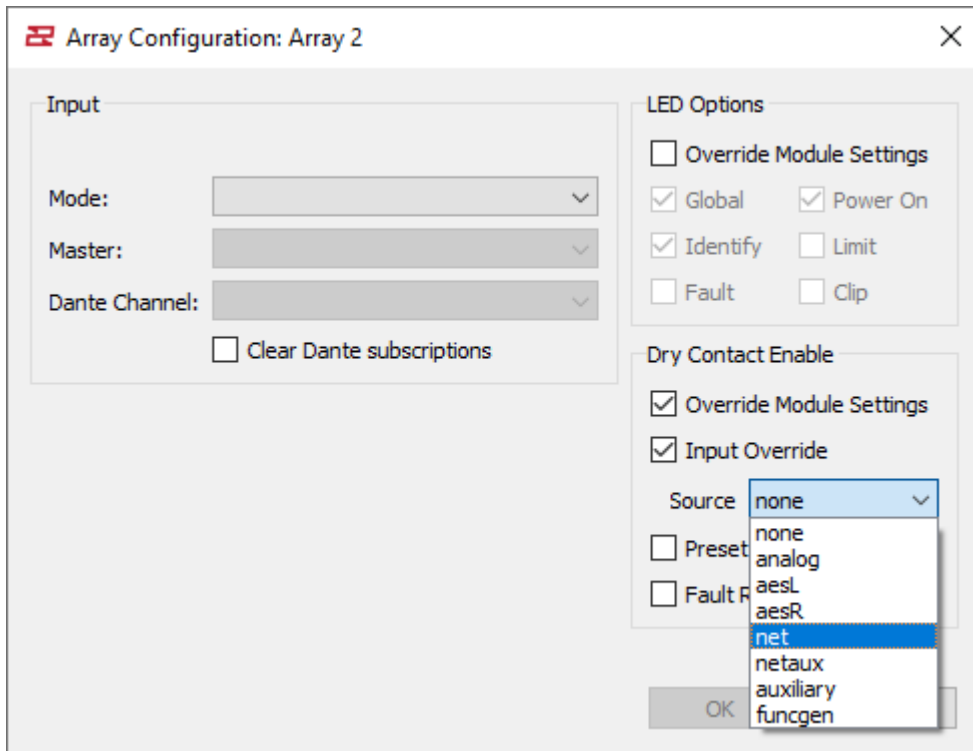

Selecting Auto (NTX & Radius Systems)

Selecting Auto will tell each module to search for a Dante source. Choose which Dante channel you want the Array to receive signal. This may be a Dante module transmitting an Analog or AES input or other Dante on-ramp source such as your Dante equipped digital mixing console. All other Radius modules in that Array will automatically be configured to receive the Dante audio signal from that source. Analog back up is enabled in this mode.

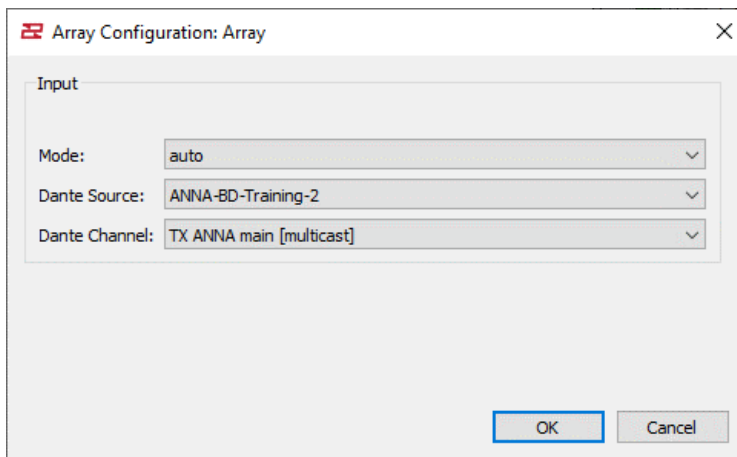

Selecting Analog (NTX & Radius Systems)

The only option for an analog configuration for a Radius system is to select analog from the Mode pull down. This changes each input assignment to the XLR Input/Thru connections per module.

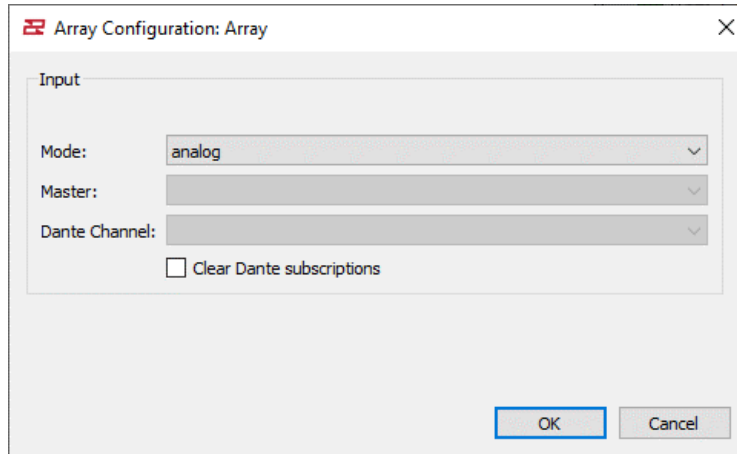

Selecting Dante (NTX & Radius Systems)

Select which Dante source you want to use then choose which Dante channel you want the Array to receive signal. This may be a Dante module transmitting an Analog or AES input or other Dante on-ramp source such as your Dante equipped digital mixing console. All other Radius modules in that Array will automatically be configured to receive the Dante audio signal from that source.

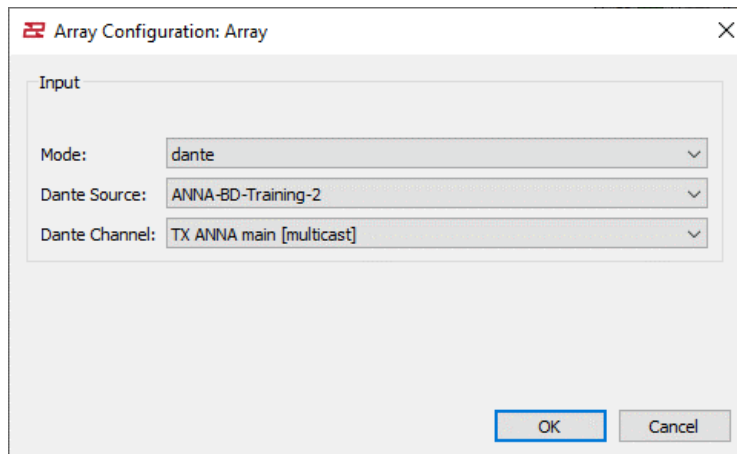

Adaptive Systems Diagnostics Window

Any connected Adaptive module may be monitored and managed by double-clicking the individual modules in each Array. This opens the **Diagnostics** window for the selected module shown below:

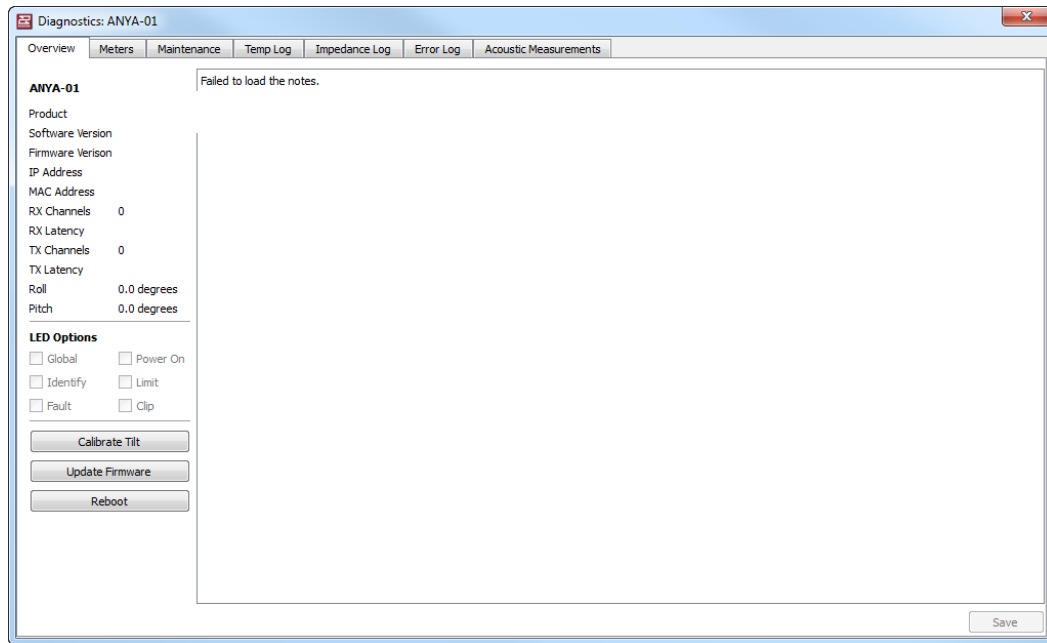

The Overview Tab

The **Diagnostics** window opens to the **Overview** tab. This displays information about that specific module's electronics unit including:

- The module's Network Name
- The Product Name
- The currently installed Software Version
- The currently installed Firmware Version
- The currently assigned IP Address
- The unique MAC Address of the module
- The available RX channels
- The RX latency
- The available TX channels
- The X axis Tilt angle
- The Y axis Tilt angle
- A field for entering any relevant information you wish to record about the module such as the S/N of the loudspeaker the module is installed on, dates any transducers that have been replaced, dates of service and service performed, date of the last maintenance performed, etc.

The Meters Tab

The **Meters** tab displays the levels of each amplifier channel in real-time along with a Gain Reduction meter to indicate any system limiting. The meter is scaled in a "VU" format to emulate traditional analog metering.

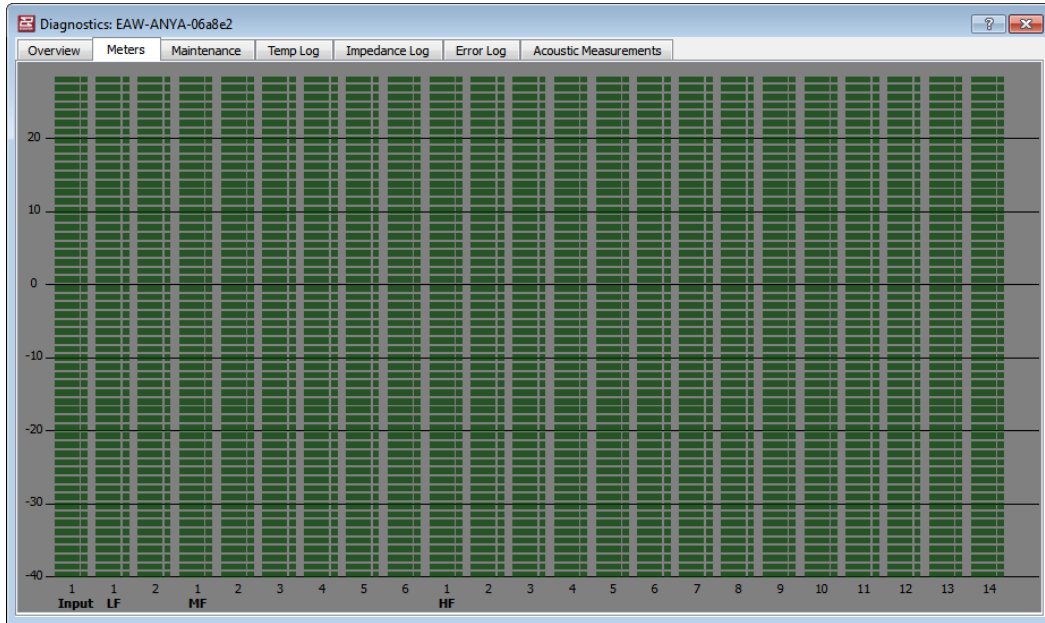

The Maintenance Tab

The **Maintenance** tab displays the current Amplifier Temperature (in SI or US units based on the settings in Resolution 2 Options), calculated Impedance, Amp Protect status and Amp Status for each amplifier channel in the module.

The screenshot shows the "Maintenance" tab selected in the "Diagnostics: EAW-ANYA-06a8e2" window. The table displays the following data:

	Amp Temp.	Amp Impedance	Amp Protect	Amp Status
LF1	104°F	128	<input type="checkbox"/>	OK
LF2	104°F	128	<input type="checkbox"/>	OK
MF1	106°F	128	<input type="checkbox"/>	OK
MF2	111°F	128	<input type="checkbox"/>	OK
MF3	106°F	128	<input type="checkbox"/>	OK
MF4	111°F	128	<input type="checkbox"/>	OK
MF5	100°F	128	<input type="checkbox"/>	OK
MF6	111°F	128	<input type="checkbox"/>	OK
HF1	109°F	128	<input type="checkbox"/>	OK
HF2	109°F	128	<input type="checkbox"/>	OK
HF3	111°F	128	<input type="checkbox"/>	OK
HF4	111°F	128	<input type="checkbox"/>	OK
HF5	111°F	128	<input type="checkbox"/>	OK
HF6	111°F	128	<input type="checkbox"/>	OK
HF7	115°F	128	<input type="checkbox"/>	OK

The Temp Log Tab

The **Temp Log** tab displays a log of operating temperature of each amplifier channel over the previous 24 hours of run time with a Timestamp for each entry in the log. Temperature will be displayed in C even when US units is selected. This tab includes

- **Fetch** button to refresh the log
- **Export** button to export the log to a text file
- **Import** button to allow an exported file to be read.

The **Export** and **Import** buttons are provided primarily to help EAW Support, Service and Engineering troubleshoot problems should they arise in the future.

	Timestamp	LF1	LF2	MF1	MF2	MF3	MF4	MF5	MF6	HF1	HF2	HF3	HF4	HF5	HF6	HF7	HF8	HF9	HF10	HF11	H	
1	Friday, July 26, 2013 11:31:48 AM	40	40	41	44	41	44	39	45	43	43	45	45	45	46	45	46	40	40	35		
2	Friday, July 26, 2013 11:26:44 AM	40	40	41	45	41	45	39	45	43	43	45	45	45	44	46	44	46	40	40	35	
3	Friday, July 26, 2013 11:21:40 AM	40	40	41	44	41	44	39	45	43	43	45	44	44	45	45	45	45	40	40	35	
4	Friday, July 26, 2013 11:16:36 AM	40	40	41	44	41	44	39	45	43	43	45	45	45	44	45	44	45	40	40	35	
5	Friday, July 26, 2013 11:11:31 AM	40	40	41	45	41	45	39	45	43	43	45	45	45	44	45	44	45	40	40	35	
6	Friday, July 26, 2013 11:06:28 AM	40	40	41	45	41	45	39	45	43	43	45	45	45	44	45	44	45	40	40	35	
7	Friday, July 26, 2013 11:01:23 AM	40	40	41	44	41	44	39	45	43	43	45	45	45	45	46	45	46	40	40	35	
8	Friday, July 26, 2013 10:56:19 AM	40	40	41	45	41	45	39	45	43	43	45	45	45	45	46	45	46	40	40	35	
9	Friday, July 26, 2013 10:51:15 AM	40	40	41	44	41	44	39	45	43	43	45	44	44	44	46	44	46	40	40	35	
10	Friday, July 26, 2013 10:46:11 AM	40	40	41	44	41	44	39	45	43	43	45	45	45	44	46	44	46	40	40	35	
11	Friday, July 26, 2013 10:41:07 AM	40	40	41	44	41	44	39	45	43	43	45	45	45	45	46	45	46	40	40	35	
12	Friday, July 26, 2013 10:36:03 AM	41	41	41	44	41	44	39	45	43	43	45	45	45	44	45	44	45	40	40	35	
13	Friday, July 26, 2013 10:30:59 AM	41	41	42	44	42	44	39	45	43	43	45	45	45	44	46	44	46	40	40	35	
14	Friday, July 26, 2013 10:25:55 AM	41	41	41	45	41	45	39	45	43	43	45	45	45	45	46	45	46	40	40	35	

The Impedance Log Tab

The **Impedance Log** tab displays a log of calculated impedance of the load on each amplifier channel over the previous 24 hours of run time with a Timestamp for each entry in the log. This tab includes

- **Fetch** button to refresh the log
- **Export** button to export the log to a text file
- **Import** button to allow an exported file to be read.

The **Export** and **Import** buttons are provided primarily to help EAW Support, Service and Engineering troubleshoot problems should they arise in the future.

	Timestamp	LF1	LF2	MF1	MF2	MF3	MF4	MF5	MF6	HF1	HF2	HF3	HF4	HF5	HF6	HF7	HF8	HF9	HF10	HF11		
1	Friday, July 26, 2013 11:31:48 AM	-	-	-	-	-	-	-	-	-	-	-	-	-	-	-	-	-	-	-	-	
2	Friday, July 26, 2013 11:26:44 AM	-	-	-	-	-	-	-	-	-	-	-	-	-	-	-	-	-	-	-	-	-
3	Friday, July 26, 2013 11:21:40 AM	-	-	-	-	-	-	-	-	-	-	-	-	-	-	-	-	-	-	-	-	-
4	Friday, July 26, 2013 11:16:36 AM	-	-	-	-	-	-	-	-	-	-	-	-	-	-	-	-	-	-	-	-	-
5	Friday, July 26, 2013 11:11:31 AM	-	-	-	-	-	-	-	-	-	-	-	-	-	-	-	-	-	-	-	-	-
6	Friday, July 26, 2013 11:06:28 AM	-	-	-	-	-	-	-	-	-	-	-	-	-	-	-	-	-	-	-	-	-
7	Friday, July 26, 2013 11:01:23 AM	-	-	-	-	-	-	-	-	-	-	-	-	-	-	-	-	-	-	-	-	-
8	Friday, July 26, 2013 10:56:19 AM	-	-	-	-	-	-	-	-	-	-	-	-	-	-	-	-	-	-	-	-	-
9	Friday, July 26, 2013 10:51:15 AM	-	-	-	-	-	-	-	-	-	-	-	-	-	-	-	-	-	-	-	-	-
10	Friday, July 26, 2013 10:46:11 AM	-	-	-	-	-	-	-	-	-	-	-	-	-	-	-	-	-	-	-	-	-
11	Friday, July 26, 2013 10:41:07 AM	-	-	-	-	-	-	-	-	-	-	-	-	-	-	-	-	-	-	-	-	-
12	Friday, July 26, 2013 10:36:03 AM	-	-	-	-	-	-	-	-	-	-	-	-	-	-	-	-	-	-	-	-	-
13	Friday, July 26, 2013 10:30:59 AM	-	-	-	-	-	-	-	-	-	-	-	-	-	-	-	-	-	-	-	-	-
14	Friday, July 26, 2013 10:25:55 AM	-	-	-	-	-	-	-	-	-	-	-	-	-	-	-	-	-	-	-	-	-

The Error Log Tab

The **Error Log** tab displays a log of any errors reported over the previous 24 hours of run time with a Timestamp for each entry in the log. This tab includes

- **Fetch** button to refresh the log
- **Export** button to export the log to a text file
- **Import** button to allow an exported file to be read.

The **Export** and **Import** buttons are provided primarily to help EAW Support, Service and Engineering troubleshoot problems should they arise in the future.

	Timestamp	LF1	LF2	MF1	MF2	MF3	MF4	MF5	MF6	HF1	HF2	HF3	HF4	HF5	HF6	HF7	HF8	HF9	HF10	HF11	
1	Friday, July 26, 2013 11:23:15 AM	Imp Fault	Imp Fault	Pass	Pass	Pass	Pass	Pass	Pass	Pass	Pass	Pass	Pass	Pass	Pass	Pass	Pass	Pass	Pass	Pass	Pass
2	Friday, July 26, 2013 11:20:43 AM	Imp Fault	Imp Fault	Pass	Pass	Pass	Pass	Pass	Pass	Pass	Pass	Pass	Pass	Pass	Pass	Pass	Pass	Pass	Pass	Pass	Pass
3	Friday, July 26, 2013 10:49:47 AM	Imp Fault	Imp Fault	Pass	Pass	Pass	Pass	Pass	Pass	Pass	Pass	Pass	Pass	Pass	Pass	Pass	Pass	Pass	Pass	Pass	Pass
4	Friday, July 26, 2013 10:23:25 AM	Pass	Imp Fault	Pass	Pass	Pass	Pass	Pass	Pass	Pass	Pass	Pass	Pass	Pass	Pass	Pass	Pass	Pass	Pass	Pass	Pass
5	Friday, July 26, 2013 10:19:52 AM	Imp Fault	Pass	Pass	Pass	Pass	Pass	Pass	Pass	Pass	Pass	Pass	Pass	Pass	Pass	Pass	Pass	Pass	Pass	Pass	Pass
6	Friday, July 26, 2013 9:19:44 AM	Start up																			
7	Wednesday, December 21, 1988 1:26:49 AM	Start up																			
8	Tuesday, December 20, 1988 6:24:24 PM	Start up																			
9	Monday, December 19, 1988 2:17:01 AM	Start up																			
10	Monday, December 19, 1988 2:11:50 AM	Start up																			

The Acoustic Measurements Tab

The **Acoustic Measurements** tab provides the Adaptive self-diagnostics functions. The window lists all the transducers with Solo, Sweep select box and Progress status for each transducer along with Calibrate (Anya only), Measure, and Cancel buttons.

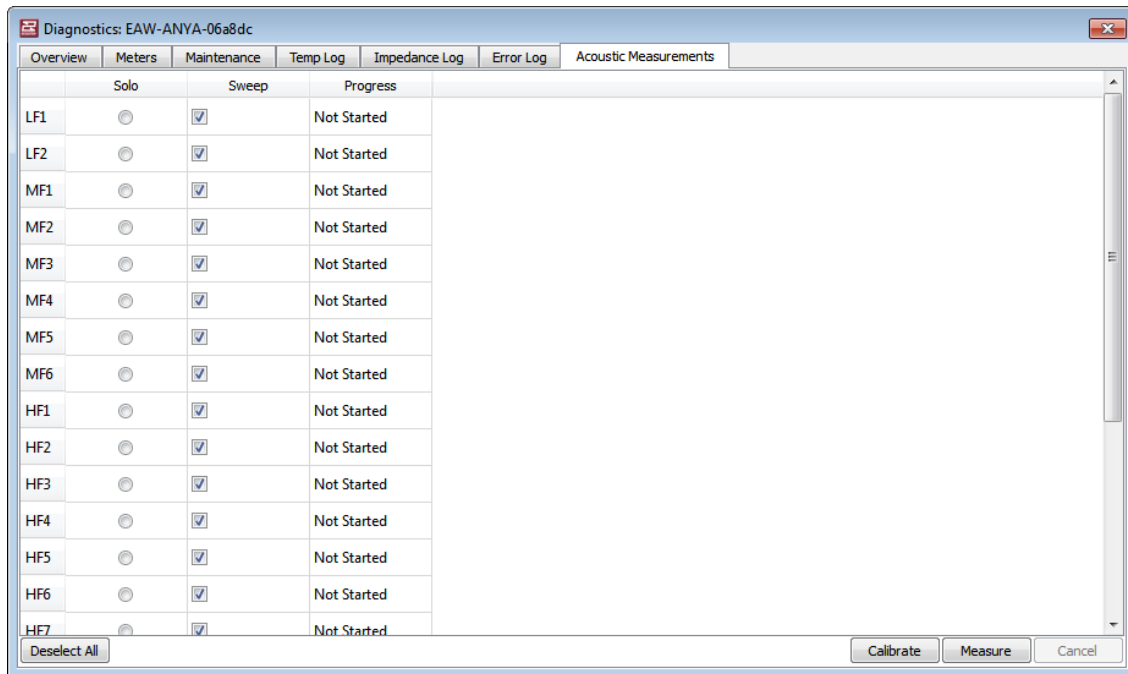

As with any dual FFT measurement system, performing Calibration and diagnostic Measurements should only be performed in a relatively quiet space. Excessive ambient noise can cause measurement errors and inconsistencies.

Calibrate (Anya only)

Calibrate allows you to create new reference response measurements for diagnostic use with Anya. This should be used whenever an Anya transducer has been replaced.

Select which transducer you need to calibrate and click the **Calibrate** button. Anya will generate a short noise burst and capture frequency response measurements with the internal microphone. It will perform the measurements three times for each transducer to ensure the measurements are valid and have not been contaminated by excessive external noise. If the measurements are not consistent, then the measurements will be repeated. Total time to complete the process for all transducers in an Anya module will be about 5 minutes.

**Note: The noise burst stimulus will sound like a “popping” noise due to the extremely short duration. This is normal and should not be interpreted as any fault in the system.*

Measure

Measure allows you to perform diagnostics to check the health of an Adaptive module. To start the diagnostics function, check the Sweep box for each transducer you wish to measure, and click the Measure button. The module will perform the measurements and compare with the reference stored in the internal memory. Resolution 2 will then display a Pass or Fail result for each transducer.

Cancel

Clicking **Cancel** during a Calibrate or Measurement routine will stop the measurement.

System Health

In the event faulty cells are detected in an Adaptive Module (or even if an entire module is offline), Resolution gives the user the ability to heal around these when the **Upload Array Parameters** box is selected.

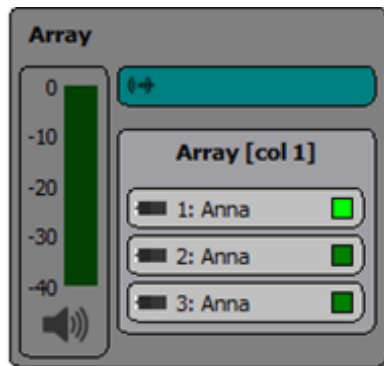

When the user opts to 'exclude these modules and recalculate', Resolution will generate a new acoustical model, taking into account the faulty cells or missing module, and optimize the sound system available. Once an option is chosen and the network is refreshed, the dialogue will not appear until the modules in the system unassign, then reassign accordingly.

If a fault is detected within a specific module due to either an amplifier or transducer failure, Resolution gives the user the ability to exclude the faulty cells from the parameter calculation, optimizing the system for this condition.

To view the current status of system health, double click the highlighted area seen below at the bottom right hand corner of the Resolution window.

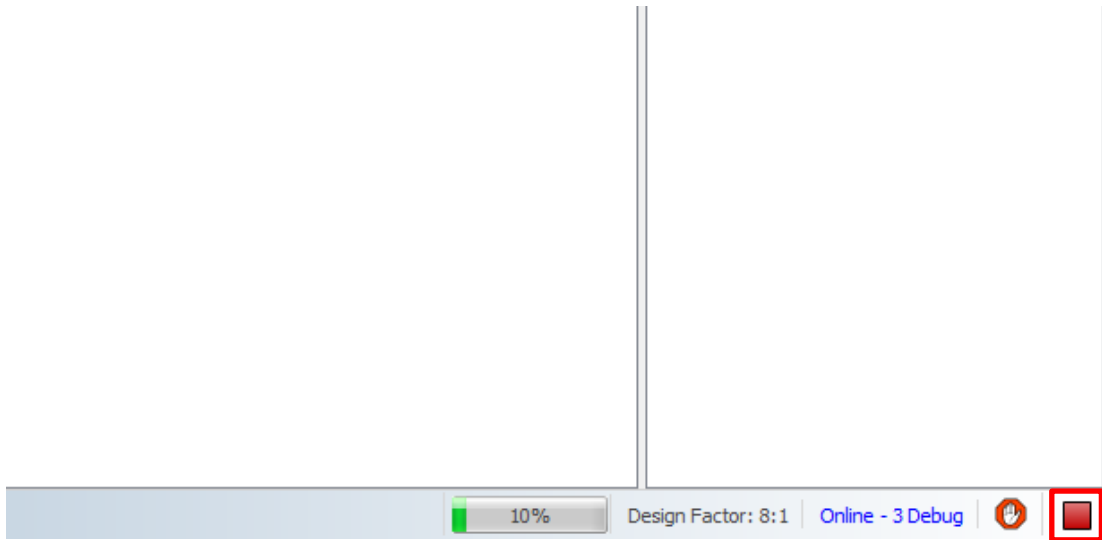

If any module is highlighted red, the system needs healing. If the module appears as yellow, this indicates a fault resulting in a difference of less than 1 dB down, needing examination later. Yellow does not present any audible issues.

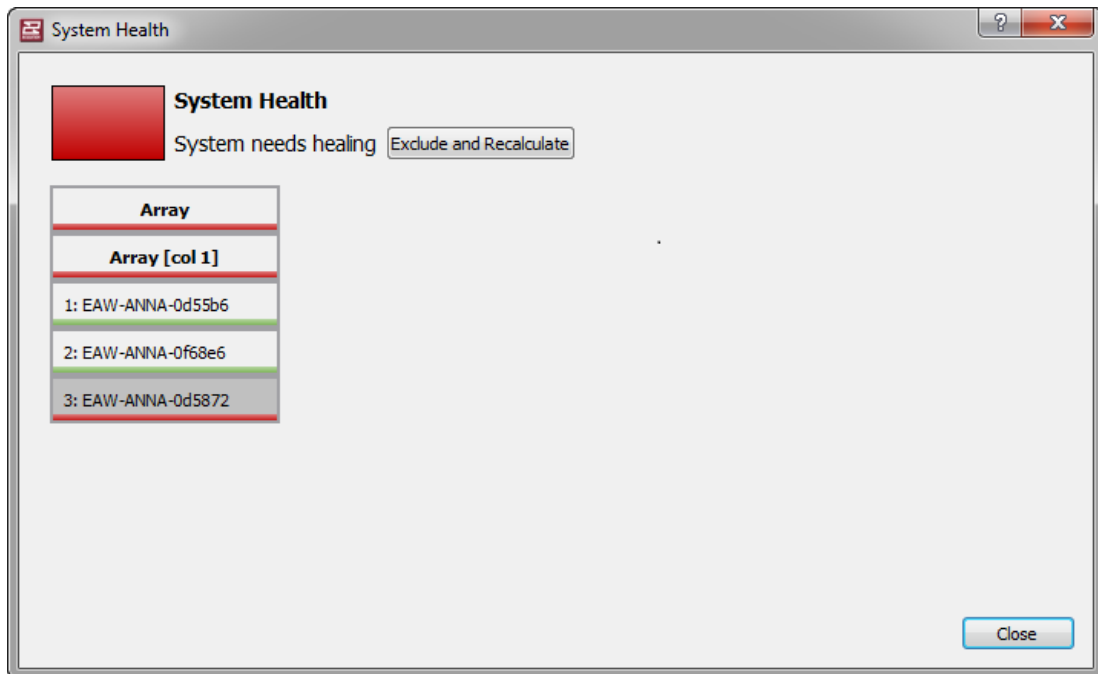

If all modules are highlighted green, the system is at 100% health and ready to use.

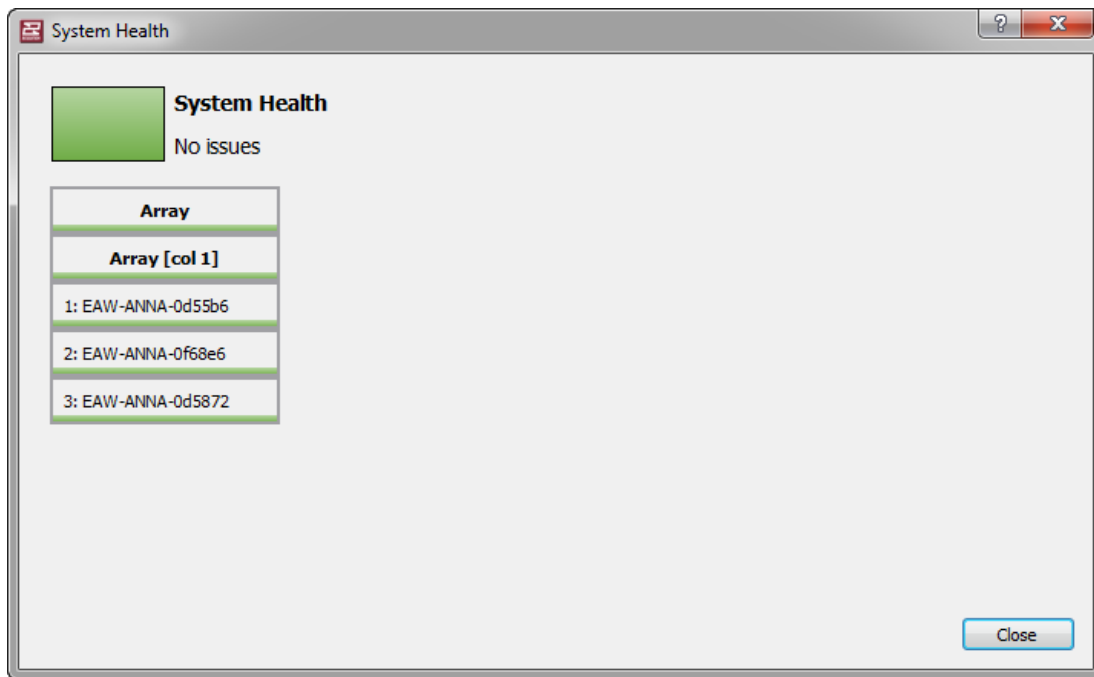

Monitor Only Mode

In Monitor Only mode, the ability to modify a system is limited. This mode is useful after a system has been setup and you wish to prevent others from adjusting settings or parameters.

toggling Monitor Mode on will disable Design View and place Resolution in Network View. The Properties window is hidden so that property changes to arrays and the venue cannot be made. Uploading parameters and making preset changes are also disabled. System Health messages and the ability to heal a system are also disabled.

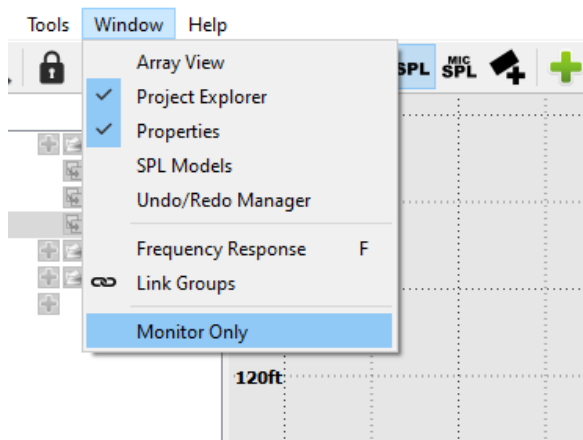

Monitor Mode can be enabled and disabled using the Monitor Only menu item under the Windows menu. The current monitor mode will be saved, in the current user settings, so that Resolution will open in the same mode when it is run again.

Going Online with UXA Amplifiers

Before going online, ensure the computer being used is connected to the same Ethernet network as the amplifier.

NOTE: If amplifier is on a DANTE Network consisting of more than 2 multicast flows, communication issues may occur. As such, EAW amplifiers are only supported on DANTE networks with 2 or less multicast flows.

When first opening Resolution, start by switching to **Network Configuration View**.



To add an amplifier or processor to the system, click on the "+" symbol next to Processors & Amplifiers in the Project Explorer window.

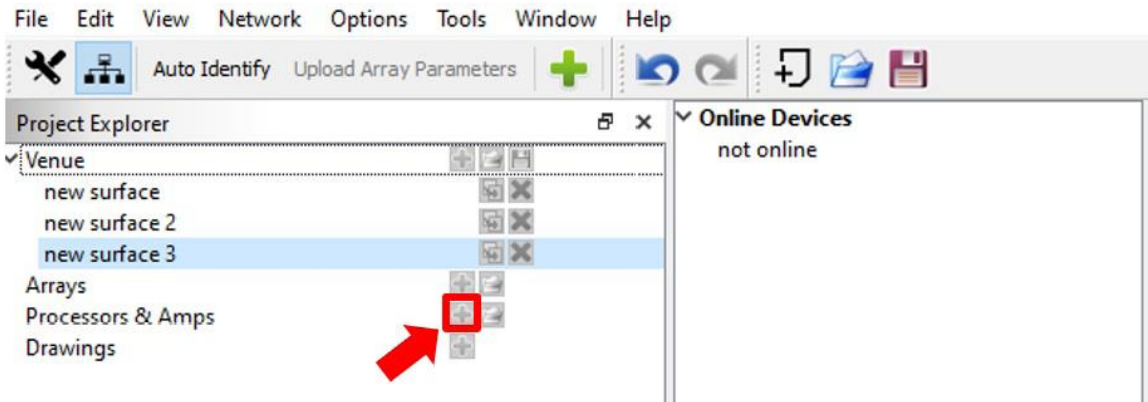

Upon being prompted, choose a name and a product from the devices available. Click "OK" once complete.

The selected device will now be loaded into the system. In this case, as offline.

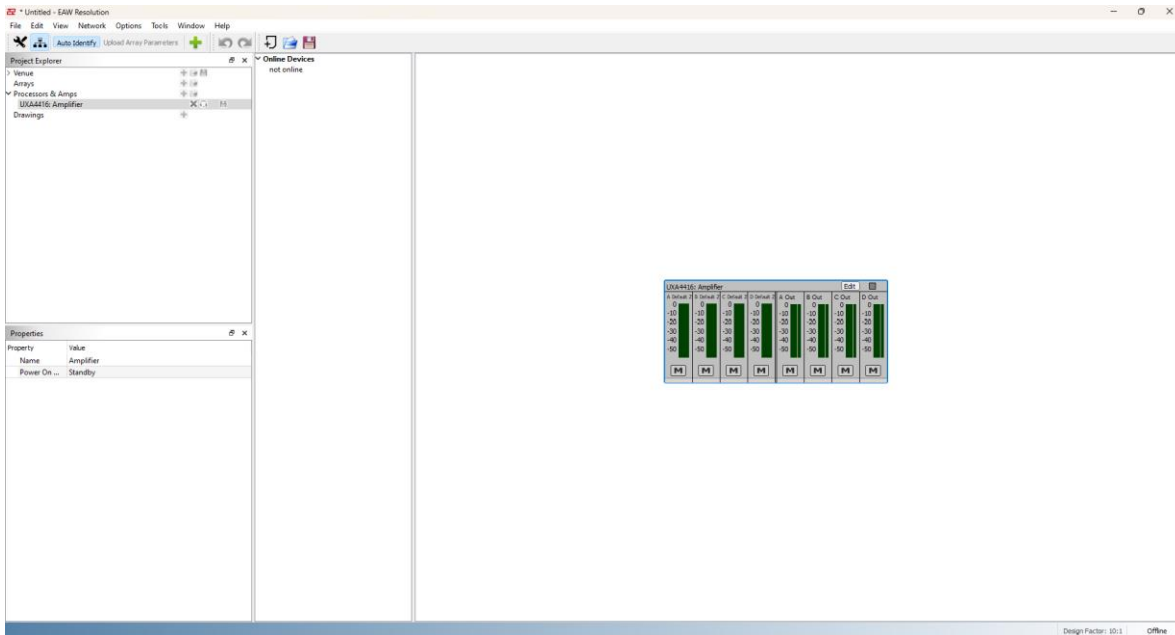

To connect the processor or amplifier to the system, start by clicking **Network > Connect**.

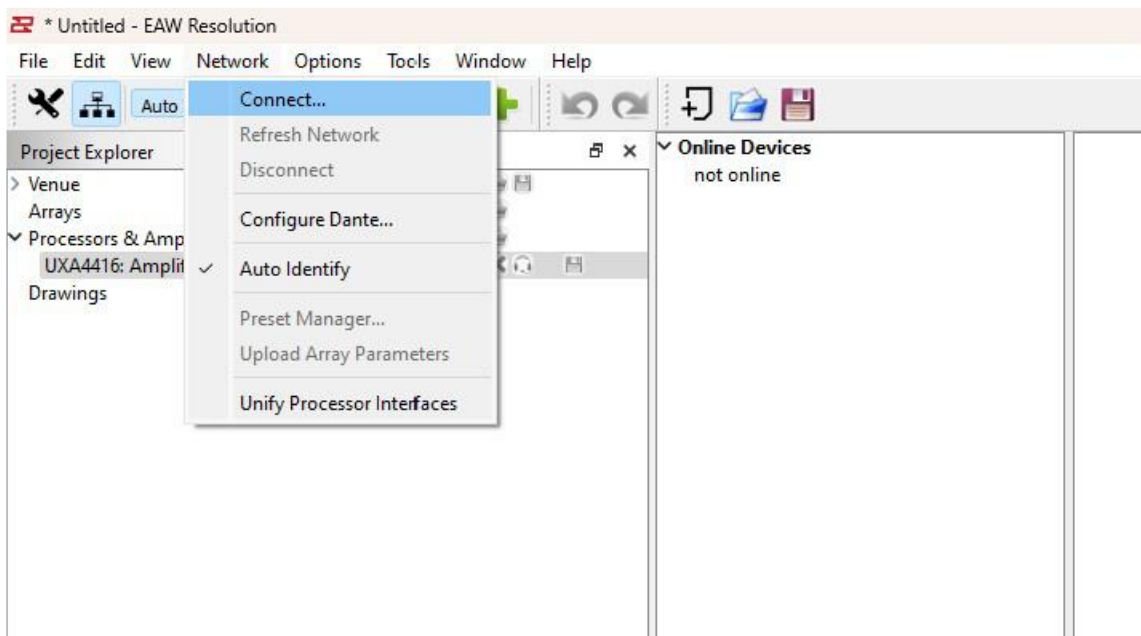

After a quick scan, all available products will now appear listed under **Online Devices**. Click and drag each detected device and drop it over the top of previously set up offline devices.

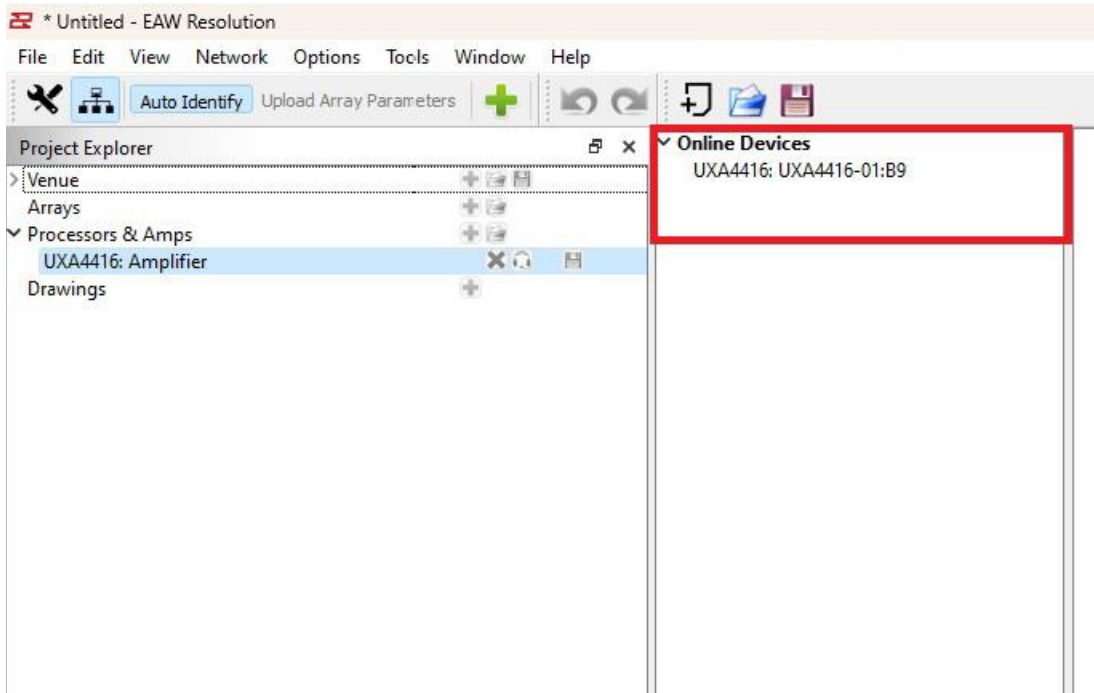

A prompt may appear if Resolution is not in sync with the device. Choose whether to push the Resolution settings to the device, pull to use the settings on the amplifier, or cancel to use the last known setting.

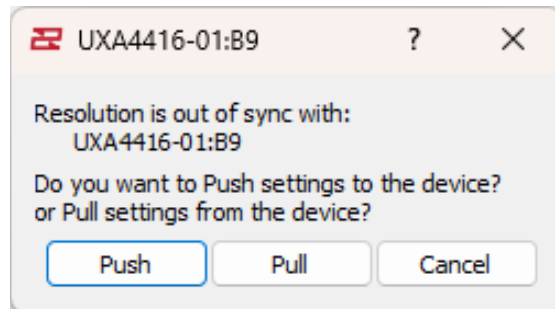

At this point, the device is online and ready to use in the system (as indicated by the green light).

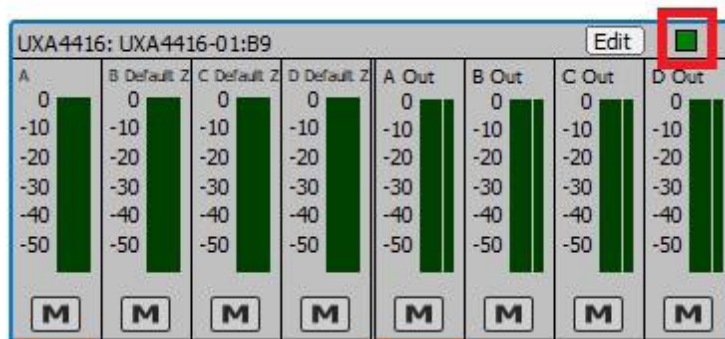

UXA4416 Input & Output Configuration

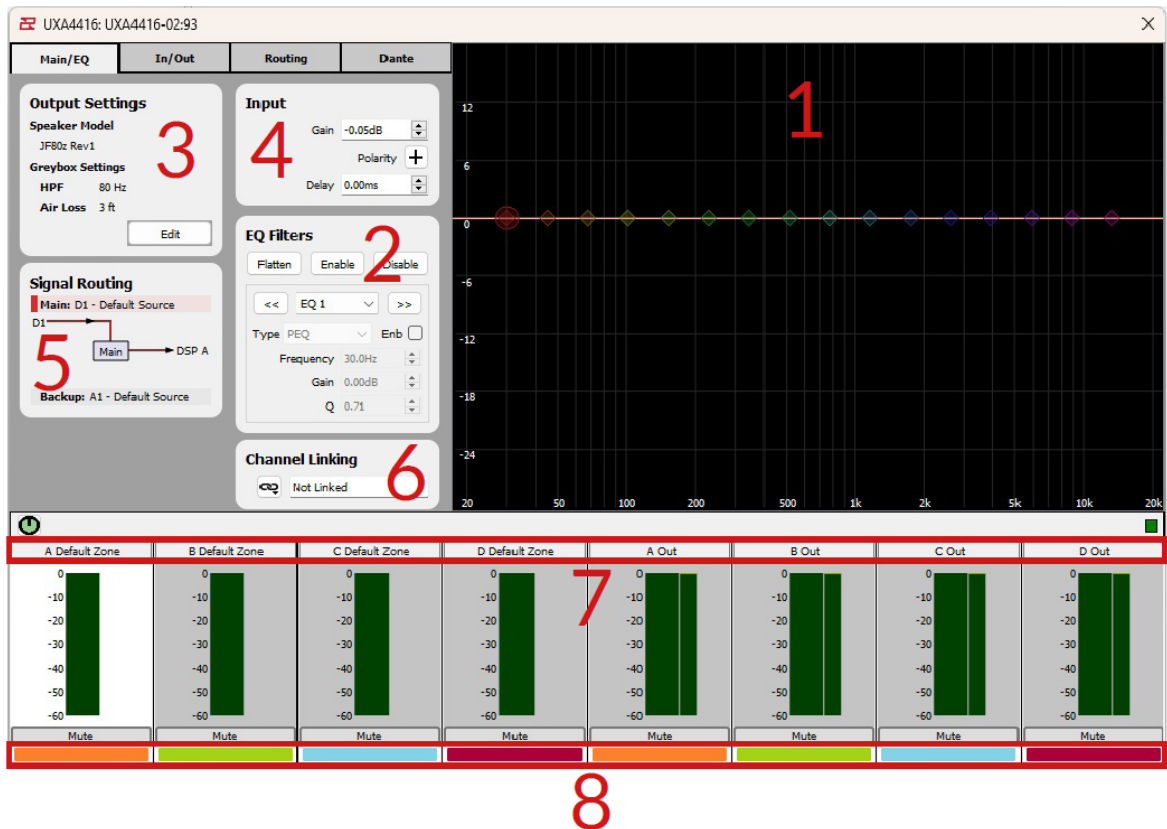

- EQ/Filter Graphic Window:** Click and drag functionality to control a Low/High Pass Filters, Low/ High Shelf EQs, and (6) PEQ Filters. Clicking the right facing arrow at the top corner expands and hides the detail pane. Each EQ band will need to be enabled manually. Once a Greybox is loaded, only the HPF may be modified.
- EQ/Filters Section:** Manually adjust settings for all EQ/Filter bands. Use << >> buttons to navigate from one band to the next. There is an additional pull-down menu to choose type of filter. Once a Greybox is loaded, only the HPF may be modified.
- Output Settings:** Select and configure EAW Greybox in amplifier.
- Input:** Adjust gain and delay, with an option to invert polarity per channel.
- Signal Routing:** Configure analog and Dante inputs, choose routing mode, then main and back up input per channel. User adjustable channel gain and delay available.
- Channel Linking:** Link EQ, gain, mute, delay, invert between input channels.
- Input & Output Channels:** Signal meters and channel labels. To change a channel label, double click on the default letter/number and type in a friendly name. **NOTE: Output channels are locked by design as all configuration occurs within Greybox.**
- Input/Output Color Indicators:** An easy method to distinguish which outputs are utilizing which input source (Assigned output channels will match the color of input channels).

Loading Greyboxes for UXA4416

To assign a Greybox preset to a channel on the UXA4416, first select an input channel, then click the Edit button under **Output Settings**

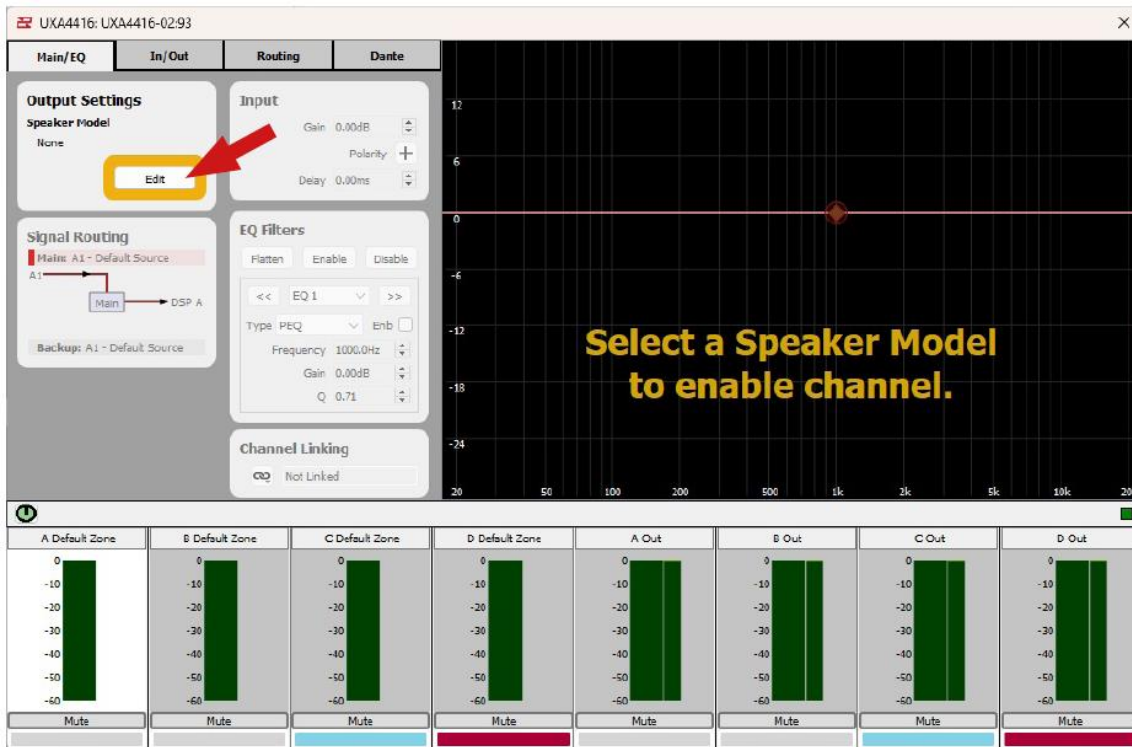

Make a product selection under **Speaker Model**. BI amp greyboxes will, generally, be noted as BI in their name, and will require two channels as either AB or CD. If the new greybox will affect a channel that already has a greybox defined, then a warning dialog will be shown. When selecting a new speaker model, all EQ and input settings will be reset on the affected channels.

Once a speaker model has been chosen. A number of options will become available for modifying the sound. Usually, these settings include HPF, Array Size, and Air Loss. Additional options include Voicings and a Speaker Model refinement if the greybox is designed for a speaker family. Click **Apply** when finished.

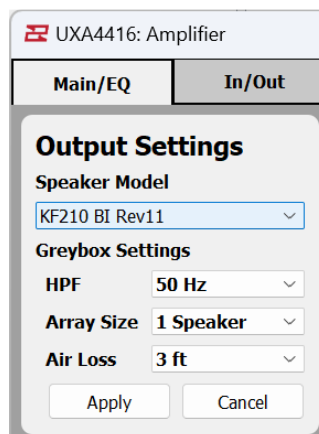
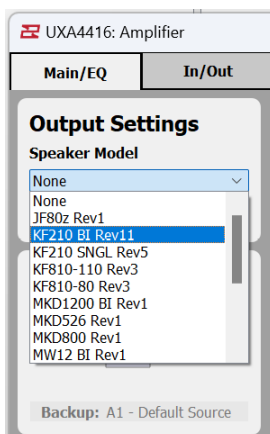

Once the greybox has been applied, **Output Settings** will show the current greybox and the audio meters will show which channels are affected by the new greybox. Here, a BI amp greybox has been applied on channels AB. The input meters are combined into one, and the title now indicates AB. The color labels on the bottom show input channel AB and output channels A(LF Out) and B (HF Out) in orange, indicating they are tied together.

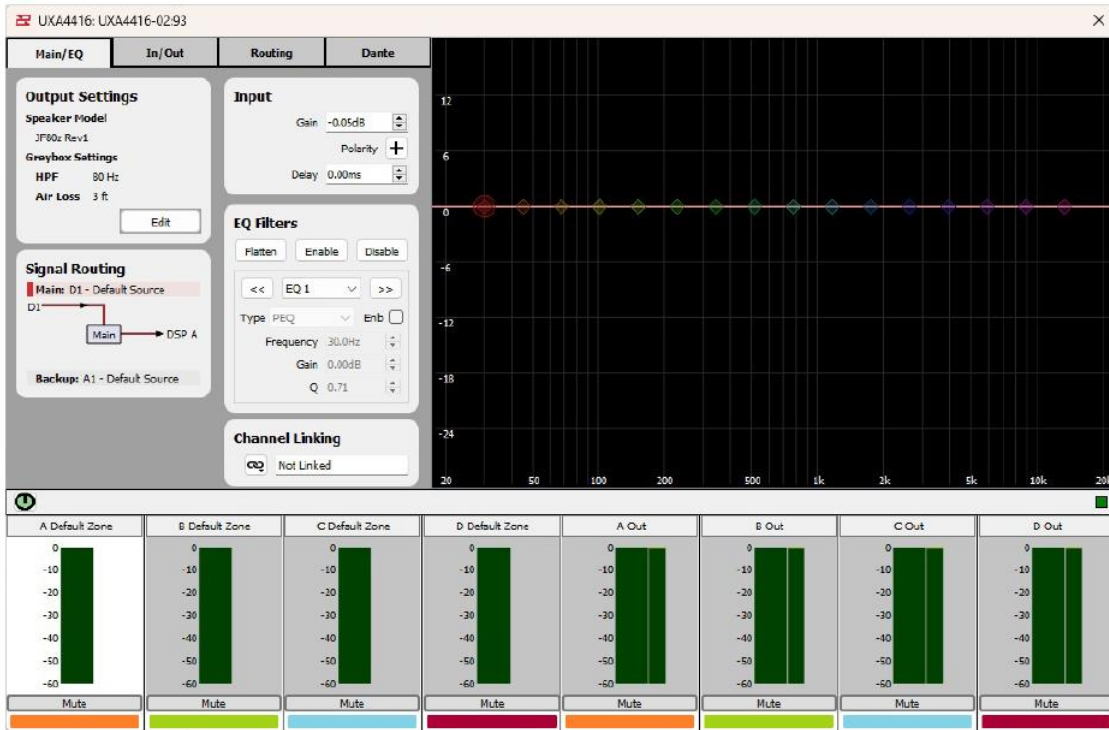

Note that if a BI amplified greybox is loaded, both input channels will be joined. (AB & CD). Inputs A & B correspond to the top NL4 connector on the amplifier back panel, whereas C & D correspond to the bottom connector.

Configure **Inputs/Dante** once Greybox has been configured

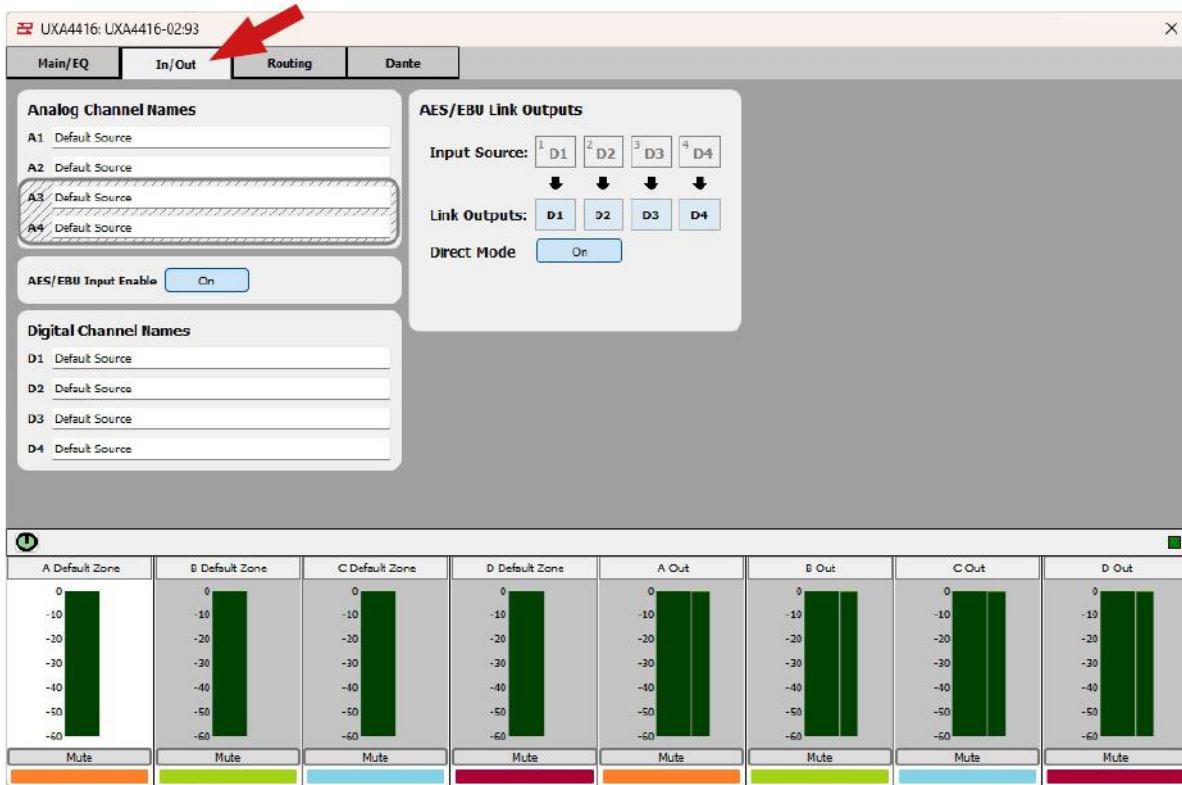

When using Analog, ensure that AES/EBU enable is turned off. Inputs A1-A4 will be available and selectable in the routing section. Digital inputs D1-D4 will be greyed out, as not available since they share the same connector as Analog A3-A4 shown as greyed out.

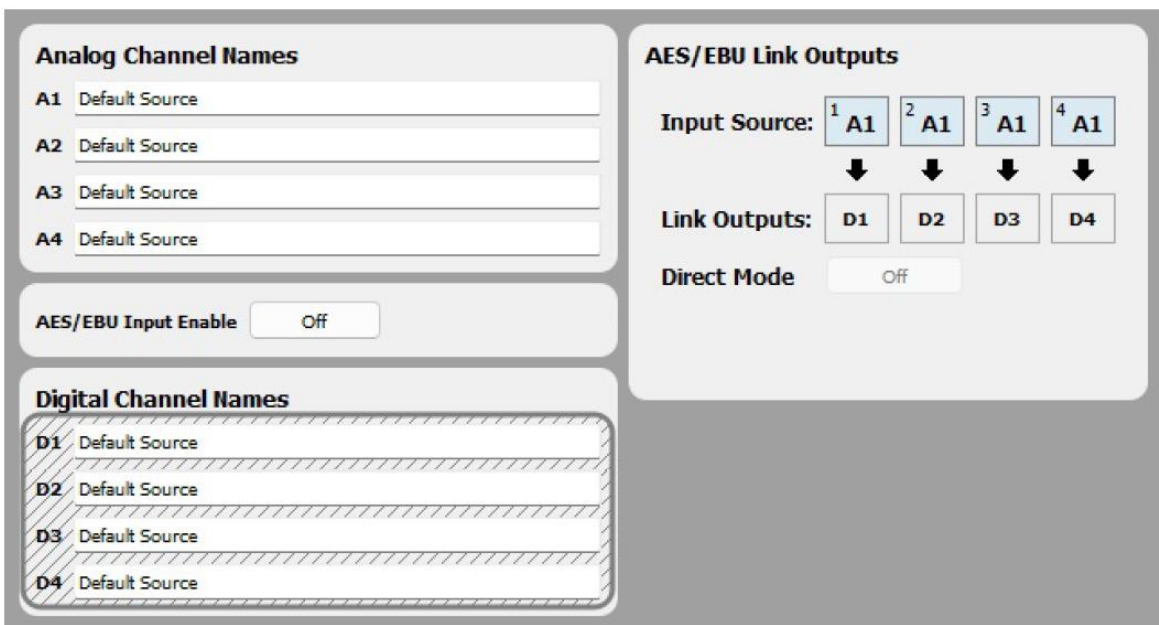

When **Enable Digital AES/EBU** is enabled, this allows for inputs D1-D4, disabling A3-A4 for these digital assignment options.

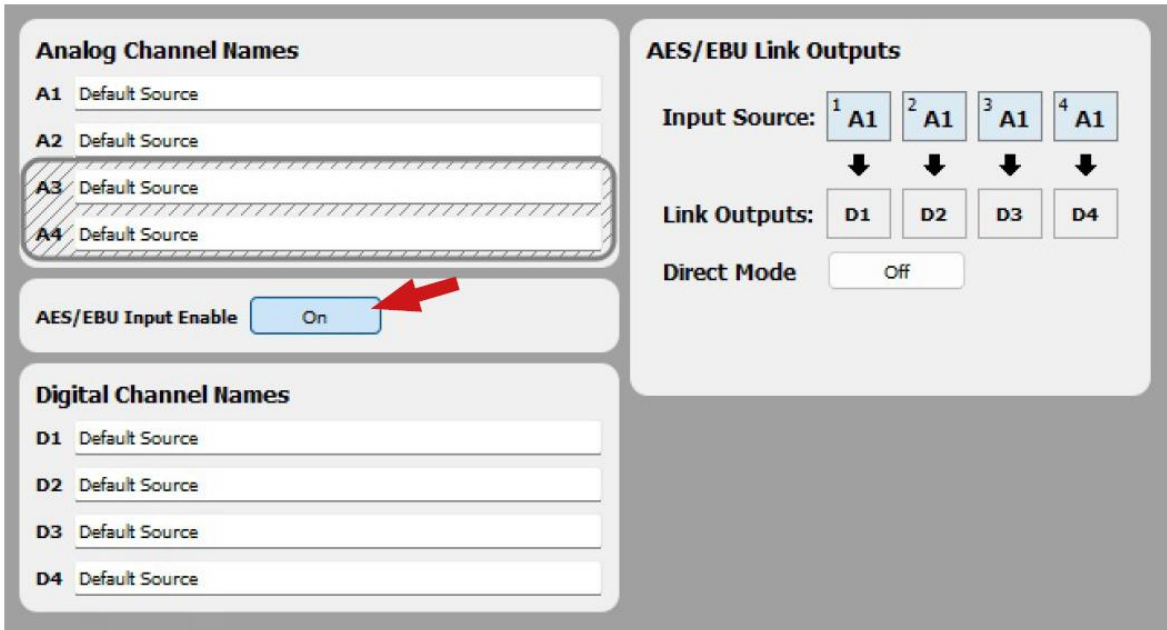

Under **AES/EBU Link Outputs** it's possible to assign an input source to a digital output. On the Input Source line, select a signal to send to the corresponding digital output.

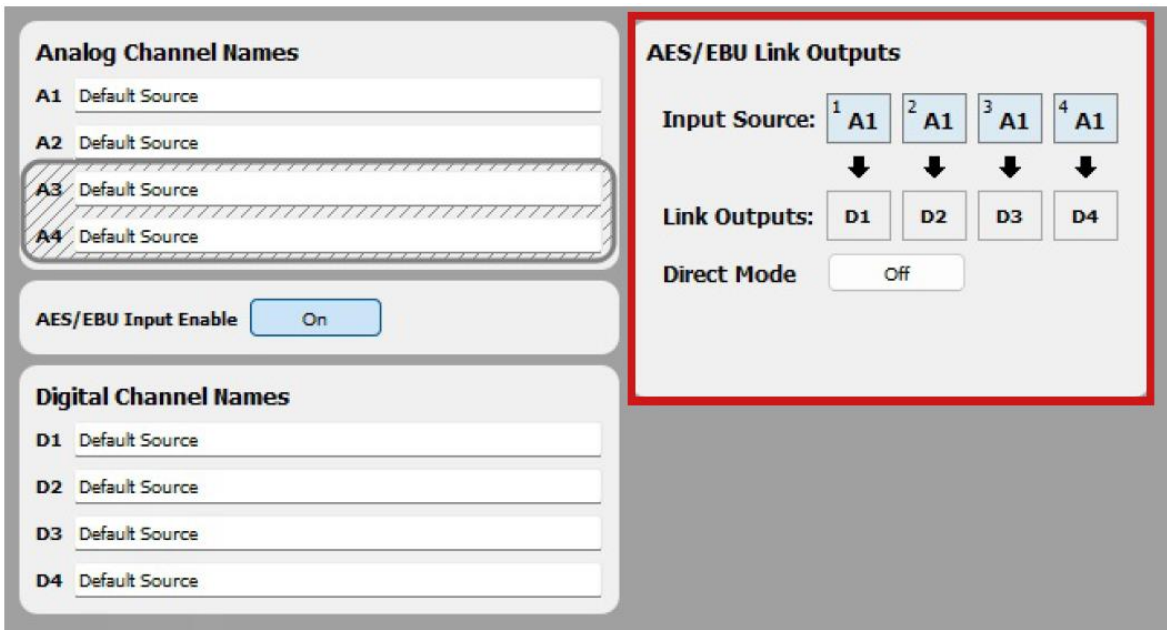

Direct Mode overrides the Input Source selection and sends digital D1-D4 to outputs D1-D4 ends the digital inputs D1-D4 directly to the digital outputs.

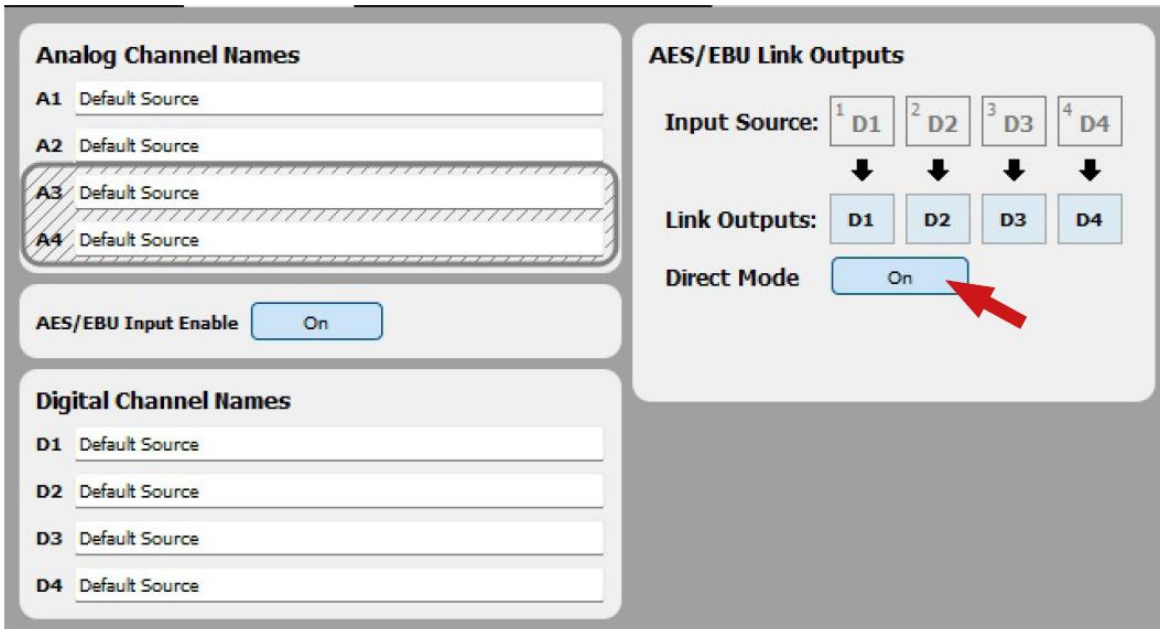

Click on the Dante Tab to assign inputs to available Dante channels

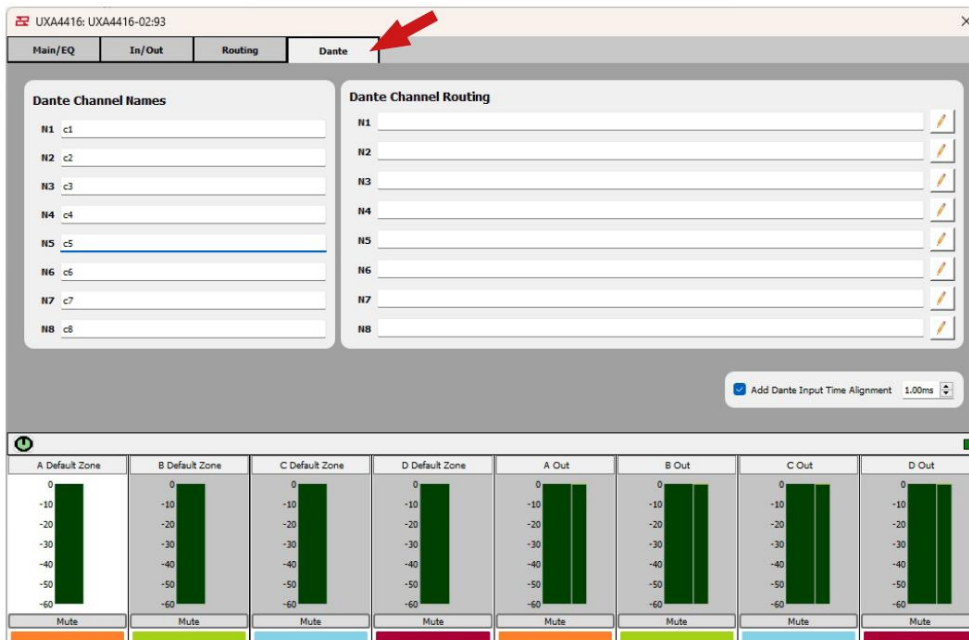

Double click under **Input Name** to rename the input, then select an available channel by clicking on the pencil edit button next to the Dante Channel dialog.

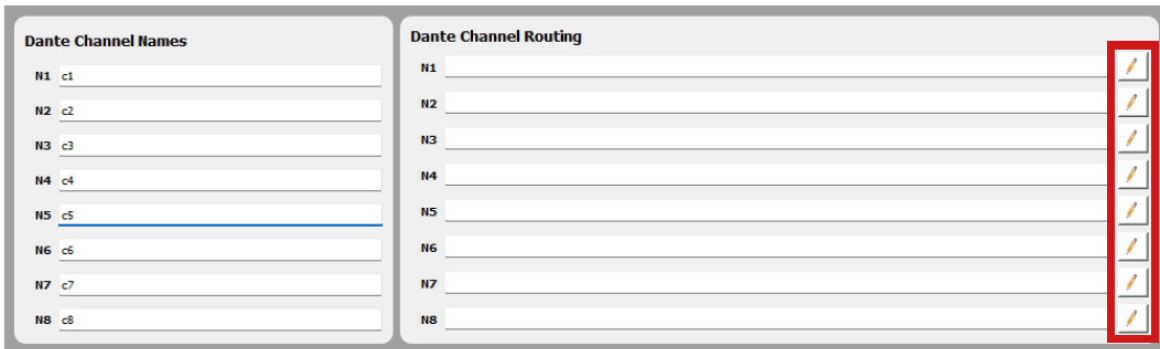

Assign **Signal Routing** once Greybox has been configured (Assign a main and back up input)

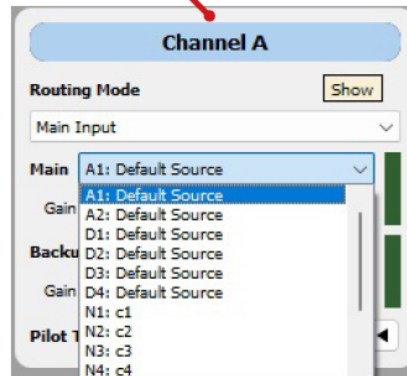
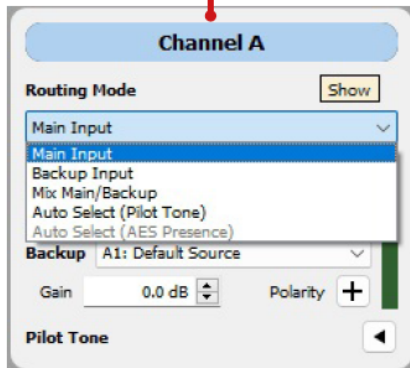
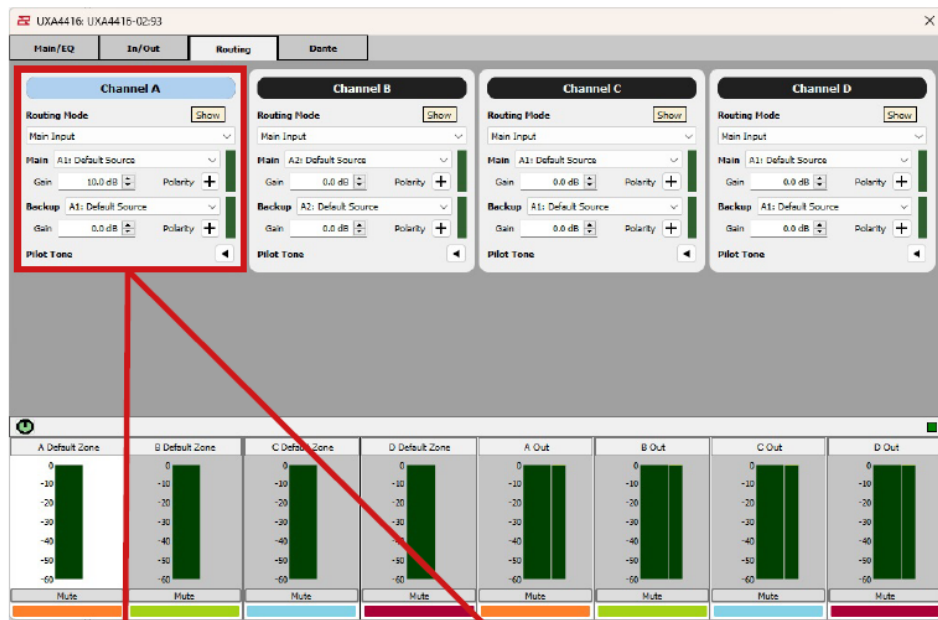

Routing Mode

- Main
- Backup

- Main/Backup
- Auto Select (Pilot Tone) – select the main input if sound is detected at the user specified level.
- Auto Select (AES Presence) – select the main input if an AES signal is detected.

Main Input/Backup Input

- Select Analog or Digital input channel. If a Dante card is installed then additional Dante input channels will be selectable.
- The gain and polarity of the input source can also be adjusted here.

Pilot Tone

- The pilot tone is defined by sampling the Main Input using a notch filter and gating that signal to detect the minimum threshold at which a signal is detected.
- A Notch Filter is also provided to further isolate the signal to a specific frequency and bandwidth (Q).

Note that if bi amplified greybox is loaded, both input channels will be joined. (AB & CD). Inputs A & B correspond to the top NL4 connector on the amplifier back panel, whereas C & D correspond to the bottom connector.

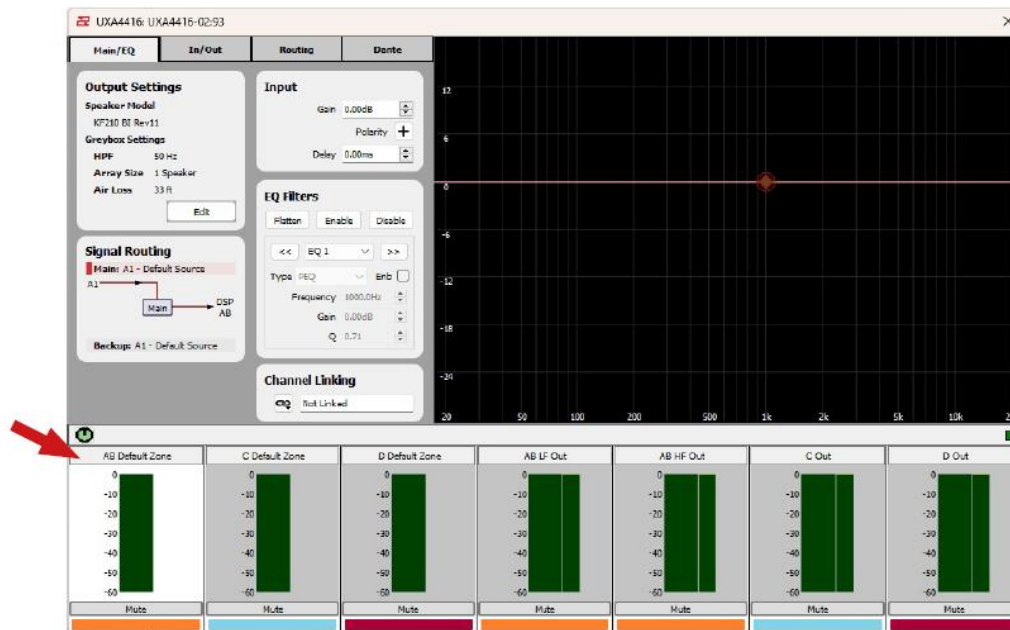

UX4416 Firmware Updates

Firmware updates are released with new versions of Resolution in the form of an EAWFW firmware update file. This file contains components for device firmware, speaker greybox library, and Dante firmware.

From the Tools menu, select **Firmware Manager**. This will open the Firmware Manager dialog which will display known devices on the network.

Click **Select File** and find the UX4416 firmware update file. Any device in the list that can accept the firmware file will become selectable. Click the checkbox next to the UX4416 amplifier.

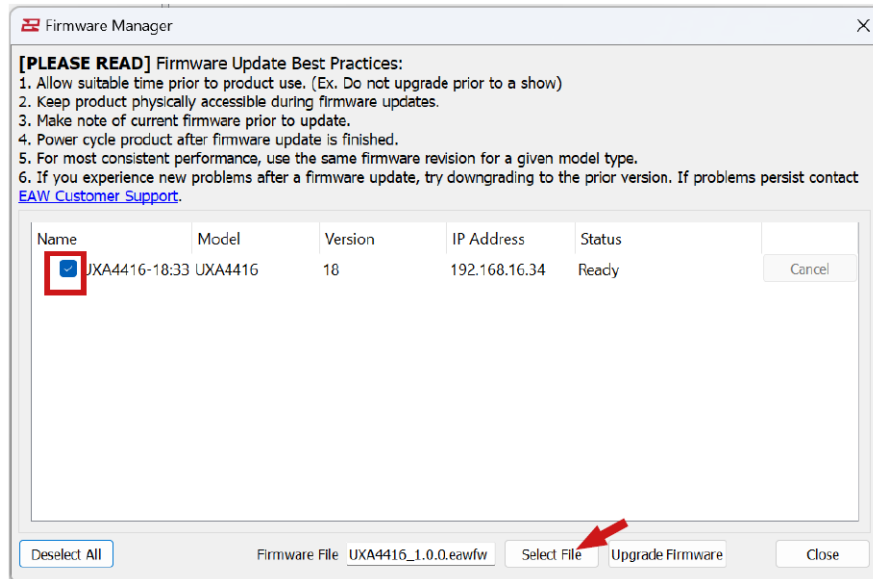

When you are ready to proceed, click **Upgrade Firmware**. Another dialog will appear asking for confirmation and will list the devices that have been selected for upgrade.

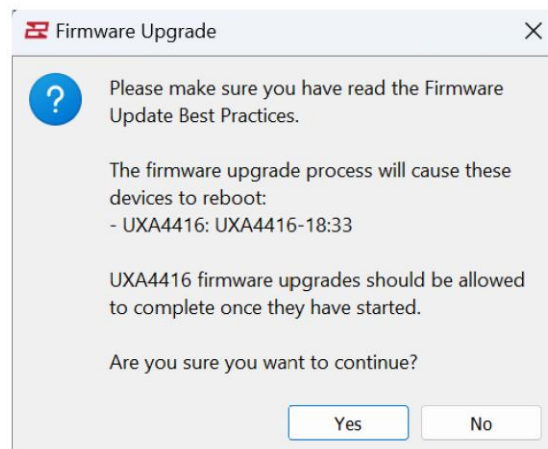

Please Read the best practices at the top of the Firmware Manager window before proceeding.

It is always best to place devices on a DHCP network. The Dante connection should be placed on the same network as the control port. It is not a good idea to loop control ports through other amplifiers as the update process can cause the network connection to stop working, interrupting the connection to devices connected on that port.

After clicking Yes, the firmware update process will lock the amplifier so it can send files uninterrupted. Once the firmware update starts it should not be stopped. The green progress bar will proceed to 100% as it uploads a number of files. After the files have been sent, the update process will complete on the amplifier.

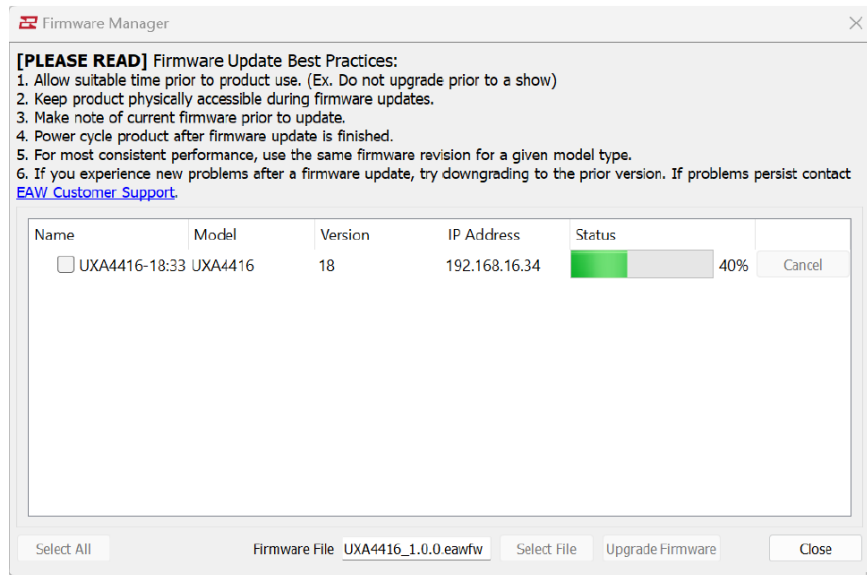

Resolution will indicate that an amplifier is being updated in the Online Devices list. It will be greyed out and show [Updating] after the name. When the update process is complete, the amplifier will return to normal in the Online Devices list and will no longer indicate [Updating].

Troubleshooting It is possible that a problem can occur during the update process. This is most likely due to some sort of network interruption. The amplifier will remain locked out. When this happens, you must restart the firmware update process by selecting the update file and amplifier and proceeding with the update.

UXA4401/UXA4403/UXA4807 Network View Processor

The Network View Processor shows an overview of the Zones and Outputs in the amplifier. Outputs that are fed by a Zone will appear beside the associated Zone.

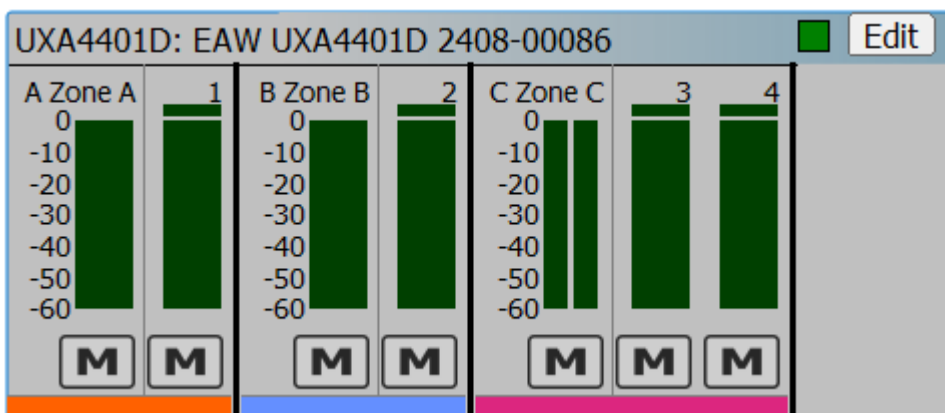

UXA4401/UXA4403/UXA4807 Processor Dialog

Main Window

The main window provides an overview of the amplifier state.

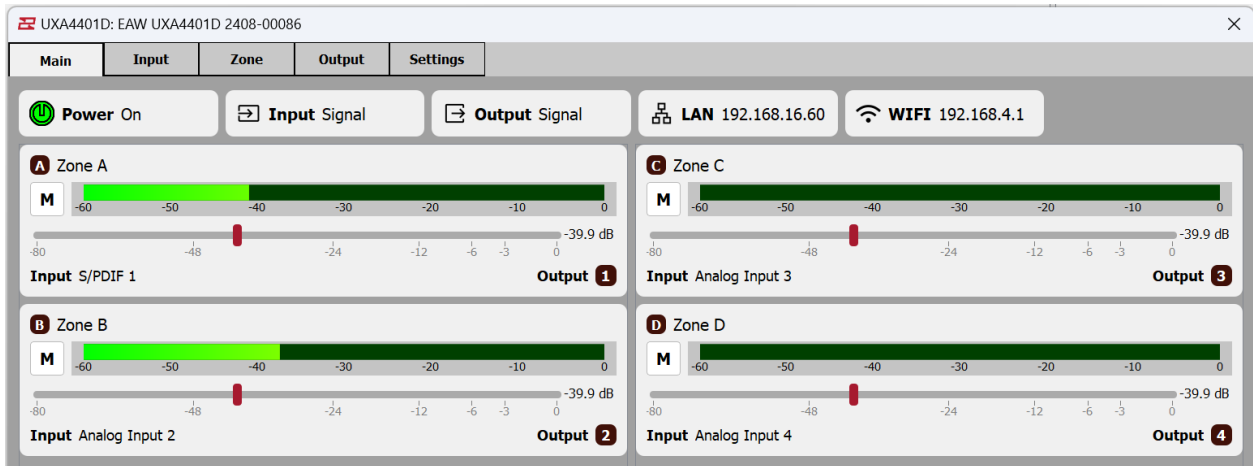

Tabs

The main sections of the amplifier can be navigated using the top-row tabs. These include the Main Overview, Input channels, Zone channels, Output channels, and amplifier Settings controls.

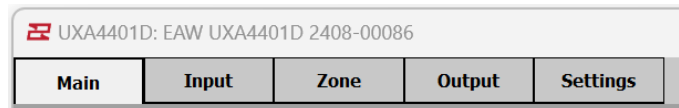

Main Overview

Status Indicators

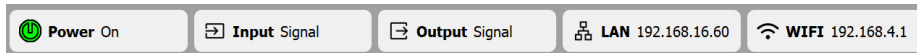

The status indicators show the current state of the amplifier.

The **Power** indicator also acts as a power button to toggle between On and Standby.

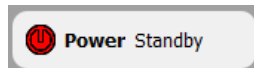

The **Input** and **Output** indicators show whether a **Signal** has been detected, on any input, or is **OFF**. If the signal is too high, then **Clip** is indicated.

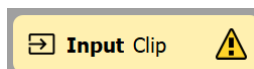

The **LAN** and **WIFI** addresses are also shown and can help indicate if the proper network connections have been made.

Zone Settings

Each Zone on the amplifier is shown in the overview. Also indicated are the input source to the zone, and the output channels that the zone feeds.

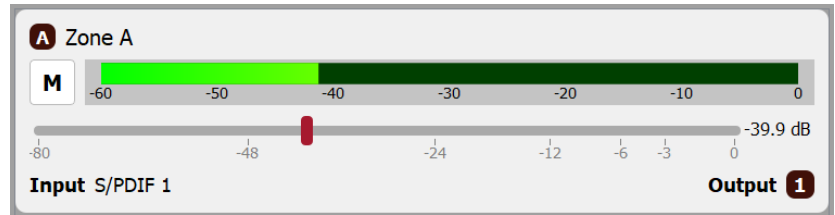

The current volume level and mute button is also shown, for direct control.

UXA4401/UXA4403/UXA4807 Input Channels Tab

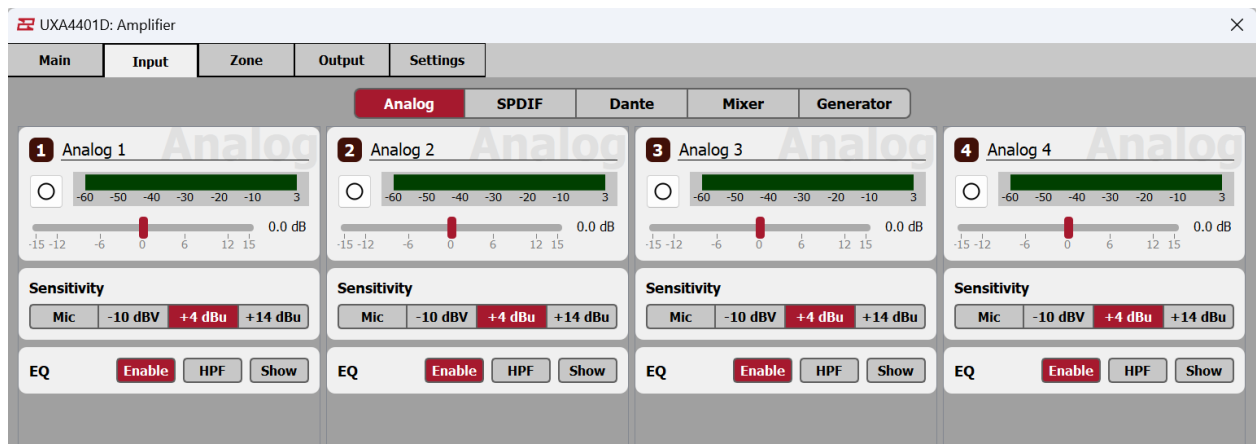

Each input has a level meter and gain control.

Stereo Input Channels

 Analog, SPDIF, and Dante inputs support stereo channels. Clicking a stereo button will combine the odd and even channels into a stereo channel, as indicated by the changed stereo button icon and the channel label "1/2".

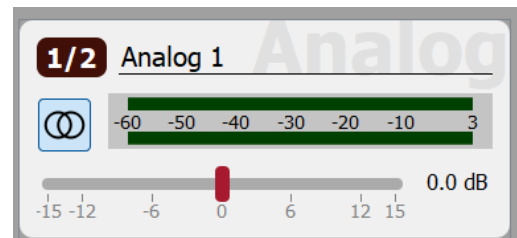

Analog Input Sensitivity

The input sensitivity can be controlled using the following buttons illustrated on the right.



Analog Input Equalization

Each analog input has a 5 band equalizer. The type of each band can be changed to PEQ, High/Low pass, or High/Low shelf. In addition, there is a fixed 100Hz High Pass filter that may be toggled on or off.

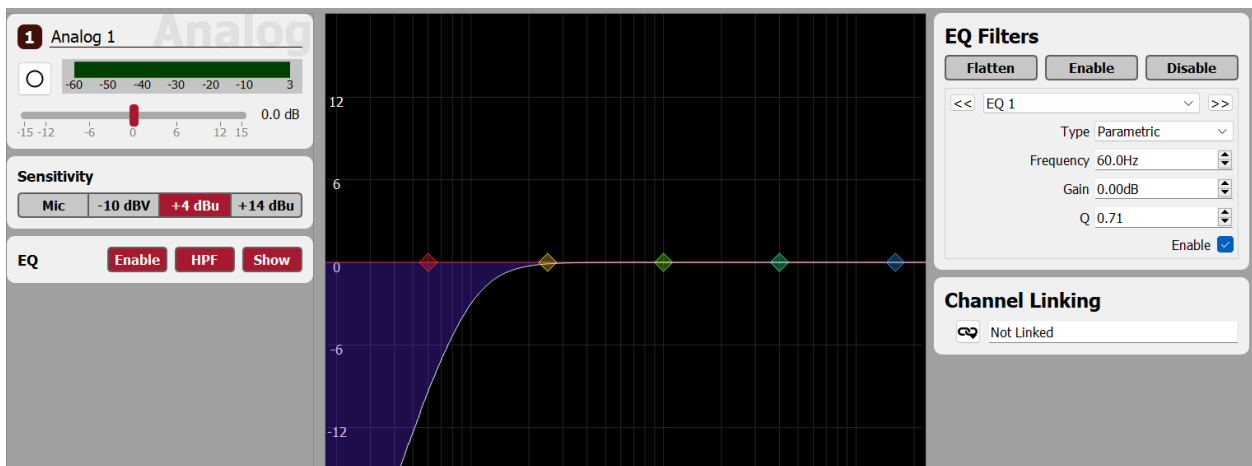

EQ Filters

Each EQ point can be controlled in EQ Filters. Select the EQ filter to control. EQ input has 5 filters.

Global control buttons across the top affect all filters. **Flatten** will reset all filters to their default values. **Enable** and **Disable** will toggle each EQ filter to that state.

The **Type** of each EQ point can be changed to Parametric, High or Low pass, Shelf, Band Pass, Notch, or All pass filter. The appropriate controls for the type will appear when the type is changed.

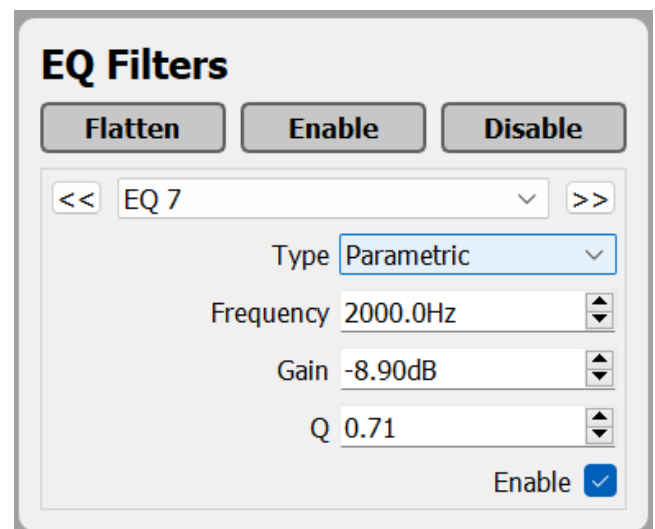

Channel Linking

Channel linking supports grouping channels that share a subset of EQ settings. Any adjustments made to a shared EQ control on one channel will be propagated to all channels in the group.

New groups can be created. The first channel added to the group will define the initial EQ settings.

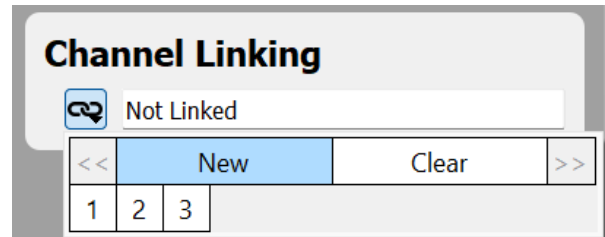

A channel can be added to a group by selecting the group number in the drop down box. Any channel added to a group will have its EQ settings overwritten by the settings in the group.

A channel can be removed from a group by selecting "Clear". Channels removed from a group retain the EQ settings made to that point but will no longer synchronize adjustments with any other channel.

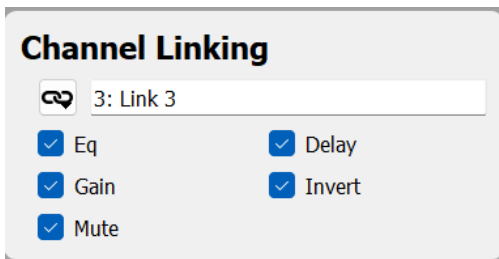

Linked controls, within a group include Eq, Gain, Mute, Delay, and Polarity (Invert). Only those controls showing a checkmark will be copied between group members.

Linked channels are indicated as such with the group number placed in the upper right corner of the equalizer view for the channel.

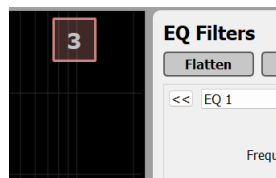

The group number is also shown along with the channel equalizer controls.

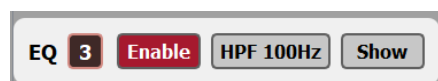

If the Analog Input is a source for any Zone, then the channel link group number will be shown on the corresponding Zone on the processor object in Network View.

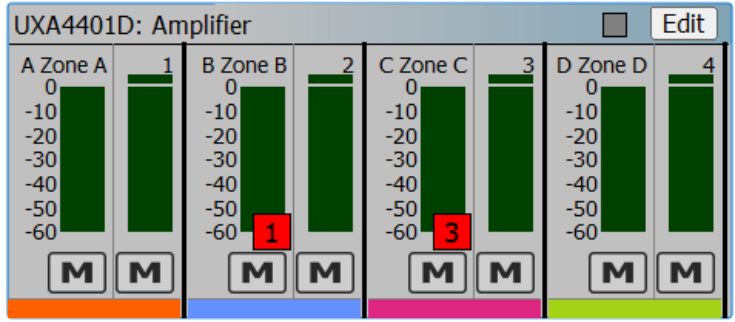

Mixer

The mixer input channel supports mixing Analog, SPDIF, and Dante inputs into a single mixed input.

Each input channel has a gain control and meters.

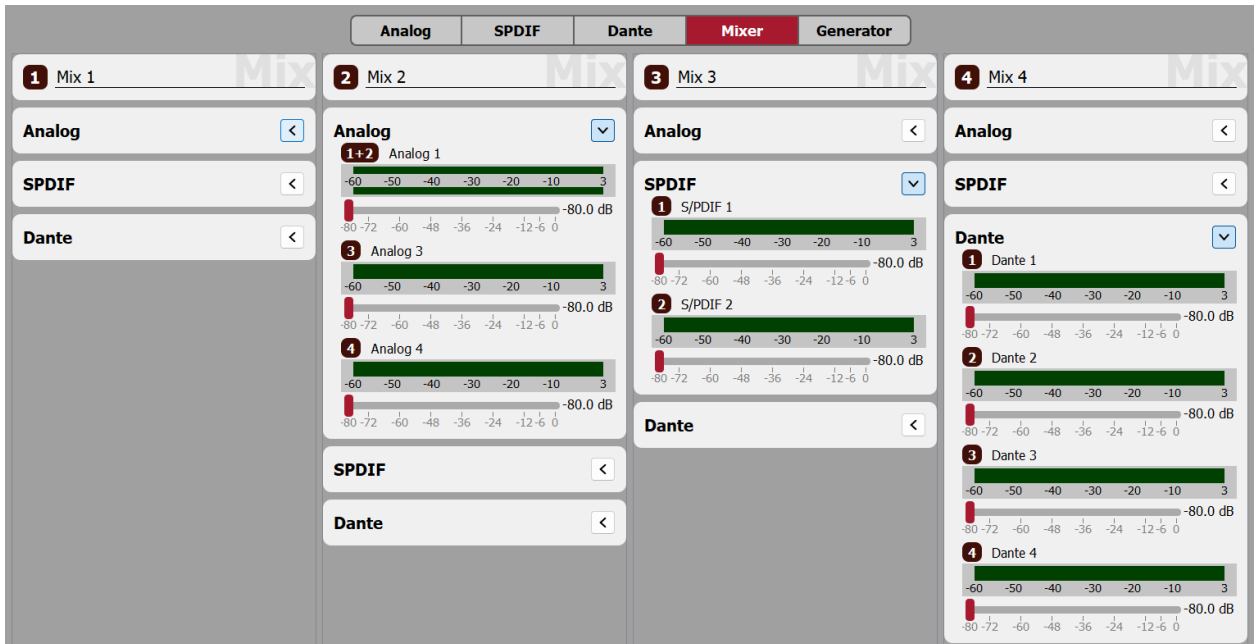

Generator

The Generator input provides Sine Wave and Pink Noise signals as input sources.

The volume limit of the generator can be set from -48dB to 0dB.

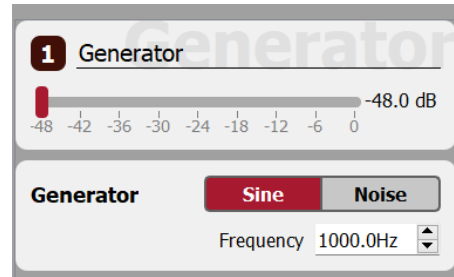

The Frequency of the **Sine** wave input can be set from 20Hz to 20kHz.

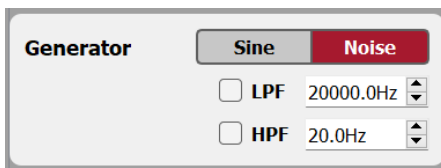

The **Noise** signal can be filtered between high and low frequency limits using the High Pass and Low Pass filter controls.

UXA4401/UXA4403/UXA4807 Zone Channels Tab

Zones provide input control for outputs. Each zone has a primary input source and a priority source. The priority source can be set to automatically override the primary source, based on signal detection, for important announcements or emergencies.

Zones support Stereo channels, volume level, and mute. Value can be controlled using the volume slider or GPIO control connected to the back of the amplifier. When a Zone's volume level is controlled by a GPIO connection, the volume slider will be disabled and will show which GPIO pin is being used for control.

Source Tab

The source tab is used to select the input channel feeding the zone as the Primary Input.

A **Priority Input** channel can also be specified as an alternate for such events as announcements.

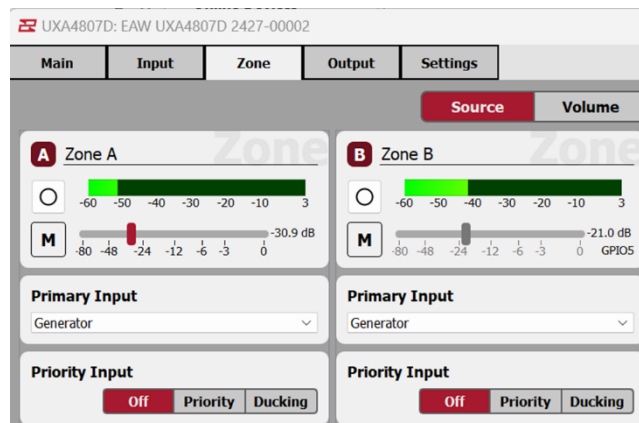

Zone Primary Source

The main input source can be selected from the Primary Input drop down menu. The channels listed in this box are filtered by the Zone Restrictions settings made in the Restrictions tab. Stereo channels are indicated as such. Primary sources are filtered by the selections made in the Zone Restrictions tab.

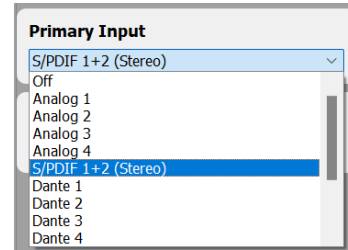

Priority Input

The priority input selection defines an alternate input source used to interrupt the current signal when announcements or emergency signals need to be made. There are two modes for signal detection.

Priority Mode

Priority mode is used to interrupt the primary source signal when a minimum Threshold level is detected on the priority input. In Default, only the threshold needs to be specified. In Manual mode, basic compressor settings are provided for detecting the signal within the specified timeframe. Attack is the time at which the signal must exceed the threshold for the Priority signal to override. Release is the amount of time after the signal falls below the threshold in order to switch back to the Primary input.

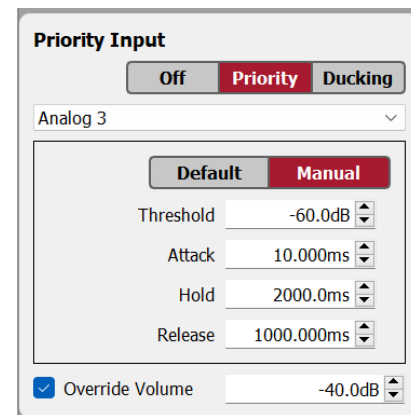

Hold is the amount of time that the signal must fall outside of the threshold for the Attack or Release to trigger. It is not desirable to hear the priority signal toggling on and off when its level is close to the threshold value, so the Hold time could allow the attack to briefly fall below the threshold without switching the priority signal off.

Override Volume is used to specify a different volume level for the Priority input than the Zone volume level for the Priority input.

Ducking Mode

Ducking differs from Priority mode in that the Primary signal is not cut but can be reduced in level so that the Priority input can be heard.

The usual compressor settings are available for signal detection. A Depth control is added to attenuate the Primary source signal when the Priority signal is mixed in.

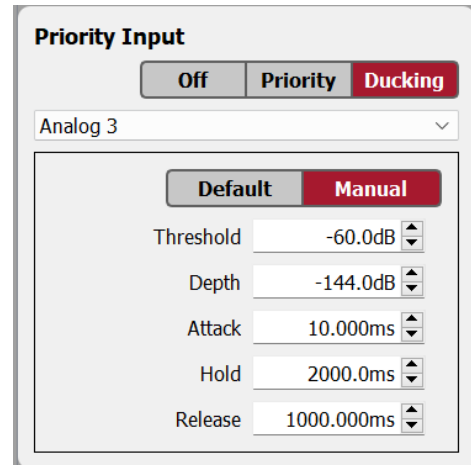

Zone Volume Tab

The Zone Volume controls are used to configure the range and external control of the Zone volume.

“Volume Range” can be set to minimum and maximum values. Doing so will prevent the gain control from being adjusted beyond these limits.

“Allow Mute” control can be used to prevent the Mute button from operating.

“Volume Control on GPIO” allows users to set the GPIO pin to be used for controlling volume. Individual pins must be enabled prior to use. See the GPIO settings page on the Settings tab.

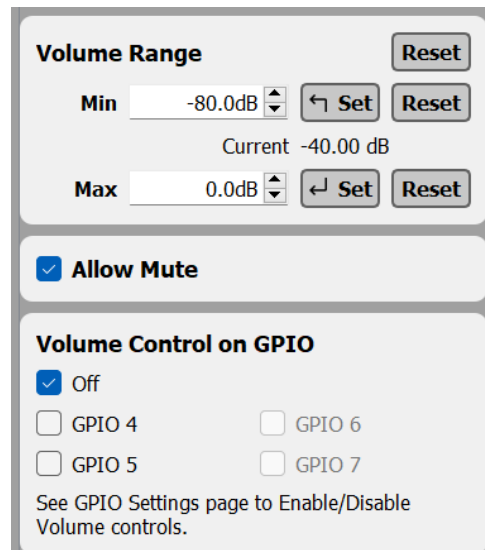

Zone Restrictions Tab

Zone Restrictions permit users to set the inputs that can be selected as a Primary source.

Inputs are presented in a grid where green check marks indicate that the input source is allowed to be selected as a Primary input to the current Zone. A red X mark indicates that the input is not selectable as an input source. Only those inputs with a green check mark will appear in the Primary Source input selection on the Zone Source tab.

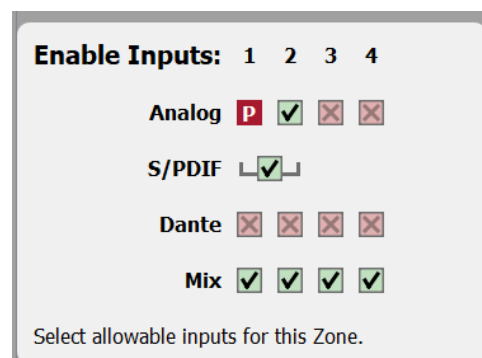



A red P symbol indicates the input is already selected as the Primary source. It cannot be deselected.



Stereo inputs are indicated with range lines to show that the checkmark controls two input channels.

Zone Compressor Tab

Each Zone channel has a compressor that can be enabled or disabled.

Default settings include Threshold control.

Attack is the time that the signal must exceed the Threshold for the compressor to engage.

Release is the time that the signal must fall below the Threshold for the compressor to disengage.

Hold is the amount of time that the Attack or Release time must be detected before they take effect.

The Ratio is used to determine the amount of volume reduction the compressor will apply above the threshold. For example, a Ratio of 3 indicates that for every 3dB rise in signal volume at the compressor input, the signal will only rise 1dB in level. So, if the signal rises to 12dB above the threshold, then the compressor output will be at the threshold level plus $12\text{dB} / 3 = 3\text{dB}$.

The Knee value is used to smooth out the transition between compression and non-compression across the Threshold. The transition can be smoothed by increasing the Knee. The compressor will begin to apply compression gradually as it approaches the threshold, based on where the Knee is set.

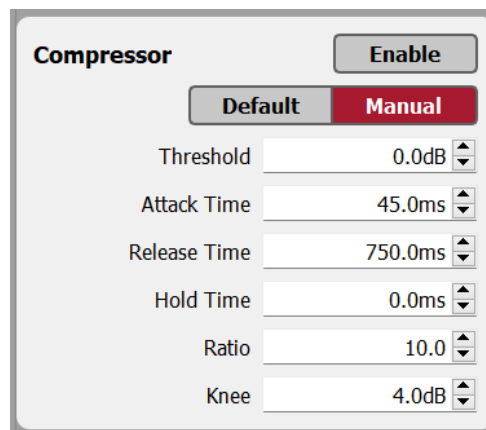

UXA4401/UXA4403/UXA4807 Output Tab

The Output channel controls include volume and mute. Speaker presets, tailored to a specific speaker model, can be applied to the channel. Zones provide the input source to an Output channel. Each output has equalization and delay.

Speaker Preset

EAW Greybox presets provide optimized settings for EAW loudspeakers. Each amplifier can store a library of speaker presets. Resolution comes with a list of the most recent preset revisions.

Greybox presets can be selected from the drop-down list. Preset names ending with "***" are defined on the amplifier and not in Resolution. This does not prevent them from being selected when connected to the amplifier, but they will not be available as a selection when the amplifier is offline.

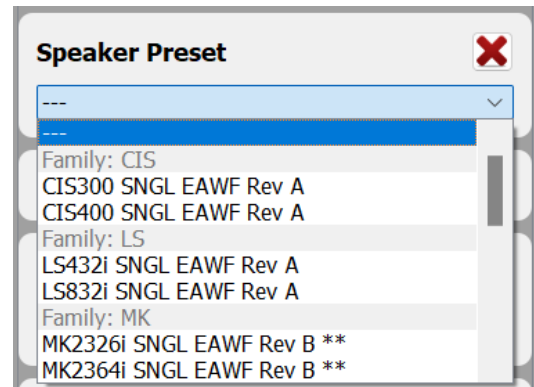

Routing (Output Source)

The Routing section defines the Zone input source to the output channel.

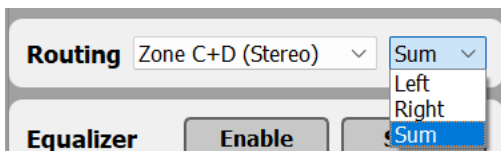
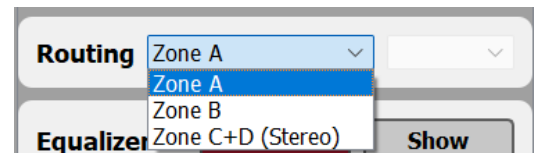

If the selected Zone source is a stereo input, then a the stereo channel must be chosen as the input to the Zone, or a sum of the left and right channels.

Output Equalizer

The output equalizer can be enabled or disabled on the output channel. Polarity of the channel can be toggled on or off.

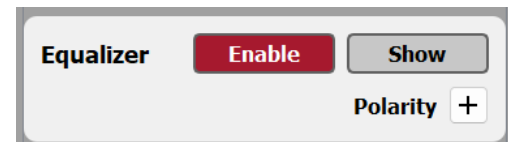

The output equalizer operates the same way as the Analog Input equalizer with some small differences. The output equalizer has 10 EQ points instead of 5, and includes additional Shelf filters, Band and Notch filters, and All Pass filters.

Channel Linking

Channel Linking works the same way as input channel linking. However, output channels cannot be included in the same group as input channels.

Delay

The output delay can be adjusted to 100ms. It can also be turned off by utilizing the checkbox.

There are several units available for specifying the delay in terms of time or distance. The sample rate is based on 48kHz.

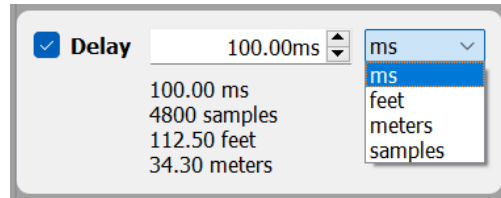

UXA4401/UXA4403/UXA4807 Settings Tab

Device Information

This section provides information about the device, such as manufacturer, model, and serial number, that cannot be edited.

There is a Find Me button that will force lights on the front panel to blink so that the settings can be visually associated with a physical amplifier. The Update button will open the Firmware Update dialog.

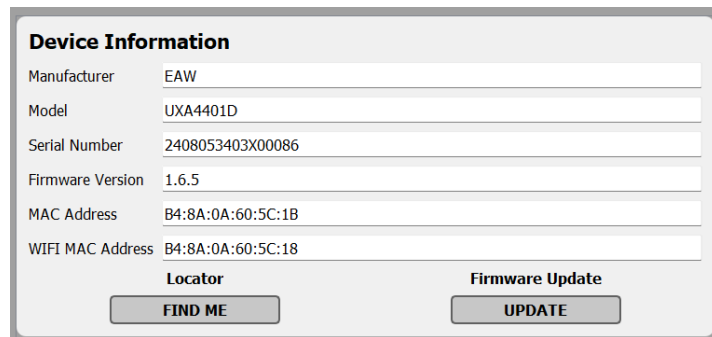

System Information

System Information provides user editable information about the amplifier along with installation notes with a limit of 512 characters.

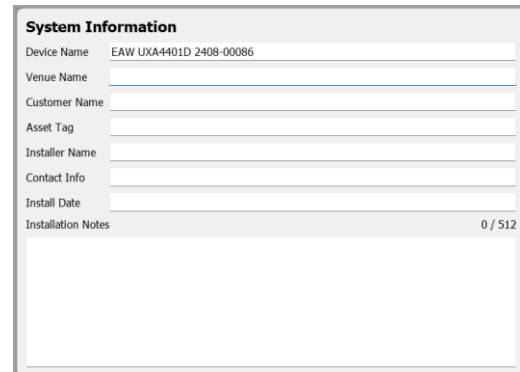

Dante Information

This section provides non-editable information about the Dante card in the amplifier if the amplifier has a Dante card.

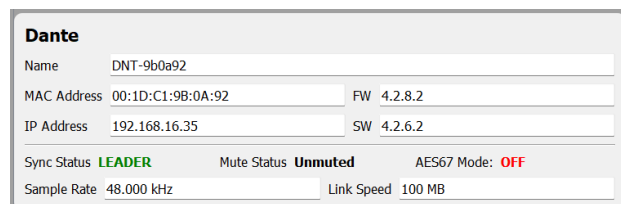

Password Protection

A password can be set on the amplifier that governs access to the amplifier through the web interface. Resolution does not observe the password control and will not prevent access to an amplifier.

Select Enabled to turn password protection on. Enter a password in the Password box and repeat it in the second box. They must match to Apply the change.

Password Protection Enabled Disabled

Password

Repeat

✓ Matching Apply

To see the passwords entered, during this process, click the eye button. (The use of “password” as a password is for illustrative purposes only.)

If the passwords match, then the Apply button lights up green. Clicking this button will send the new password to the amplifier. Applying a new password does not logout anyone using the web interface at the time of the change.

Settings GPIO Tab

The GPIO settings are used to specify what each GPIO pin is used for. For Zone Volume control, setting a GPIO, such as Pin 4, will allow that pin to be selected as the volume control on any Zone channel.

Information **GPIO** **Routing** **Network** **Power** **Library**

PIN 1
Soft Ground
Use for 12V trigger and standby/mute input reference.

PIN 2
 Off
Pin has no functionality (Default).
 Standby NO
Amplifier will enter standby when Pin 2 is connected to GND.
 Standby NC
Amplifier will enter standby when Pin 2 is unconnected (floating).
 Mute NO
All amplifier outputs are muted when Pin 2 is connected to GND.
 Mute NC
All amplifier outputs are muted when Pin 2 is unconnected (floating).

PIN 3
Ground
Use as reference for Volume Control and Trigger Out.

PIN 4
 Volume Control
When selected the pin is used for external volume control (Default).
 Off
Pin has no functionality.

PIN 5
 Volume Control
When selected the pin is used for external volume control (Default).
 Off
Pin has no functionality.

PIN 6
 Trigger 12V In
Amplifier will operate when 12V signal is applied to Pin 6 - will enter standby when no signal applied. Requires Trigger-Mode selected in Power-Mode Section (Default).
 Volume Control
When selected the pin is used for external volume control.
 Off
Pin has no functionality.

PIN 7
 Trigger 12V Out
12V Output Trigger (Default).
 Volume Control
When selected the pin is used for external volume control.
 Off
Pin has no functionality.

PIN 8
Power 3.3V
3.3V Power for Volume Controls.

Output Routing Tab

Output routing is used to route input audio signals directly to S/PDIF or Dante outputs. The gain of the output signal can be controlled.

The screenshot shows the 'Routing' tab of a software interface. It is divided into two main sections: 'S/PDIF Outputs' and 'Dante Outputs'. Each section contains two rows of controls. Each row includes a dropdown menu (set to 'Off'), a green level meter with a scale from -60 to 3, and a gain slider with a scale from -40 to 20 dB. The 'S/PDIF Outputs' section is on the left, and the 'Dante Outputs' section is on the right. The interface also has a top navigation bar with tabs for 'Information', 'GPIO', 'Routing', 'Network', 'Power', and 'Library'.

Network Settings Tab

The WIFI settings control connection through the WIFI

The screenshot shows the 'WIFI' settings tab. It features a 'WIFI' section with a checked 'ENABLE WIFI' option. Below this is a note: 'When WIFI is disabled the only way to connect to the amplifier is using the LAN port. The settings can be reset by pressing the Factory Reset button during startup or connecting via LAN and enabling WIFI again.' There are two buttons: 'Do Nothing' (highlighted in red) and 'Disable WIFI'. The 'Disable WIFI After' section has four buttons: '5 min', '10 min', '30 min', and 'Always On' (highlighted in red). A note states: 'If set to any other value than "Always On," WIFI will be turned off after the selected duration. Amplifier will need power cycling to turn WIFI on again.' The 'WIFI Mode' section has two buttons: 'Access Point' (highlighted in red) and 'Client'. At the bottom, there are input fields for 'Name (SSID)' with the value 'EAW UX4401D 2408-00086' and 'Password' with the value 'password'.

Under LAN Settings the amplifier can be configured to have a DHCP or Static IP address. Changes must be applied to take effect.

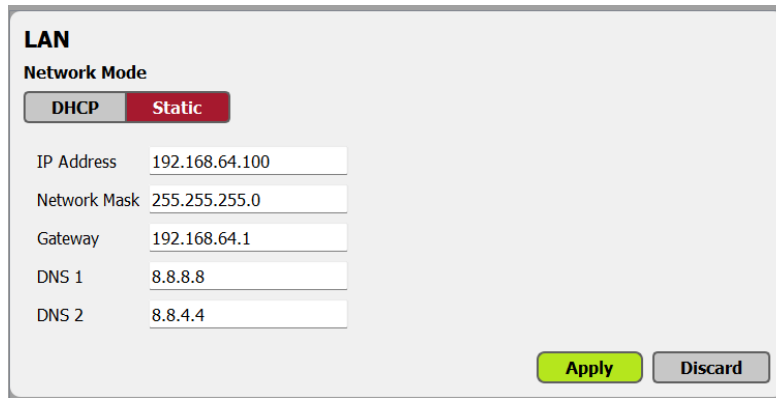

The image shows a 'LAN' settings dialog box. At the top, it is titled 'LAN' and 'Network Mode'. There are two buttons: 'DHCP' and 'Static', with 'Static' being the active selection. Below this, there are several input fields: 'IP Address' (192.168.64.100), 'Network Mask' (255.255.255.0), 'Gateway' (192.168.64.1), 'DNS 1' (8.8.8.8), and 'DNS 2' (8.8.4.4). At the bottom right, there are two buttons: 'Apply' (highlighted in green) and 'Discard'.

Settings Power Tab

Power usage can be configured on the Power tab. Several of the choices can result in the amp entering standby when an audio input signal has not been detected for a length of time defined by the **Standby Time** control.

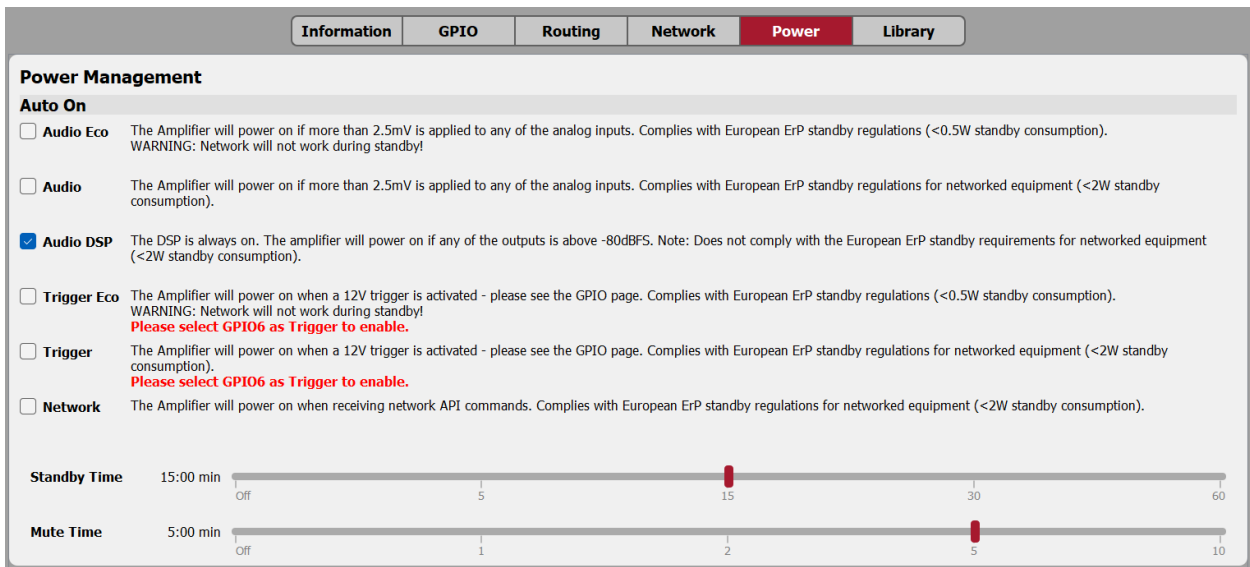

The image shows the 'Power Management' settings screen. At the top, there are tabs: 'Information', 'GPIO', 'Routing', 'Network', 'Power' (active), and 'Library'. The main content area is titled 'Power Management' and 'Auto On'. It contains several options with checkboxes and descriptions:

- Audio Eco** The Amplifier will power on if more than 2.5mV is applied to any of the analog inputs. Complies with European ErP standby regulations (<0.5W standby consumption). WARNING: Network will not work during standby!
- Audio** The Amplifier will power on if more than 2.5mV is applied to any of the analog inputs. Complies with European ErP standby regulations for networked equipment (<2W standby consumption).
- Audio DSP** The DSP is always on. The amplifier will power on if any of the outputs is above -80dBFS. Note: Does not comply with the European ErP standby requirements for networked equipment (<2W standby consumption).
- Trigger Eco** The Amplifier will power on when a 12V trigger is activated - please see the GPIO page. Complies with European ErP standby regulations (<0.5W standby consumption). WARNING: Network will not work during standby! **Please select GPIO6 as Trigger to enable.**
- Trigger** The Amplifier will power on when a 12V trigger is activated - please see the GPIO page. Complies with European ErP standby regulations for networked equipment (<2W standby consumption). **Please select GPIO6 as Trigger to enable.**
- Network** The Amplifier will power on when receiving network API commands. Complies with European ErP standby regulations for networked equipment (<2W standby consumption).

Below the options, there are two sliders:

- Standby Time**: 15:00 min. The slider is set to 15 minutes. The scale ranges from Off to 60 minutes.
- Mute Time**: 5:00 min. The slider is set to 5 minutes. The scale ranges from Off to 10 minutes.

Preset Library Tab

This tab is useful for viewing differences between the preset library in Resolution and the library on the amplifier. Presets that are not available in both places are indicated by orange shading.

The current library in Resolution can be sent to the amplifier using the **Send** button. Sending a preset library to the amplifier will overwrite its current library.

The screenshot shows a software interface with a top navigation bar containing tabs: Information, GPIO, Routing, Network, Power, and Library (highlighted in red). Below the navigation bar is the "Speaker Library" section. A note states: "Note: A speaker preset, in the Resolution library, can be selected as the current preset on an output channel from the Output page. Doing so will send the preset to the amplifier but will not add it to the amplifier library." The interface is split into two columns: "Resolution Preset Library" and "Amplifier Preset Library".

Resolution Preset Library
Name: EAW UXA4401 Speaker Library | Version: 2.2

- ✓ CIS
 - CIS300 SINGL EAWF Rev A
 - CIS400 SINGL EAWF Rev A
- ✓ LS
 - LS432i SINGL EAWF Rev A
 - LS832i SINGL EAWF Rev A
- ✓ MKC
 - MKC50 SINGL EAWF Rev B
 - MKC60 SINGL EAWF Rev B
 - MKC80 SINGL EAWF Rev C
- ✓ MKD
 - MKD526 SINGL Rev A

Amplifier Preset Library
Name: EAW UXA4401 Speaker Library | Version: 2.1

- ✓ CIS
 - CIS300 SINGL EAWF Rev A
 - CIS400 SINGL EAWF Rev A
- ✓ LS
 - LS432i SINGL EAWF Rev A
 - LS832i SINGL EAWF Rev A
- ✓ MK
 - MK2326i SINGL EAWF Rev B
 - MK2364i SINGL EAWF Rev B
 - MK2366i SINGL EAWF Rev B
 - MK2394i SINGL EAWF Rev B
 - MK2396i SINGL EAWF Rev B
 - MK2399i SINGL EAWF Rev B
 - MK5326i SINGL EAWF Rev B
 - MK5364i SINGL EAWF Rev B
 - MK5366i SINGL EAWF Rev B
 - MK5394i SINGL EAWF Rev C
 - MK5399i SINGL EAWF Rev C
 - MK8126i SINGL EAWF Rev C
 - MK8196i SINGL EAWF Rev C
- ✓ MKC
 - MKC50 SINGL EAWF Rev B

A "Send" button is located at the bottom center of the interface.

UX48, UX4406, UX4410, UX4810 Input Section

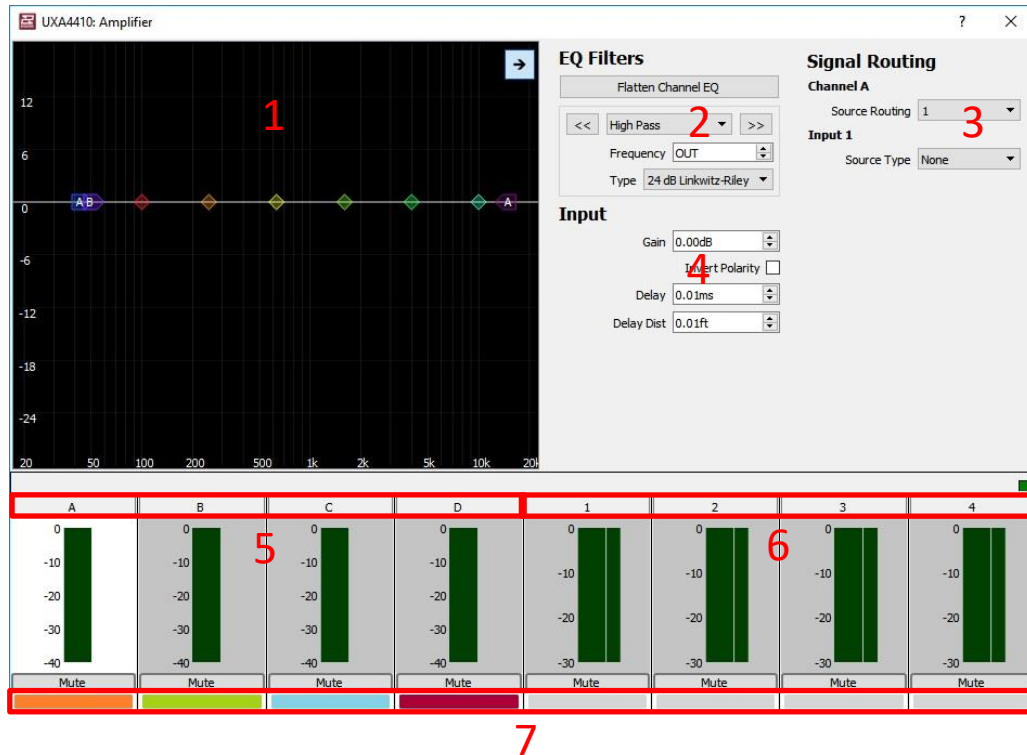

- 1. EQ/Filter Graphic Window:** Click and drag functionality to control Low Shelf Filters, (5) PEQ Filters, and an FIR Hi Shelf Filter. Clicking the right facing arrow at the top corner expands and hides the detail pane.
- 2. EQ/Filters Section:** Manually adjust settings for all Filters. Use << >> buttons to navigate from one band to the next. There is an additional pull-down menu to choose type of filter, with an option to disable the FIR High Shelf to reduce latency (this filter is disabled by default).
- 3. Signal Routing:** Assign input sources to input channels, or combine input sources to a single input channel. Select an input source type between Analog, AES3, and Dante (See both pull-down menus below).

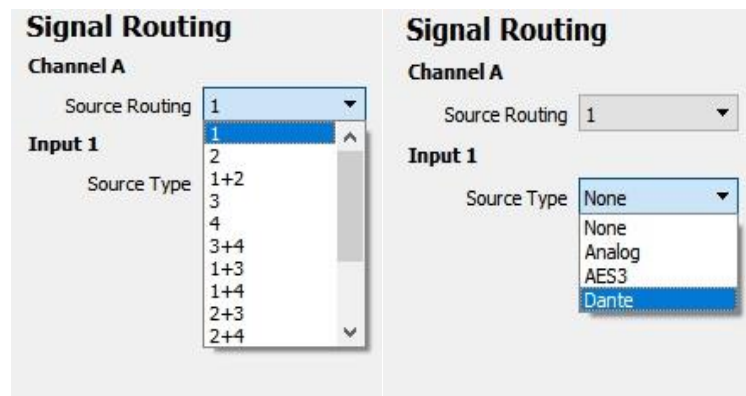

4. **Input Section:** Adjust gain, invert polarity, and set delay or delay distance.
5. **Input Channels:** Signal meters and channel labels. To change a channel label, double click on the default letter/number and type in a friendly name.
6. **Output Channels:** Signal meters and channel labels. To change a channel label, double click on the default letter/number and type in a friendly name.
7. **Input/Output Color Indicators:** An easy method to distinguish which outputs are utilizing which input source (Assigned output channels will match the color of input channels).

UX48, UX4406, UX4410, UX4810 Output Section

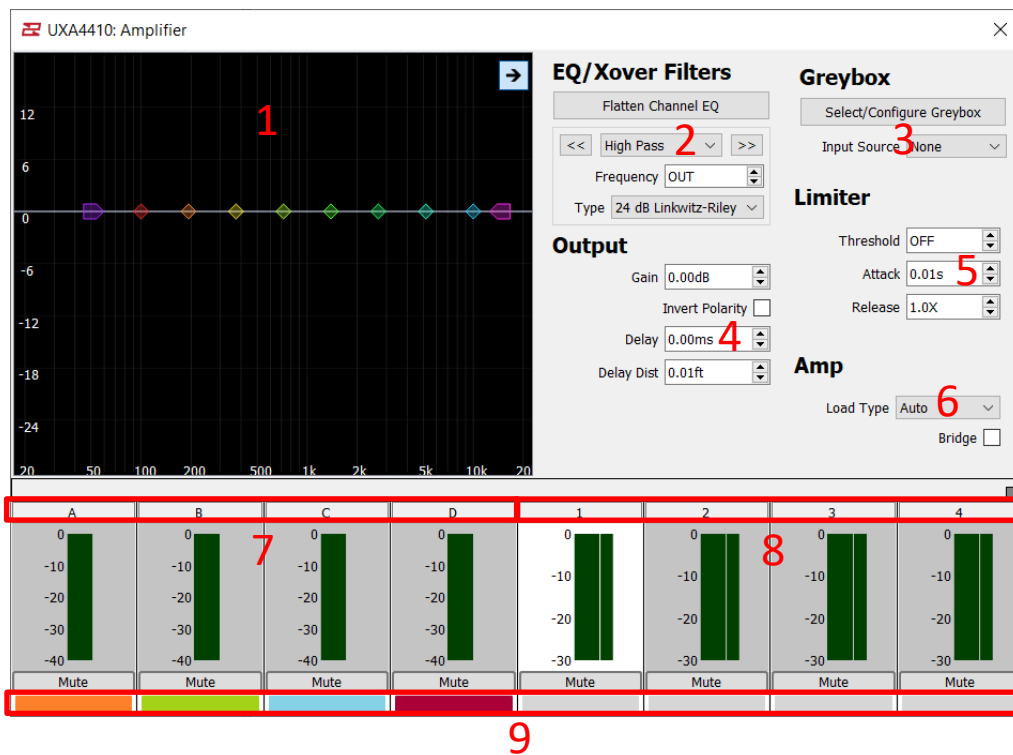

1. **EQ/Filter Graphic Window:** Click and drag functionality to control a Low/High Pass Filters, Low/High Shelf EQs, and (6) PEQ Filters. Clicking the right facing arrow at the top corner expands and hides the detail pane. Once a Greybox is loaded, only the HPF may be modified.
2. **EQ/Filters Section:** Manually adjust settings for all EQ/Filter bands. Use << >> buttons to navigate from one band to the next. There is an additional pull-down menu to choose type of filter. Once a Greybox is loaded, only the HPF may be modified.

- Greybox:** Load EAW Greyboxes and set Input source (*See pull down menu below*).

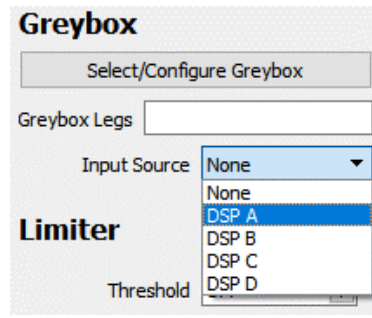

- Output Section:** Adjust gain, invert polarity, and set delay or delay distance. Unity Gain and Invert Polarity is disabled once a Greybox is loaded.
- Limiter:** Set Voltage Threshold, as well as Attack and Release times.
- Amp:** Bridge amplifier output channels and select the load type in either voltage or ohms (an *auto* option is also available).
- Input Channels:** Signal meters and channel labels. To change a channel label, double click on the default letter/number and type in a friendly name.
- Output Channels:** Signal meters and channel labels. To change a channel label, double click on the default letter/number and type in a friendly name.
- Input/Output Color Indicators:** An easy method to distinguish which outputs are utilizing which input source (Assigned output channels will match the color of input channels).

Loading Greyboxes for UX48, UX4406, UX4410, UX4810

To load a Greybox onto one of the UX/UXA devices, click the **Edit** button to open the edit window.

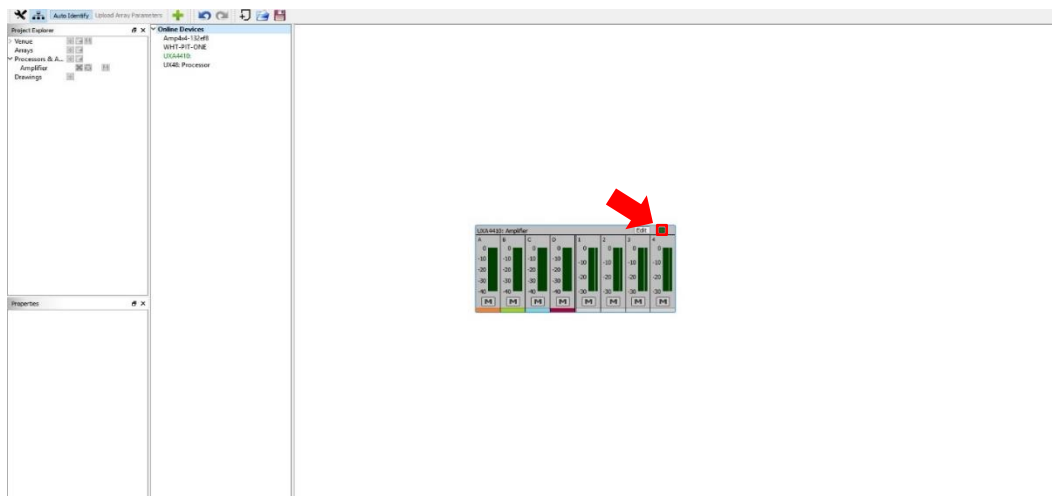

Click any output channel, then click on **Select/Configure Greybox**.

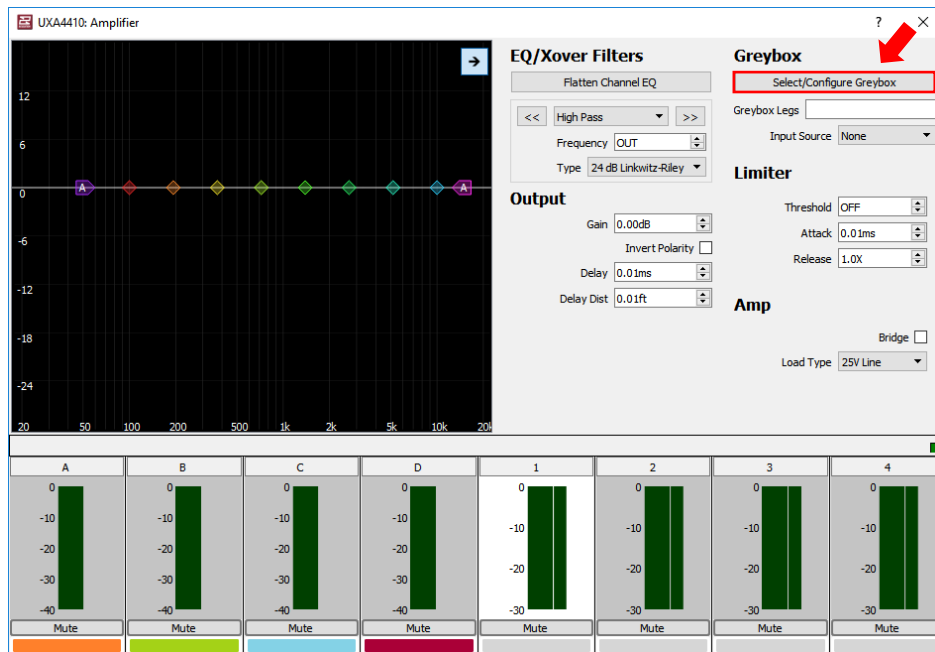

On the main Greybox Configuration window, click **Add Greybox...**

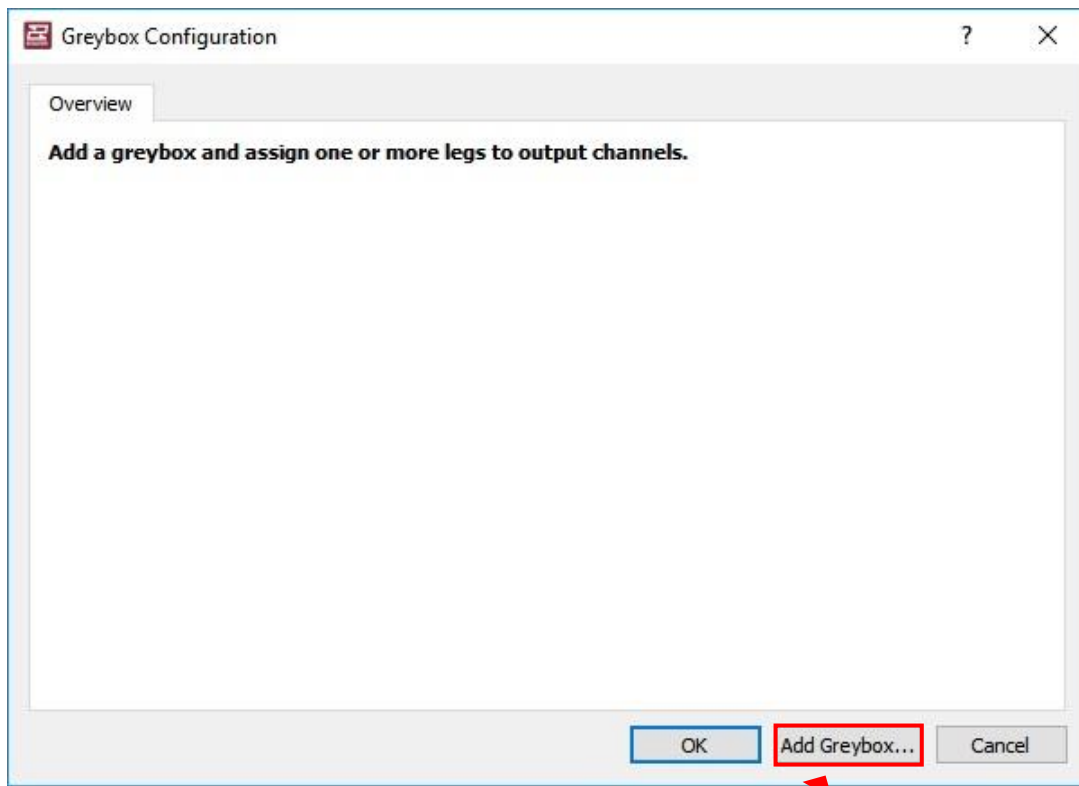

In the Greybox Picker window, choose the Series, Model, and exact Greybox configuration of the Loudspeaker. Click “OK” to proceed.

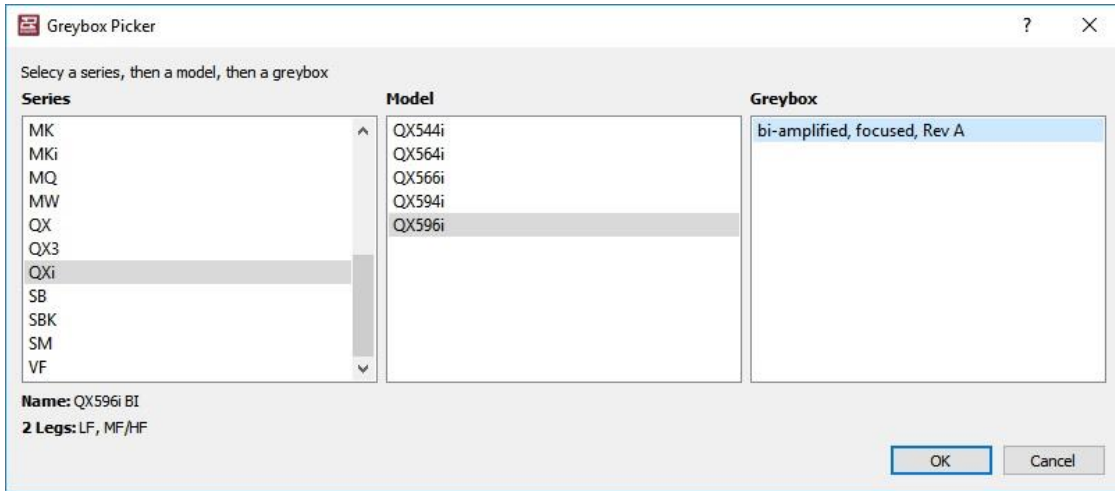

The Greybox Configuration window should now be populated with set up options. Here, assign an input, an output channel for each Leg, and Listener Distance. Click “OK” once complete.

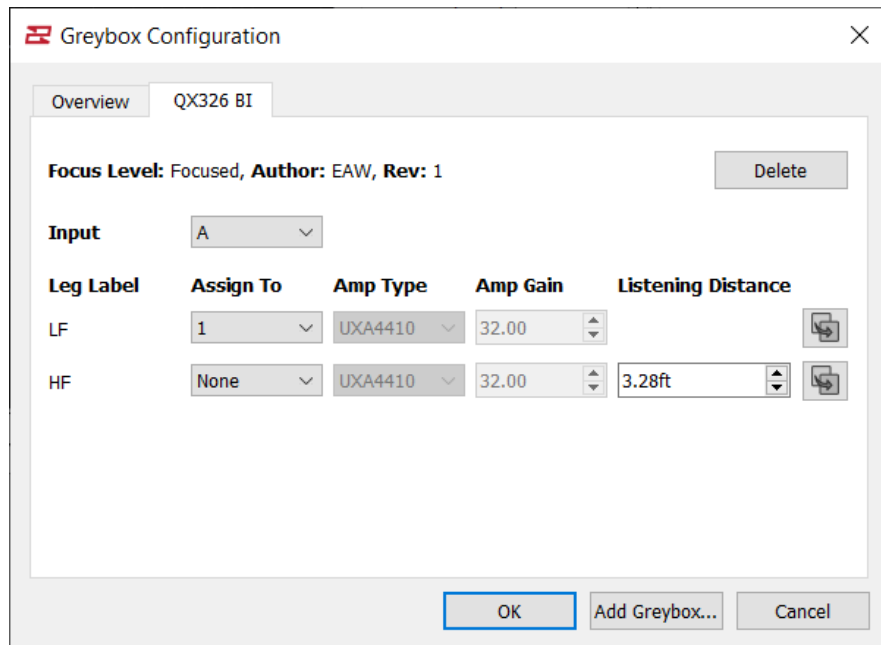

The Greybox is now loaded, as shown below in the Edit Window. **NOTE:** The output channels should be color coded to match the assigned input channel (i.e. orange in this example).

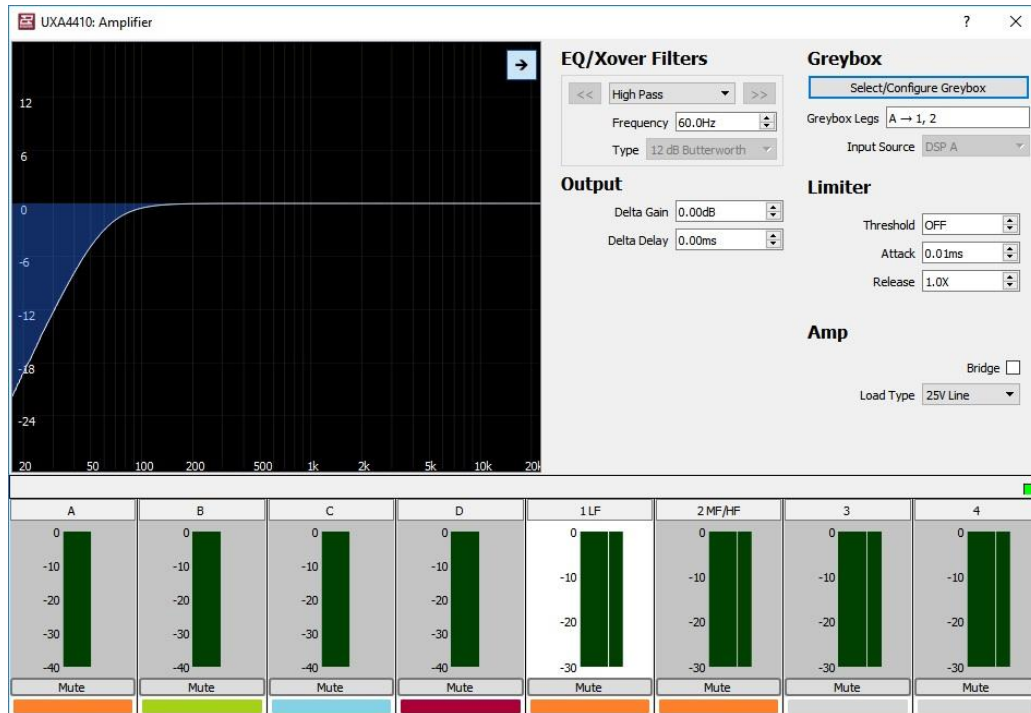

Unify Processor Interfaces

CRITICAL SETUP NOTE:

It is necessary to “teach” each amplifier which Dante card is installed internally. If more than one Processor and Dante Interface is seen in the list, it is suggested to turn off all amplifiers except one. Refresh the network, then Unify the processor to the Dante card. Repeat this for each amplifier. This will ensure that you are connecting the correct Amplifier Processor to the Correct Dante Card in that amplifier.

This will not be necessary in a future firmware build, but for now it is highly suggest doing this step to ensure network control stability

This function is to assist in determining the network address of the primary and secondary Dante card when Resolution is connected to the Ethernet port of a UX processor or UXA amplifier. The IP address of the Dante card is stored in the internal memory. This is only required once unless the internal Dante card is replaced.

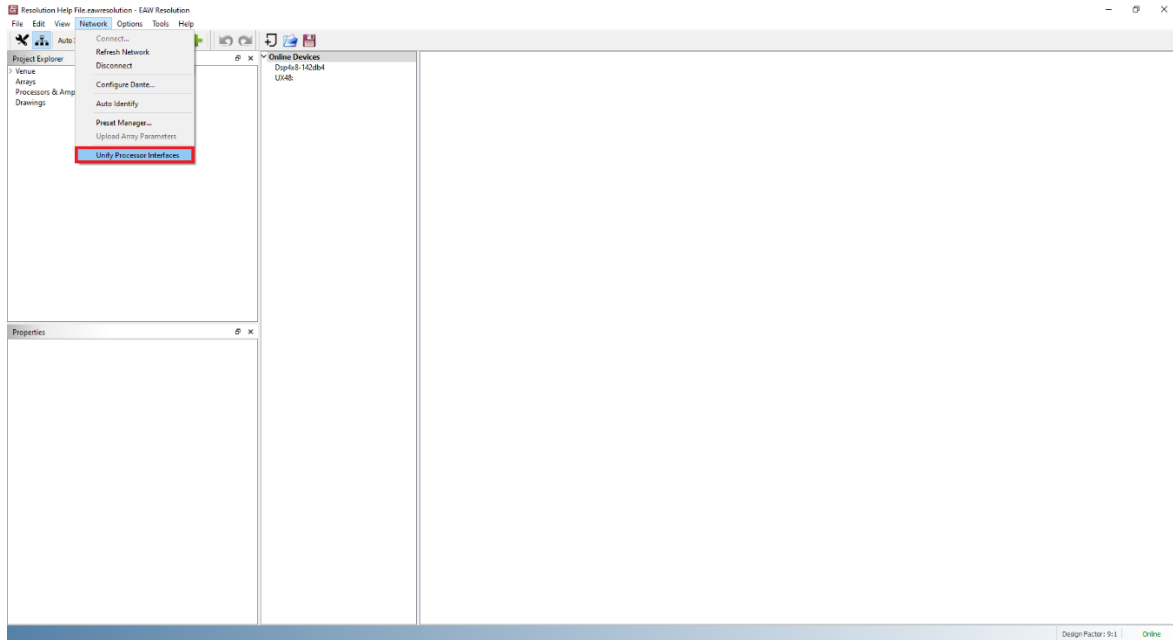

Resolution needs to know the Dante address so routing can be done between devices in Resolution. *NOTE: Processor or Amplifier control will work fine without a unified Dante port.*

With the Unify Processors window open, select the processor and Dante interface that needs to connect. Click Unify to complete.

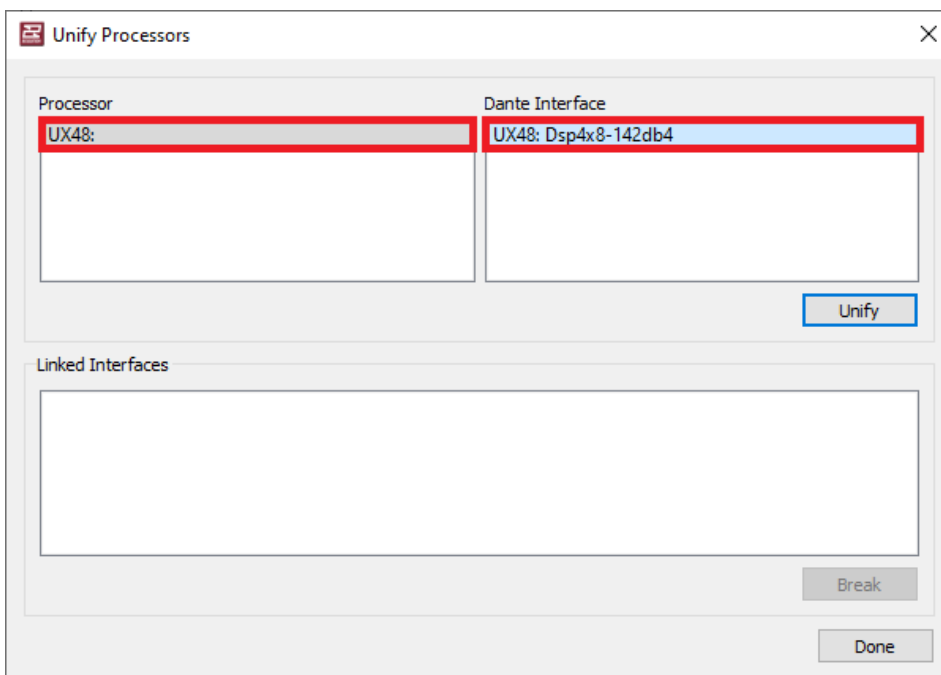

After the function is complete, the linked interface may be viewed in the bottom pane as illustrated below. Click Done to accept or Break to undo and reverse the action.

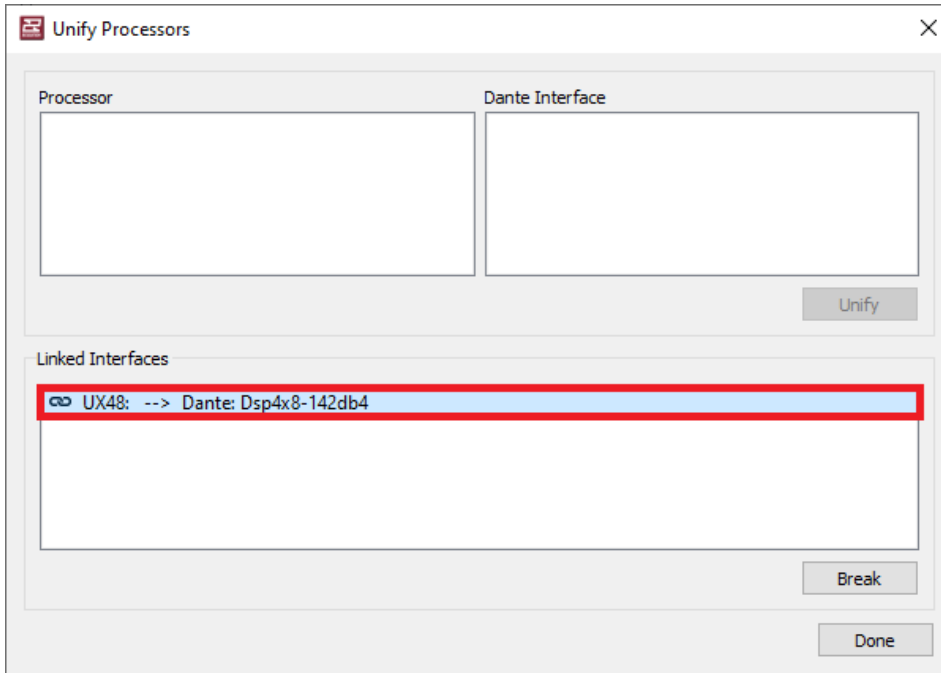

Under Online Devices, Resolution now associates the Dante card with the processor or amplifier.

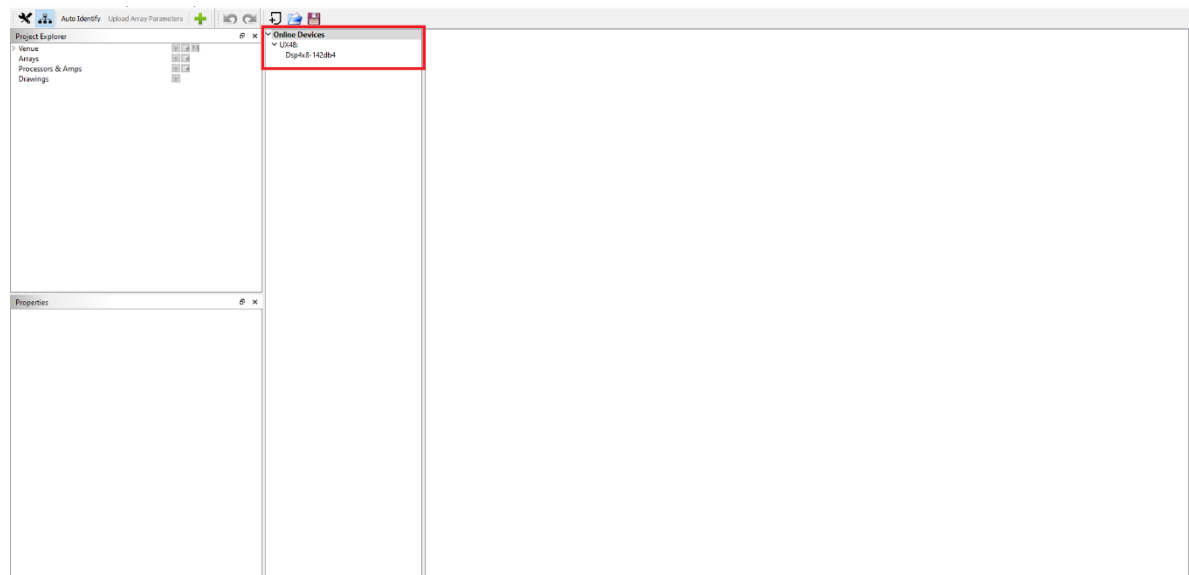

Section 5 - Entering 3D Audience Areas

Familiarize yourself with Resolution's features by going over **Section 3 - Getting Around Resolution** before starting to model your venue.

Modeling Basics

When you first open Resolution, you will be met with a very basic venue setup. This is a starting reference which will show a single, small surface and the Front of House mix position.

Because we are working in 3D, it will be important to understand and remember the axis you will be working with.

X = Depth (red line)

Y = Width (green line)

Z = Height (blue line)

As you free rotate around the model, these references will track along with your moves to remind you of your viewing perspective to the model.

You will also notice that the entire model is set up on a grid. When working with Imperial units of measurement, these grids are setup in 10' x 10' divisions. When working with the metric system, the divisions of the grid spacing are 5m x 5m.

Zoom - You have the option of using the mouse wheel to roll in and roll out on your model, or you can hold down the CNTRL key while depressing the + or - keys on your keyboard. Plus will zoom in and minus will zoom out.

Pan - First hold down the SHFT key on your keyboard and then left click and hold your mouse in any free area of the model not already containing room or array model images. Now simply move your mouse left, right, up or down to pan around your model.

Rotate - When in three dimensional view of your model, global rotation is achieved by again finding a free area within the model, left clicking on your mouse and moving your mouse around to allow for global movement around your model.

Front of House - It is important to be able to see what the engineer will hear and where they will be placed as this will have an impact on the overall result of your design. Placing the Front of House position seems basic but it is very important to your overall design result. Left-click and hold on the Front of House position to freely position it around the listening surface.

Editing Surfaces

- As you hover your mouse over a surface, you will notice rectangular blocks that become visible on each side of the surface and squares that become visible on each corner. These blocks allow you to grab and alter the dimension of the surface. This is a coarse way of adjusting a surface but once roughed in, editing the dimensions is easy using the Properties pane.
- Once a rectangle on a surface has been selected by left-clicking and holding on it, you are able to pull on that surface from the rectangles location. Raising or lowering your mouse while holding the rectangle will adjust the inclination of the surface on that particular side.
- Left-clicking and holding a square on each corner of the surface adjusts all sides together allowing you to increase or decrease the entire size of the surface while also allowing transformation from square to rectangular surfaces. Inclination changes are not available with the corner squares.
- Multiple surfaces can be 'merged' and controlled at once. This is done by selecting a surface, then holding the CTRL key while selecting another surface, and repeated for as many surfaces as desired. This group of surfaces can then be edited as one in certain ways including: deleting, hiding, locking, or toggling them as audience/non-audience areas.

Surfaces (Polar Data Entry Mode)

Beginning with a new file, Resolution opens with a surface already in the Venue View that has starting coordinates of (0, 0, 0). When you select this surface, you can see all of its values in the **Properties** pane, including a default value for the length and width of the surface.

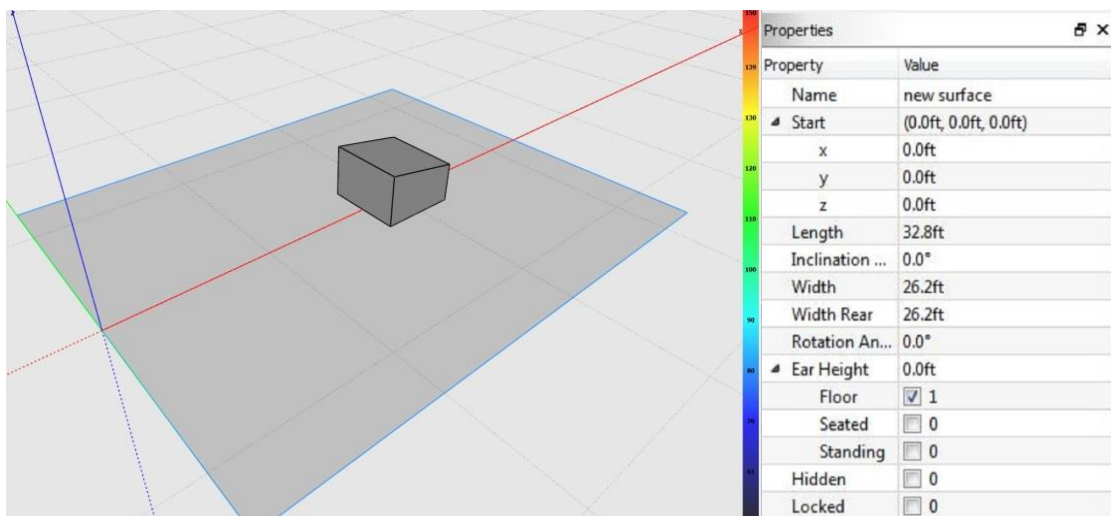

The selected surface is highlighted in blue in the Venue View. The origin of the model is important to understand as it will have an effect on the flow of work.

The direction you choose to take will impact where the origin lies. If you are only concerned with what's happening in front of the arrays, you can simplify the build by starting your model at the origin. You may also use the origin to show the center of the room and build around that origin 360 degrees OR you can leave the origin with the arrays and still build behind it. There are no restrictions so choose the best way to model your venue to get the best results.

For our first example, we will leave the origin with the arrays representing the downstage edge of the stage.

We will work through the **Properties** pane setting the values for our surface. It is best practice to enter a **Name** for the surface to keep track of each surface as you move along creating your venue.

1. Enter the **Start** values. The Start coordinates refer to the front center of the selected surface. From the desired room origin of your venue, determine the values of the starting coordinates (X, Y, Z) of your first surface and enter them into the values side of X, Y, and Z in the **Properties** pane.

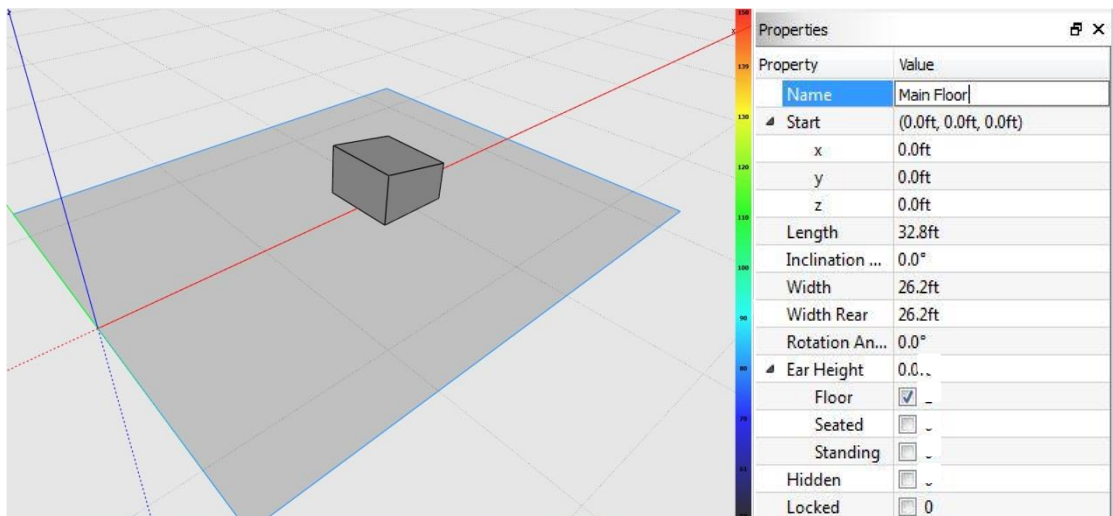

Since we are doing a simple model, we will leave the **X**, **Y**, and **Z** origins at zero. This means that the surface will be centered with the Y dimension and it will begin right at the X and Z origin lines.

Since this model will represent a theater, we will assume the listeners in the audience are seated. Check the 'Seated' box in the 'Ear Height' section of the **Properties** window. This will direct the acoustical calculations to be made at a typical ear height for a seated audience (3.5 feet).

2. Enter the **Length** and **Width** values of the surface. Measure the length (distance along x-axis) and width (distance along y-axis) of just this surface, and enter the values into the **Properties** pane while making sure the surface is still selected.

Let's enter 200' as the **Length** of the surface and 100' as the **Width** of the surface. You will notice that all the changes are reflected in your model in the Venue View.

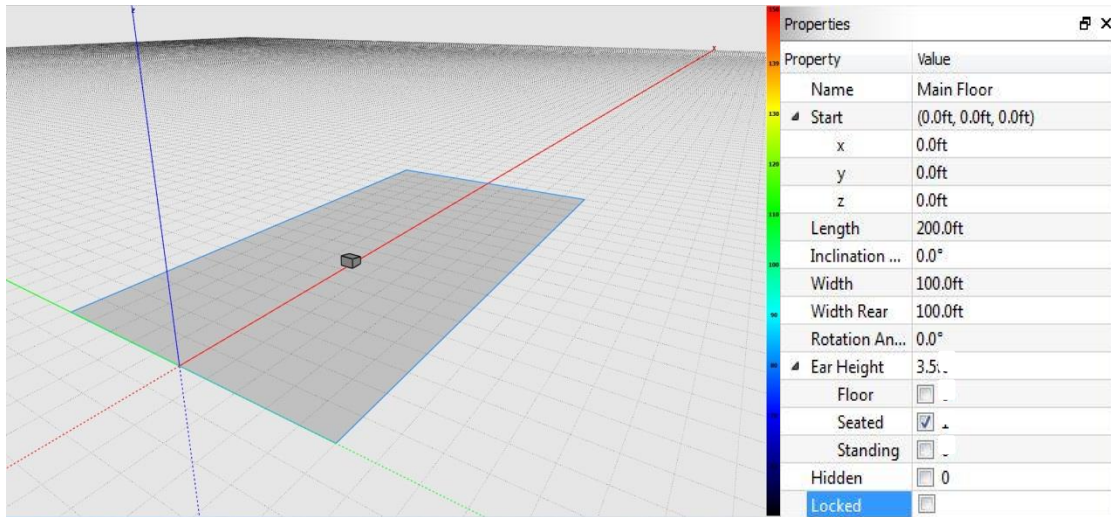

Remember: the **Width** measurement expands equally in both directions from the starting point of the surface, so your surface is still centered along the x-axis.

3. The next cell down is the **Inclination Angle**. This is to set a rake of the surface. The surface will begin an inclination beginning at the origin, and will incline on an angle that you determine. Inclination angles can be determined from room drawings but may also be determined on-site using an inclinometer tool.

For our simple example, we have chosen 2 degrees as the Inclination Angle.

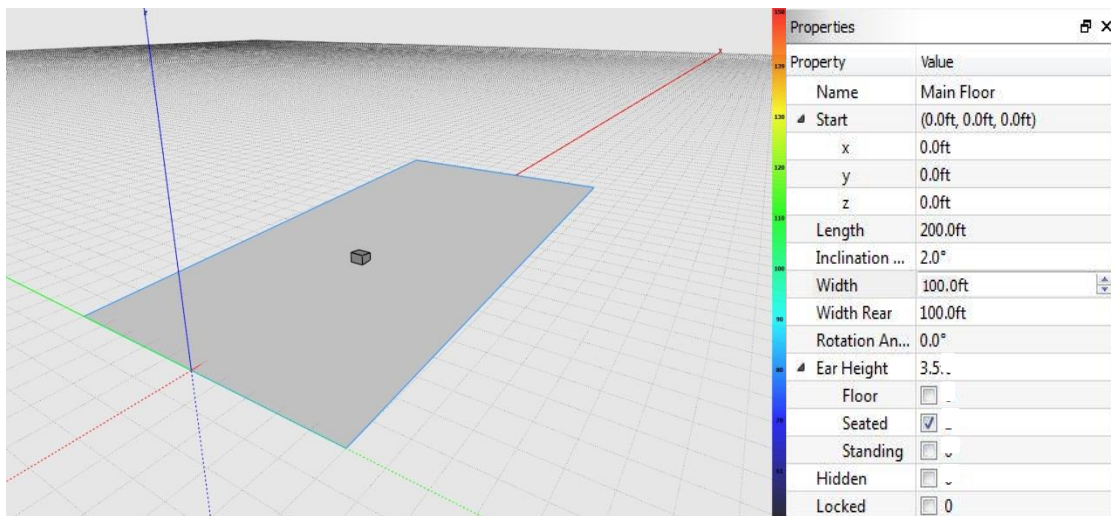

4. The next cell down is the **Rotation Angle**. In our simple model we will not need to rotate the surface, but in complex models this can be very handy especially when



designing curved areas like the back of an arena.

5. Finally, there are two boxes that can either be checked or unchecked:
 - **Hidden** - This is used when you want to omit the surface from SPL calculations. As an example, maybe you are only interested in viewing the main surface of a venue and there is a balcony in the way. By hiding the balcony, it will be disregarded in the SPL calculations even though it is still there and visible as an opaque surface. Simply uncheck the box to bring the surface back into the model for calculation.
 - **Locked** - Many times during the creation of a model, the user may inadvertently move parts of the model while creating or viewing other items. By checking the “Locked” button, the user can be assured that the current surface cannot be moved accidentally or altered without unlocking it first.

Now that the main surface is completed, go ahead and free rotate around the model to get used to viewing things from different angles. You can also snap to a section or plan view using the snap buttons located on the toolbar at the top of the screen.

Options for Adding a New Surface

There are two options for adding a new surface to your venue. Let’s get an understanding of the difference between them before moving along in modeling our venue.

1. To add a surface from scratch, select the  icon to the right of Venue in the **Project Explorer** pane. This will add a surface with the starting coordinates (0,0,0) in your **Venue View**. To save time, you could also right-click anywhere in the **Venue View** and select **Add Surface**. This will create a surface with the starting point located at where you right-clicked. You can then alter the properties of this new surface in the **Properties** pane, as we have done for the previous surface.
2. To **Clone** a surface, switch to the **Project Explorer** pane and click the  icon to the right of the surface you wish to clone. This can also be done by right-clicking on a surface and selecting ‘**Clone Surface**’.

Once clicked, a window will come up on the screen for you to modify the conditions of the cloned surface. By just accepting it “as-is” the new surface will simply overlay the old surface and will not be visible. Making changes to the new surface using the cloning pane is as follows:

- **NAME** - select a name for the new surface
- **MIRROR** - There are two ways to mirror a surface
 - **X** - Mirror the surface against its X axis
 - **Y** - Mirror the surface against its Y axis
- **OFFSET** - You can preset new coordinates for the surface prior to it being cloned. These coordinates can be set on all three axis’ (X,Y,Z).

Once you have set the parameters and coordinates for the cloned surface, simply click OK and the new surface will be created in the model. Most often, this will only be a rough placement that we will have to adjust, but it can be a little quicker than starting from scratch each time.

Adding A Balcony (Polar Data Entry Mode)

We want to add a balcony above the Main Floor in our model. Using the clone feature we can copy the width of the venue to the new surface even though all the other parameters will need to be entered manually.

1. To the right of “Main Surface” in the **Project Explorer** pane, click the **Clone** button, which will open up the cloning pane for us to set new parameters and coordinates for the cloned surface.

Define a new name for the surface “Balcony”

If you already know the coordinates of the balcony, you can enter some of them under **Offset**.

- **X** - Where will the balcony face begin along the X Axis? (enter 100')
- **Y** - Where will the balcony face center along the Y-Axis? (leave at 0)
- **Z** - How high will the balcony be at its front edge on the Z-Axis (enter 25')?

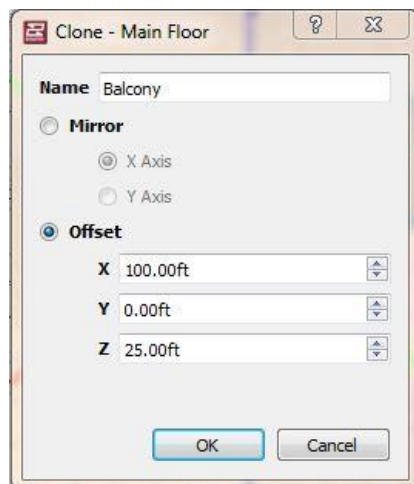

Hit the **OK** button and the Balcony will be added to the model.

2. Define the **Properties** of the cloned surface.

You will notice in the model that the **Length** of the balcony is still 200' which is not what we want. Select the new surface in the **Project Explorer** window which will reveal all the data of that surface in the **Properties** pane.

We should be happy with the name and origin of the surface because we defined these when we made the balcony, but you are able to alter them if needed.

Length - Reduce the length of the balcony to 100'

Width - The width can remain the same.

Inclination Angle - Set the inclination angle to 10 degrees.

You can now choose to **Hide** and / or **Lock** the balcony.

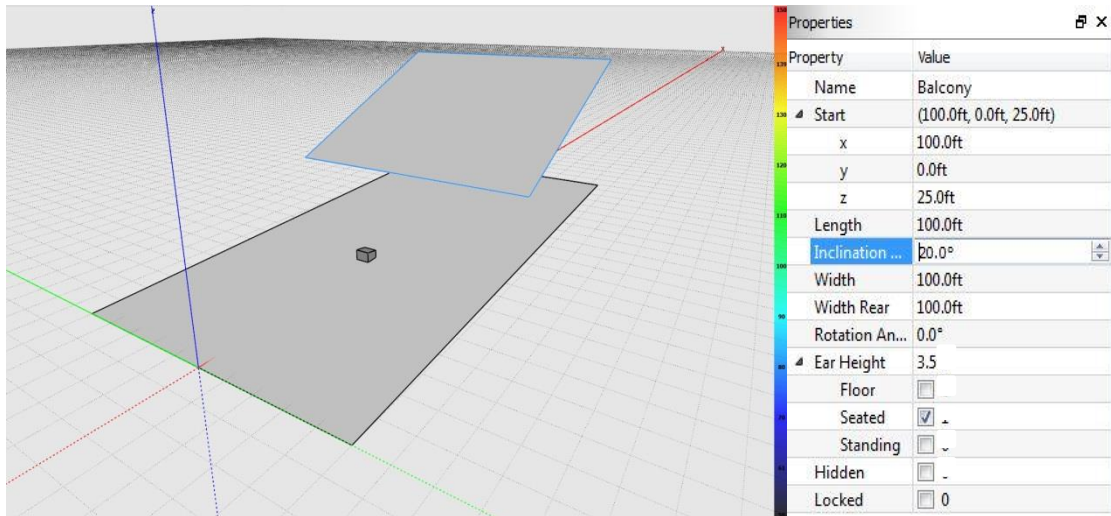

Now we can see a relatively basic venue setup comprised of two surfaces: a main surface and a balcony.

Front of House Position

One item that we should also consider altering is the position of the Front of House. It is extremely important to know what the engineer will hear when the audio is playing so placing the front of house accurately within the model is important.

1. In the **Project Explorer** select "Venue" and the Front of House properties will appear in the **Properties** pane.
2. For our model, let's leave the **Front of House** position on the Main Surface but let's move it to a little bit better location than where it currently is in our venue.
 - Let's start by changing its **X** location to 75'
 - Let's put in 10' in the **Y** location which will move the Front of House position 10' to the right. A negative value would have moved it to the left.

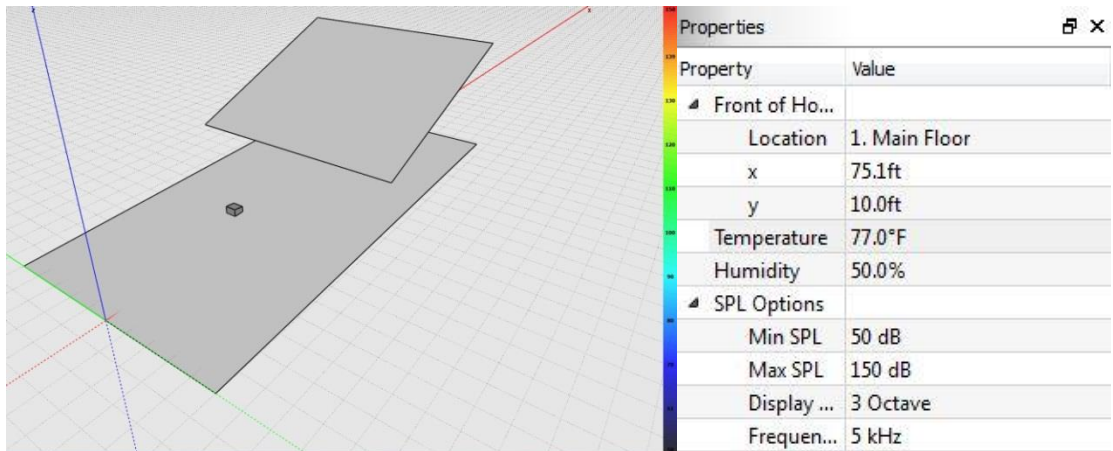

Adding a Stage (Polar Data Entry Mode)

1. Start by adding a new surface to the model.

This time to add a surface we will use the **Add surface** option in the **Project Explorer** window next to **Venue**. Simply hit the + button a new, generic surface will be added to the model. We will have to manually enter in the data for this surface and since we are using it to build a stage, some negative values will be used. Once the surface is created, it automatically highlights and its parameters are shown in the **Properties** pane.

2. As we did earlier, begin by giving the surface a name. This one will be called Stage.
3. Now we need to set the origin of the surface. Since the stage will be behind our origin marks, we will enter in an X-axis origin that is equivalent to the depth of the stage. This value will be entered as a negative value because we are going backwards.
 - Our stage is 30' deep so the value entered for the **X**-axis origin will be -30'
 - Our **Y**-axis origin can remain at 0 keeping the stage centered on the origin.
 - Enter 4' as the **Z**-axis origin.
4. Now the depth of the stage should match the negative offset that we put in for the X-axis origin. This will place the downstage lip precisely back to where the audience begins. Since our X-axis origin was placed at -30' for this venue, we simply enter in 30' for its **Length** and it will come back to the audience line.

A typical stage **Width** is usually around 40' in width so let's enter that as our width.

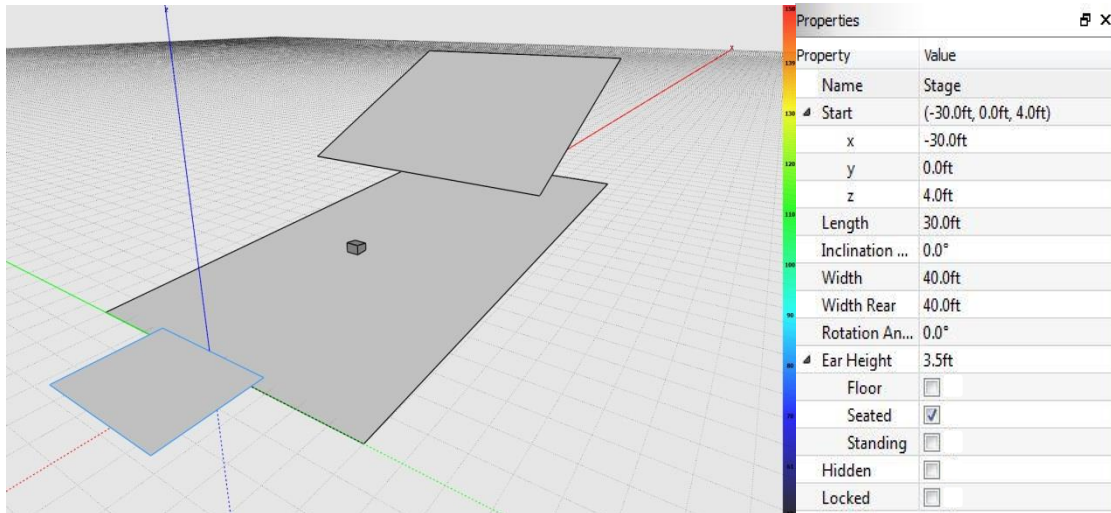

Hiding the stage from the SPL calculations is optional but locking the stage once it has been properly defined is a very good idea to prevent accidental changes to it. If all of the surfaces that you have created are locked, you can now freely rotate the model without any fear of accidentally dragging surfaces out of position or changing their dimensions.

Adding Sides (Polar Data Entry Mode)

Let's begin again with a new model so that we can create something more similar to an arena type design.

Create a new Resolution file and the default layout will be presented.

1. Select the surface in the Venue View, or go to Venue in the **Project Explorer** pane and expand it to show the surface that is visible. It will be default labeled as "new surface". Before going further, let's give the surface a proper name. We are going to call it Main Floor.
 - **X, Y, Z** origin of the surface - Since we are going to leave our position at the origin of the software, we will leave X, Y, and Z coordinate values at '0'. Select 'Standing' ear height.
 - **Length and Width** - to keep things simple, let's work in full numbers. Set the length of the surface to 200' and the width of the surface to 100'

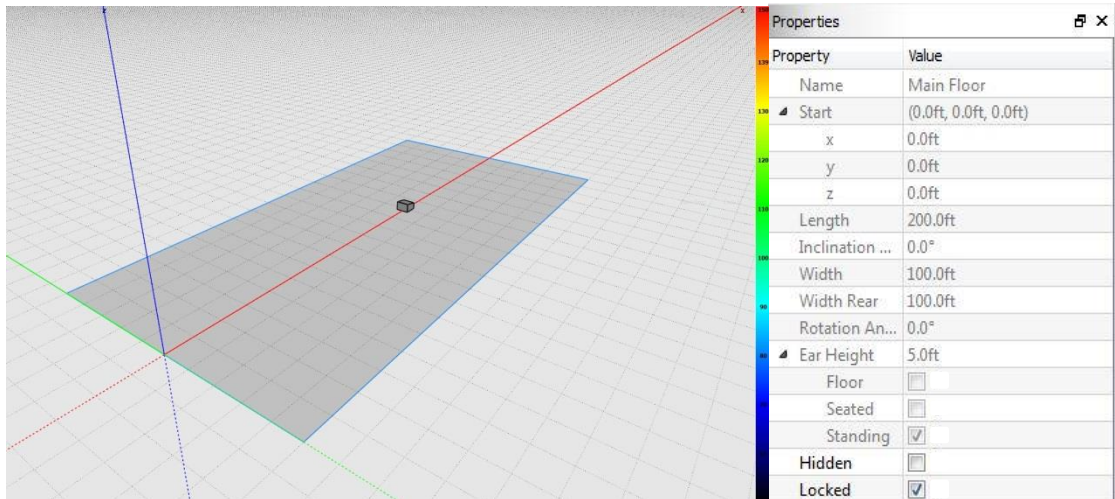

2. Next, we want to include a raked seating area at the back of the house to represent bleachers. In the **Project Explorer** in the venue area click on the green + button to create a new surface. The new surface will be displayed with the default name so we want to change the name to North Rake in the **Properties Pane**.
 - **X, Y, Z** - Since the first surface was 200' in length, set the X origin of the raked surface to 200'. The Y origin can remain at 0 since we are going to remain centered.
 - **Length and Width** - Set the length of the raked surface to 75' and the width to match that of the main surface at 100' wide.
 - **Inclination angle** - Let's put in 20 degrees as the inclination angle. Now you can see the model taking shape.

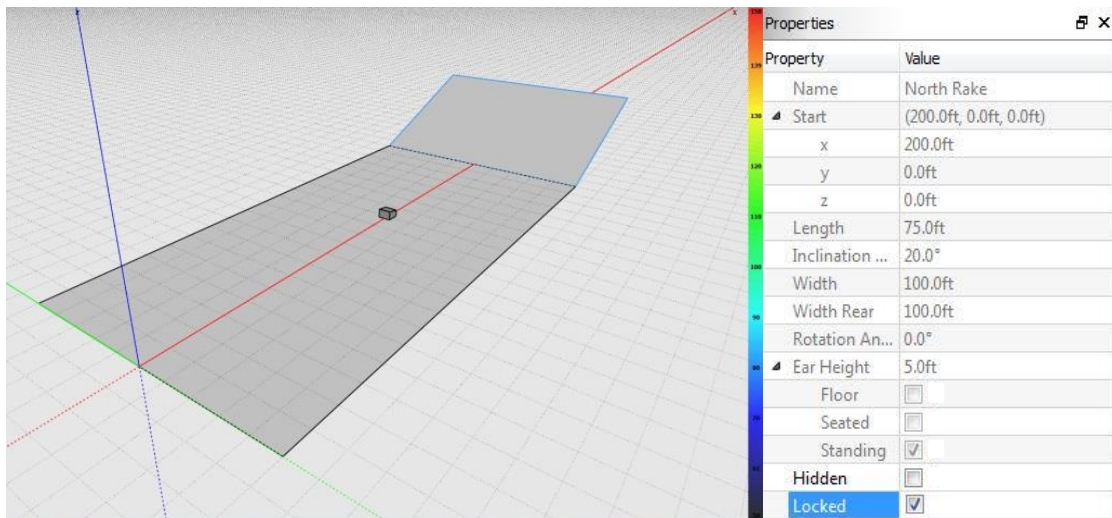

3. Next create a new surface in the **Project Explorer** pane. To keep track of the surfaces in our model, let's call this surface the "West Rake".

To simplify a few things, we are going to work this surface in the **Properties** pane

from the bottom up. This is because the Rotation Angle is taken from the center point of the surface, so when adding a Rotation Angle, the starting coordinates change. ***It is best practice to add the Rotation Angle first so you do not have to enter the starting coordinates twice.***

- **Rotation Angle** - rotate the surface 90 degrees. This will place the orientation of this surface at a 90 degree relationship to the main floor surface. If you look at the origin of this surface now you will see that it is not all zeros anymore. It is displaced due to the rotation of the surface.
- **Inclination Angle** - set to 20 degrees just like the rake at the back of the venue.
- **Width** - The width of the surface should match the length of the original surface so that they line up. Enter in 200' for the width of the surface
- **Length** - translates into the “depth” of the surface when the orientation has been shifted to expand along the Y-Axis over the X-axis. Set the length of the surface to match the length of the North Rake, which is 75’
- **X, Y, Z** - Since this surface starts halfway through the width of the main floor surface and the main floor surface is 100’ wide, it is simple to figure out that placing the surface along the Y-axis should be 50’. Since the surface **Start** point is halfway down the length of the main surface, it is easy to determine that to place the X-axis we would say 100’

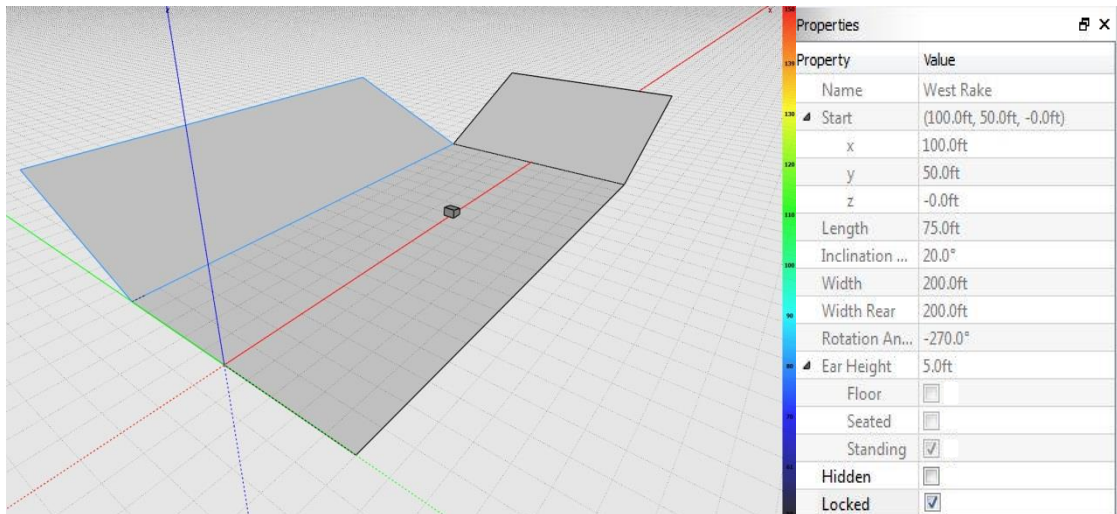

4. To create the rake on the other side is exceptionally easy using the cloning feature. Simply select the raked surface that we just created up in the **Project Explorer** window named West Rake. Next to that title you will find the “clone” button. If you click that button, you will be greeted with the clone window. You could also right-click on the West Rake and select **Clone surface**

Since we are only cloning the surface and not repositioning it, we are only worried about using either an X mirror or a Y mirror. The X mirror will create an exact but opposite version of the surface placed along the X axis. The Y mirror will do the same across the Y-Axis. Since we need an equal but opposite surface on the other side of the venue, we will select a cloned surface mirrored to the X-axis.



We named this surface “East Rake” and locked it.

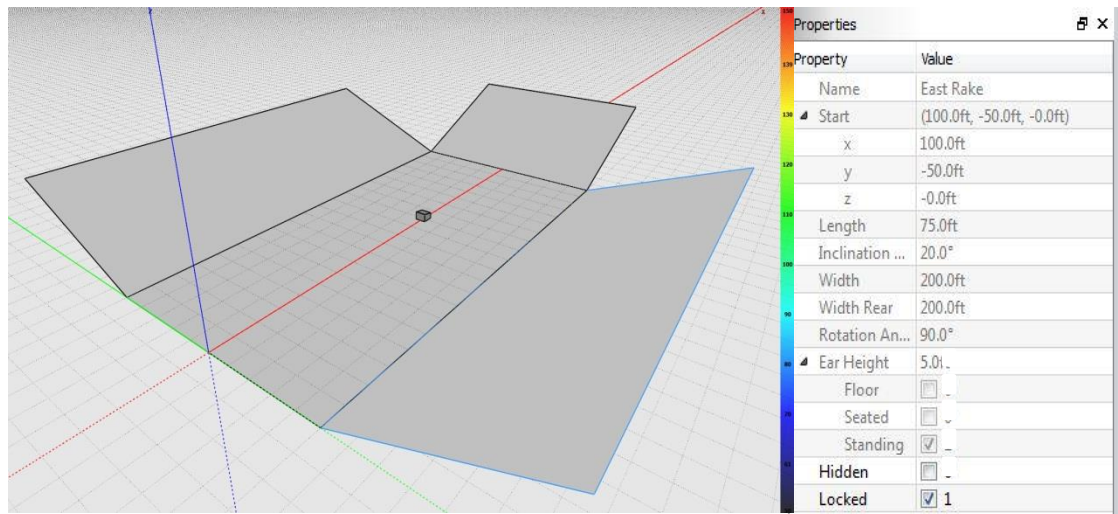

Adding Corners (Polar Data Entry Mode)

Now that we have added rakes to our basic venue, you will notice that there are gaps left open at the corners. We will need to create rotated surfaces to cover these areas.

1. Start by cloning the North Rake because it has similar dimensions to what we need for the corners. Remember that we only need to actually position one corner because we can clone it to the other side when we have the first one positioned correctly.

Clone the North Rake to mirror the X-Axis. You will not be able to see the new surface because it will completely overlay on the old surface. The best thing to do is as soon as the surface has been created is to head to the **Properties** to change the name of the surface to differentiate between the two. We have called this corner West Corner.

- Now again, let's work through the **Properties** pane from bottom to top to place the West Corner.
 - Rotation Angle** - set to 45 degrees to cut the angle between the West Rake and the North Rake.
 - Inclination Angle** - let's increase this to 28 degrees for a steeper incline up the corner seating.
 - Width** - leave at 100'
 - Length** - shorten to 55'
 - X, Y, Z** - since the origin is from the front center of the surface, we know we want that right at the northwest corner point of the Main surface. Since that surface is 200' long in the x-axis, 200' is our **X** start. The Main surface is 100' wide in the y-axis split across the x-axis, so our **Y** start is 50'.

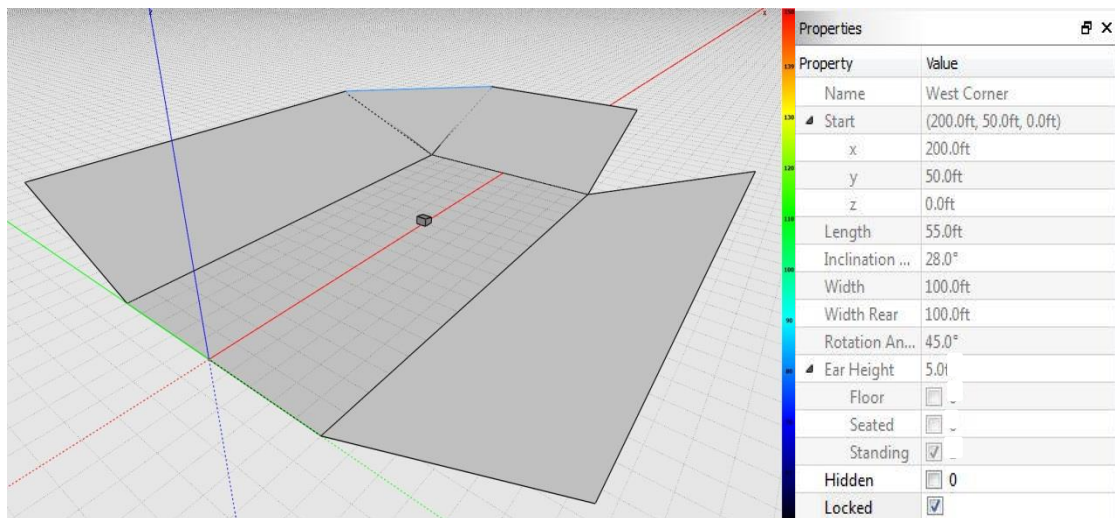

- To create the East Corner, just clone the West Corner and mirror it across the x-axis.

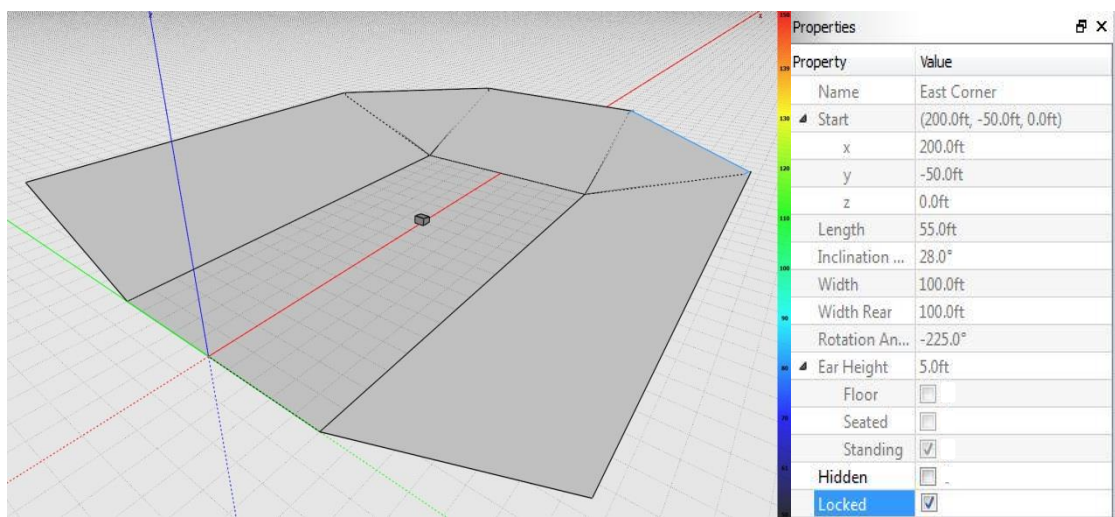

You have now completed a model of your venue. If you have forgotten to **Lock** your surfaces along the way, simply select the  icon in the toolbar to lock all of your surfaces at once so you can free rotate around your model without accidentally moving any of your surfaces.

Entering Surfaces – Alternate Methods

In addition to the standard polar surface entry method described above, Resolution allows surfaces to be entered into a model by Cartesian and Laser methods. The surface entry method can be selected by selecting **Venue Measurements** from the “Options” drop-down menu.

Cartesian Entry Method – Using this method, surfaces are defined by a ‘start’ and ‘end’ point. Each of these points is defined by (X,Y,Z) coordinates. The width of the surface is defined separately, just as it is using the standard surface entry method. Rotation and inclination angles are automatically defined based on the location of the ‘start’ and ‘end’ coordinates. This method can be useful if accurate electronic venue CAD drawings are available, since the user can simply ‘pick’ the coordinates needed for each surface.

Laser Entry Method – The Laser entry method allows the user to enter surfaces into the model based on site measurements using a laser measurement tool. The origin of the model serves as the measurement location and surfaces are entered based on their relative position to that point.

Eye Height – Defines the ‘Z’ value of the measurement point.

Start Distance – Defines the distance from the origin to the front edge of the surface.

Start Angle – Defines the vertical angle from the origin to the front edge of the surface. This angle is determined by the ‘eye height’, and the distance from the origin to the surface edge.

Start Rotation – Defines the horizontal rotation from the origin to the midpoint of the front edge of the surface.

End Distance – Defines the distance from the origin of the model to the rear edge of the measured surface.

End Angle – Defines the vertical angle from the origin to the rear edge of the surface.

End Rotation – Defines the horizontal rotation from the origin to the midpoint of the rear edge of the surface.

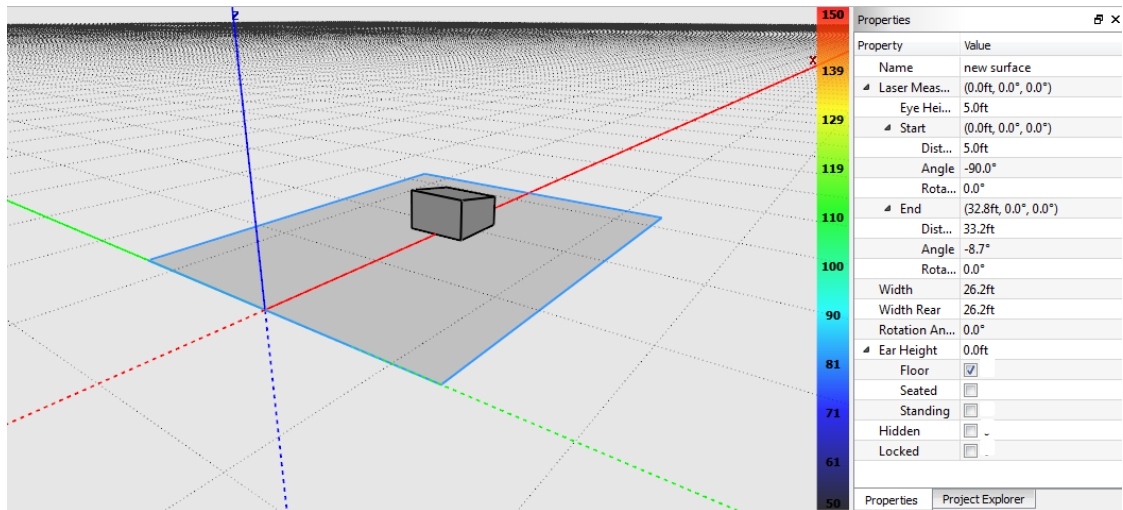

All measurements are based from the origin, taking into account the 'Eye Height' value (default value is 5'). Using the default surface when opening a new Resolution model as an example, the origin's (X,Y,Z) coordinates are (0,0,5). This point will be referred to as the origin when using the Laser surface entry method.

The starting distance is 5', with an angle of -90°. This represents the distance from the origin to the position with coordinates (0,0,0). Since the front edge of the surface is horizontally centered on the origin, the rotation angle is 0°.

The end distance, 33.2', is the length from the origin to the midpoint of the rear edge of the surface, and corresponds to an angle of -8.7°

Surfaces (Laser Data Entry Mode)

Let's recreate the arena venue we entered before, this time using the Laser entry method. Begin by adding the surface of the arena floor. The first measurement to take is the midpoint of the front edge (at our feet), followed by the midpoint of the rear edge of the surface. The width of the surface is determined by measuring the distance from our position to the end of the surface along the 'Y' axis, and doubling it to take into account both sides of the floor.

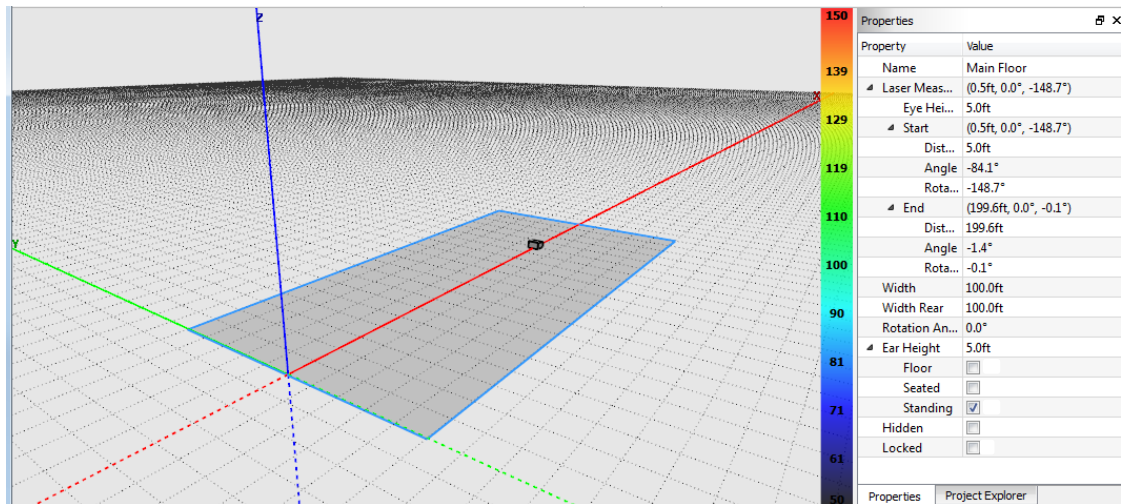

The next step is to add the surface we referred to as North Rake. Again, measure the distance and angle to the midpoint of the front and rear edges of the surface. Since we are on axis with this surface, no rotation measurements are required.

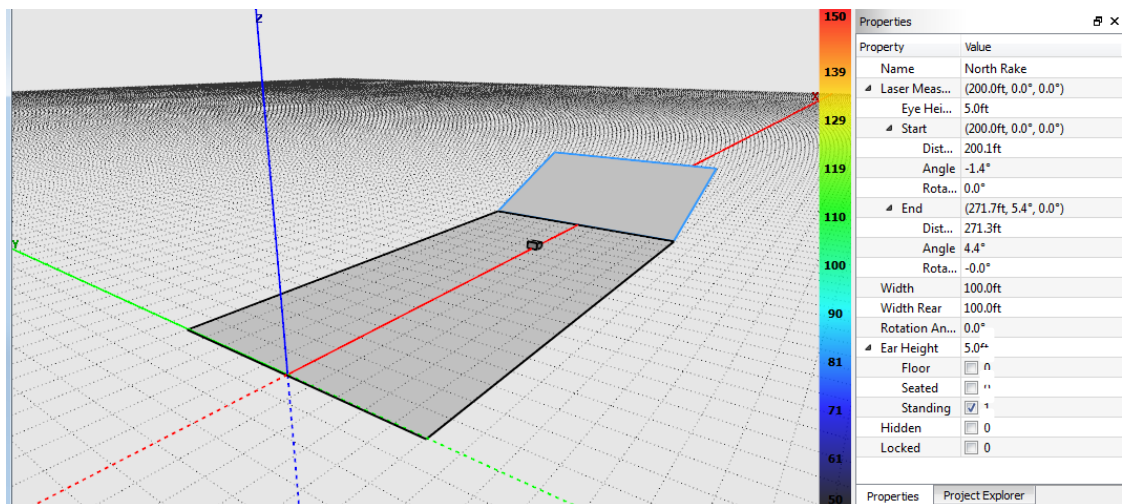

The front and rear width of the North Rake can be determined by measuring the horizontal angle (rotation) between the center of the edge of the surface and the right or left hand edge. Once this angle is measured, simple trigonometry can be used to determine the width value. Repeat for both rear and front edge of the surface. Alternatively, the user can move to the surface in question and use the measurement tool to directly measure the width.

Adding Sides (Laser Data Entry Mode)

The next surface to be entered is the West Rake.

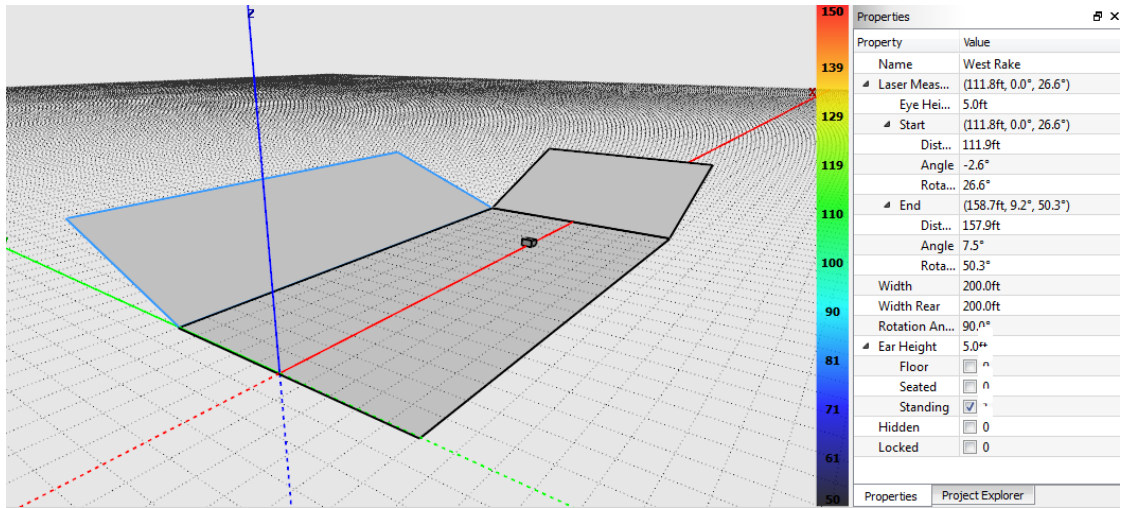

Again, the measurement tool is used to determine the distance, angle, and rotation to the center of the front and rear edges of the surface. The horizontal angle from the origin to the left and right edges of this surface can be used to determine the width of the surface. Repeat for both front and rear edges.

Adding Corners (Laser Data Entry Mode)

The final surface to be measured is the corner. The point of intersection of the North and West Rake surfaces will be the measurement point for the front edge of this surface. The rear edge will be measured as before.

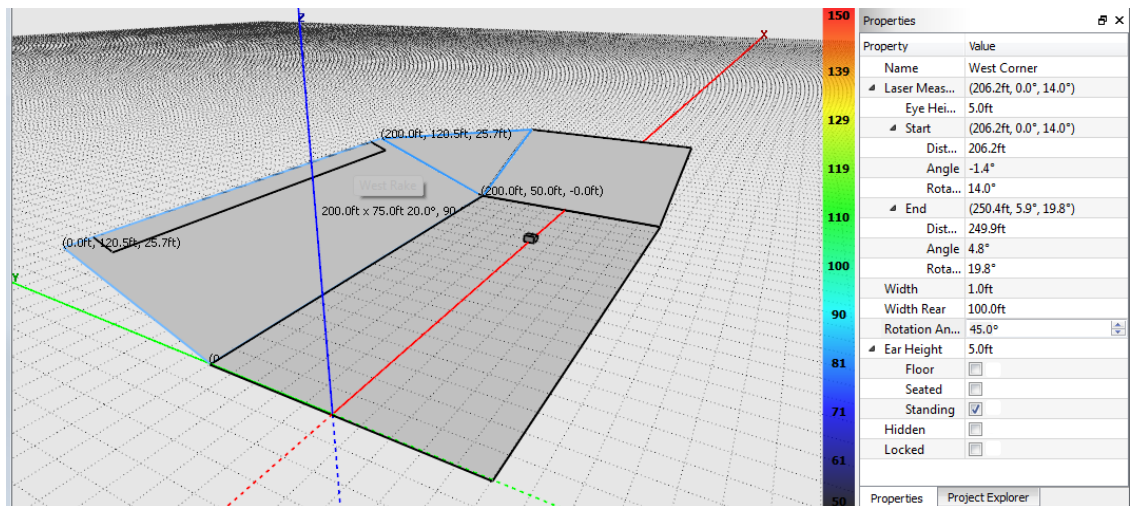

Since the front edge of the surface is essentially a point, 1' can be used as the front width. The rear width is more difficult here because of a lack of right angles in

relation to the origin. Fortunately, with surfaces defined on either side, the rear width value can be estimated until it fits between the other surfaces.

Image Import

Resolution allows the user to import images of architectural drawings that can be overlaid across Resolution surfaces. This allows for simpler model creation and also provides a more detailed visual picture when running SPL maps to evaluate system performance.

Selecting 'Image Import' from the 'File' menu opens the dialog window.

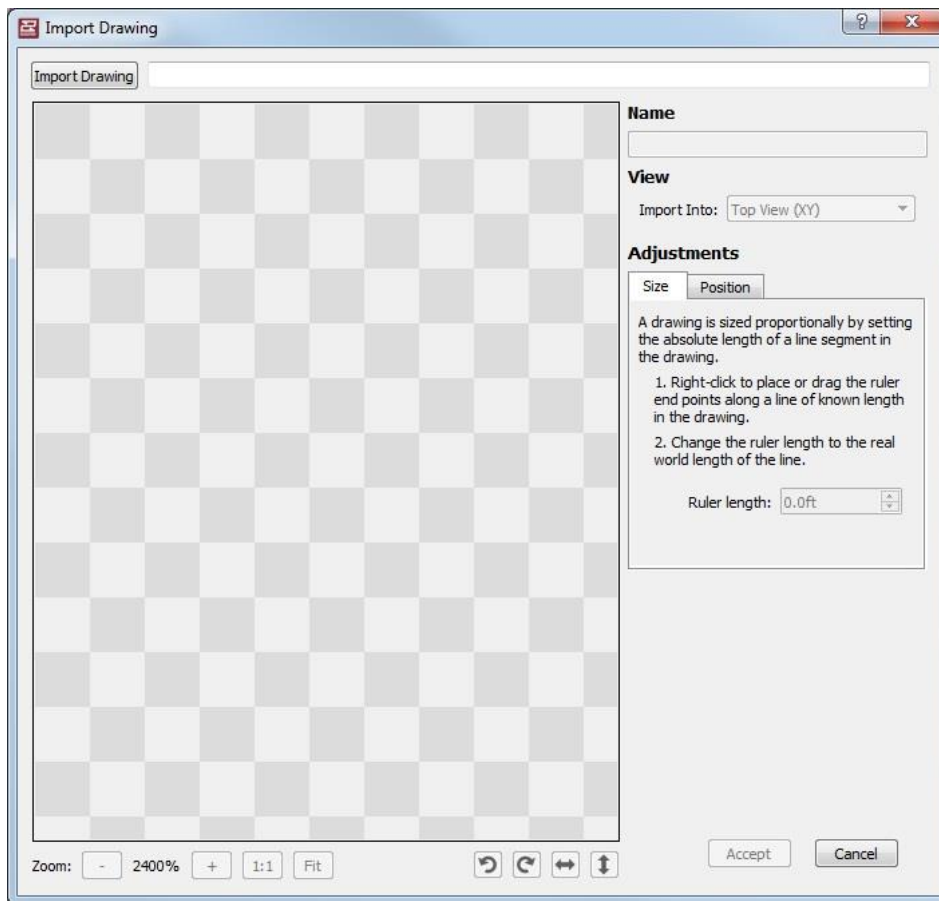

Selecting 'Import Drawing' allows the user to browse their PC to import the drawing of their choosing. Once a file is selected the user can select whether the drawing is a plan or section drawing from the drop-down menu under 'View'. This will determine the orientation of the drawing when it's placed in the model.

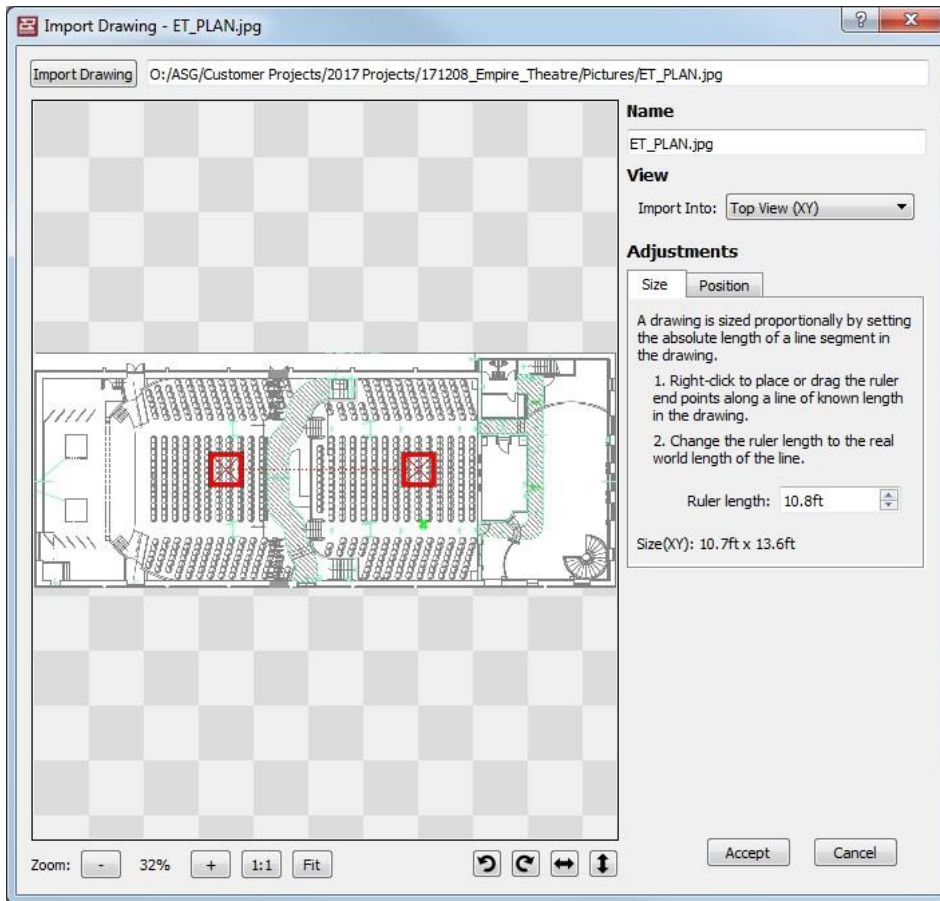

The 'Adjustments' section allows the user to do two things: scale the drawing (size), and determine the relative position in the model the drawing will be placed (position).

'Size', or scaling the drawing, is done by clicking and dragging the two red squares to points in the drawing where the length is known (this could be a dimension written in the drawing, or a doorway, etc). Once the squares have been moved the user enters the length of this dimension in the 'Ruler Length' line, and the drawing will be scaled.

For example, in the image below, the squares have been moved across a double door. Since these are standard sized doors we know the length of this dimension is 6 feet, and have entered that into 'Ruler Length'. The drawing is now scaled.

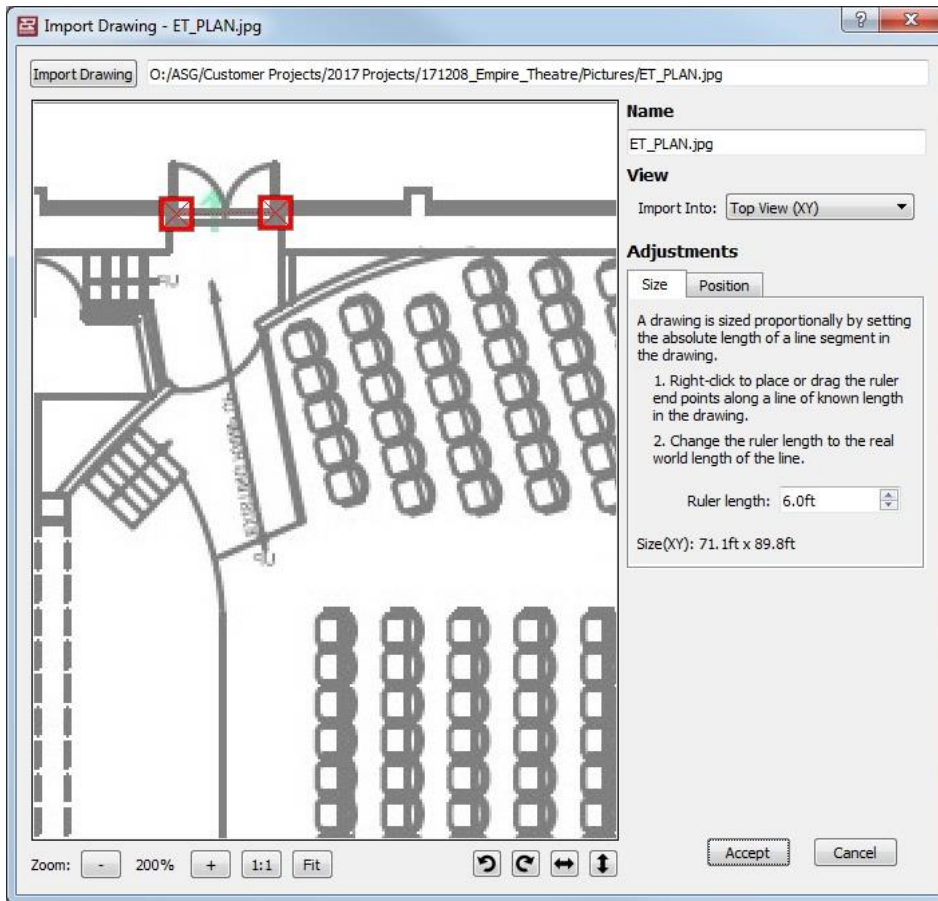

Next step is to determine the position of the drawing in the model. This is done by selecting the 'Position' tab, then clicking and dragging the blue 'X' to the desired point in the drawing. The user can then enter the X,Y coordinates in the model they want the blue marker to be positioned in. The most typical use of this feature is to leave the coordinates at 0,0, the origin, and simply drag the blue 'X' to the point that will be the origin of the model, like in the image below where the marker has been placed at the center down-stage edge.

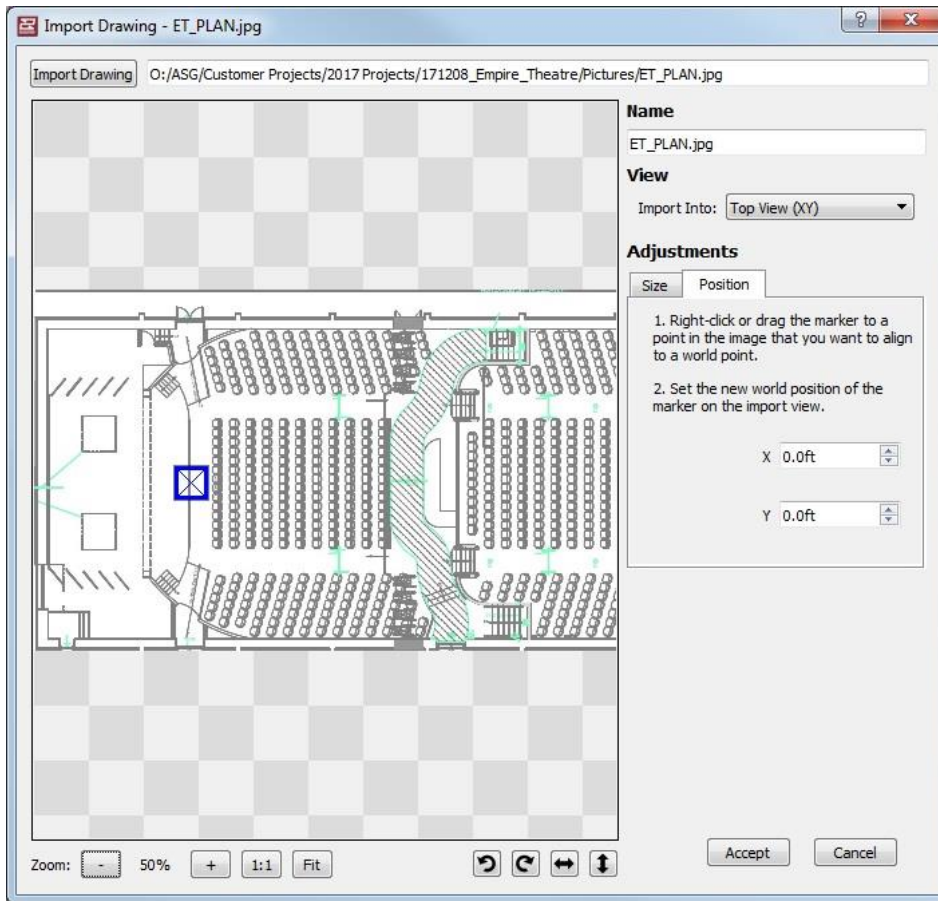

The examples above have all been shown from the 'Top' view, but the same principles apply to 'Side' view drawings as well.

The buttons at the bottom of the window allow the user to zoom in and out, zoom to actual size, fit image to view, rotate in 90° increments, or the shift the view. Pressing 'Accept' will place the drawing in the model and return the user to 'Design' view.

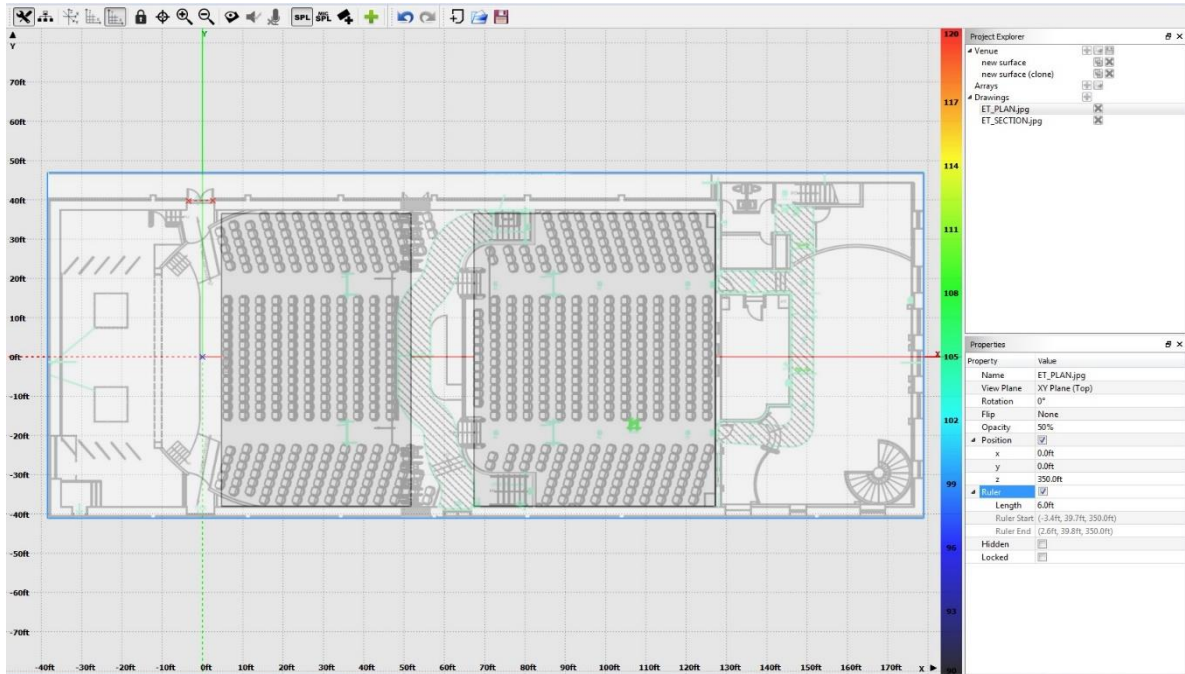

In the image above the drawing has been placed in the model and the audience surfaces has been sized to match the seating areas. In the 'Properties' window the opacity of the image can be adjusted to determine the ratio of visibility between the drawing and the surface. The image below shows the same venue but with a section, or side, drawing.

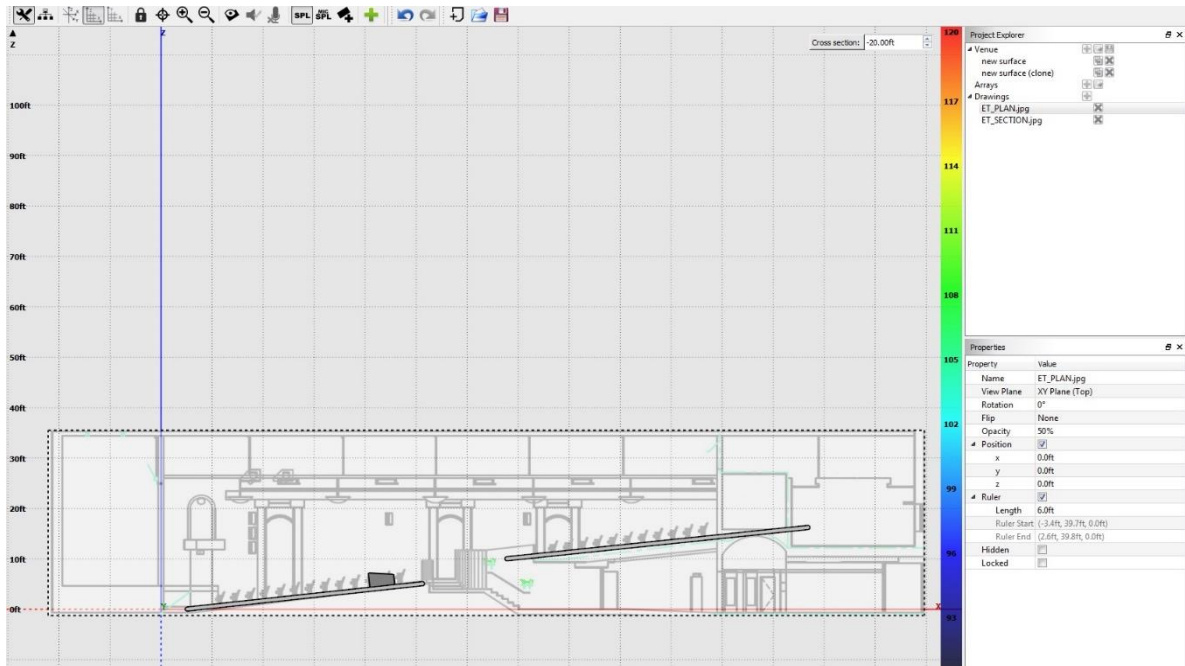

Saved Acoustic Models (SPL Map & Adaptive Settings)

Acoustic SPL map and all steering settings are now saved with the Resolution file, allowing for quick display of SPL map upon loading a file, and quick upload of settings.

Once the model is done calculating, a model may be saved by selecting File>Save Acoustic Model.

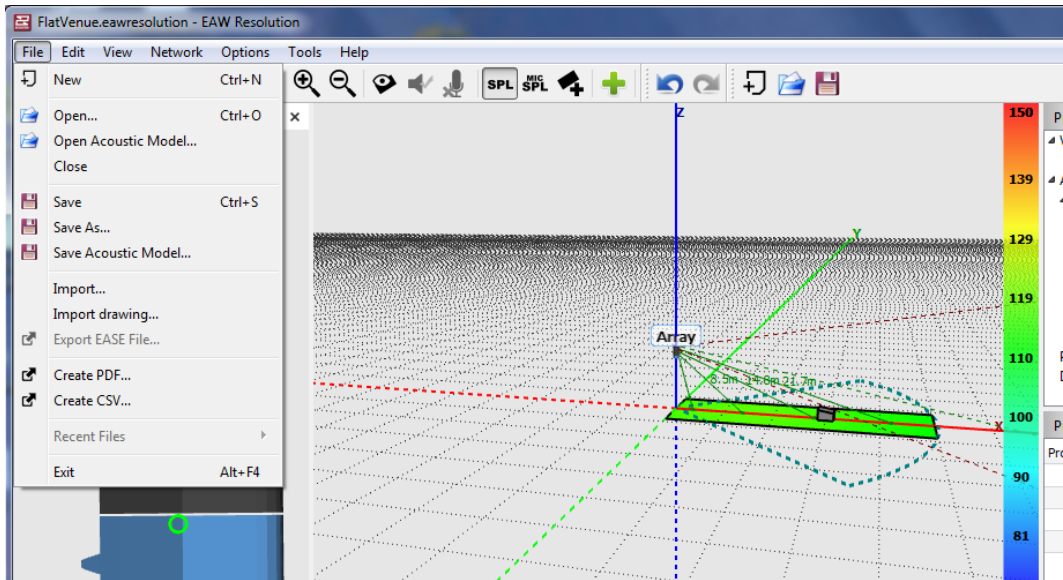

Fig 1. Save Acoustic Model option

The below dialog will appear with what will be saved within the acoustic model file.

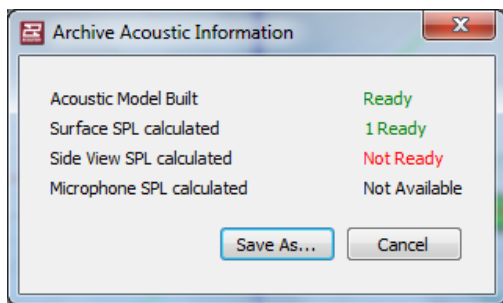

Fig 2. Acoustic Info: display of what's available to be saved

Name and select a location to save the file.

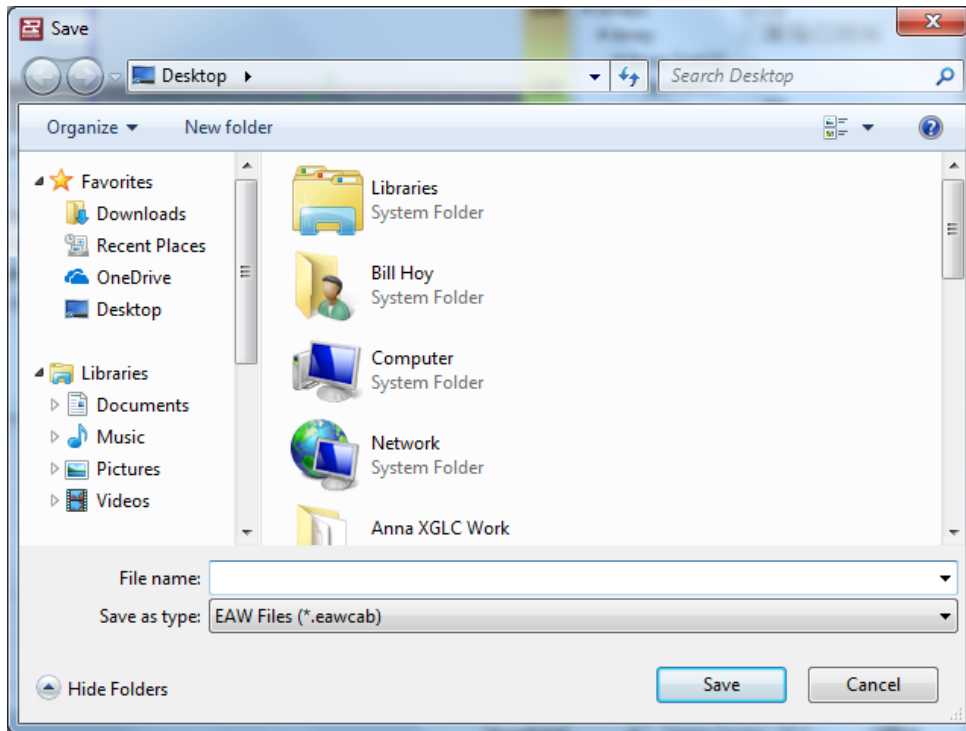

Fig 3. Save as *.eawcab

To load a saved model, click File>Open Acoustic Model (refer to Fig 1 menu). Browse to the location of saved *.eawcab file. Select file then Open.

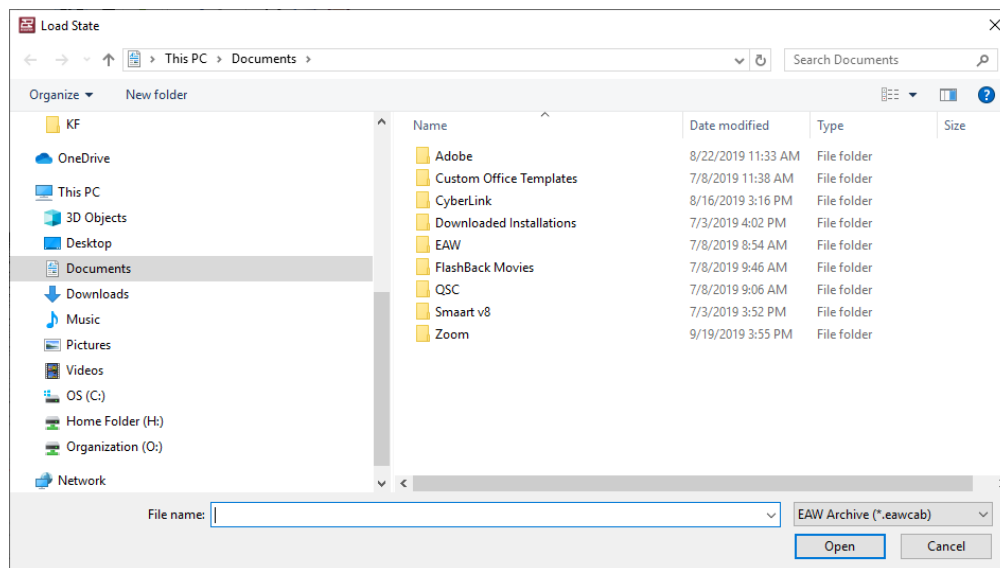
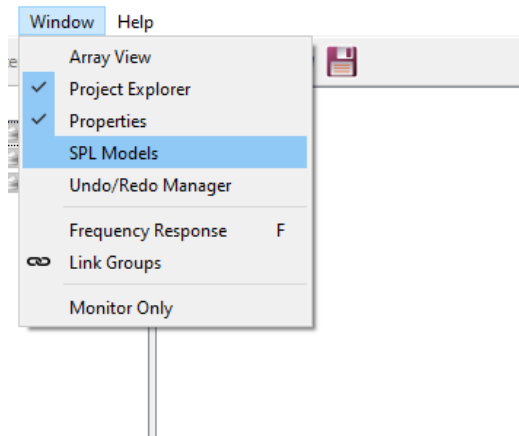

Fig 4. Open dialog for *.eawcab file

SPL Models

Open this feature using the Window pull down menu



Adding a new model

1. Right-click an array or select multiple arrays and right-click
2. Choose "Add SPL Model With" from the popup menu
3. SPL Model array group is added to SPL Models view

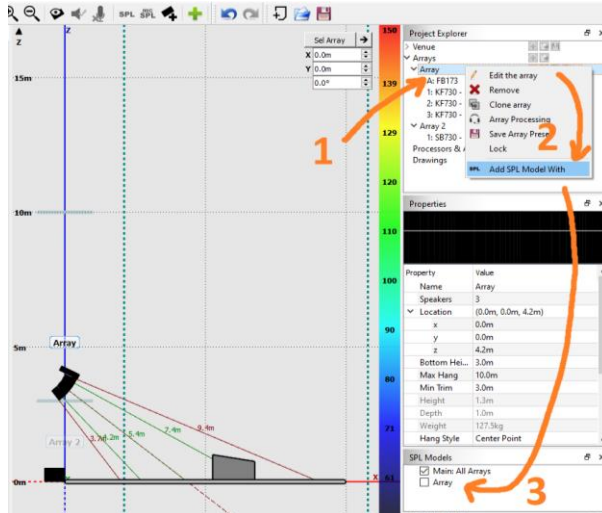

SPL Models Window

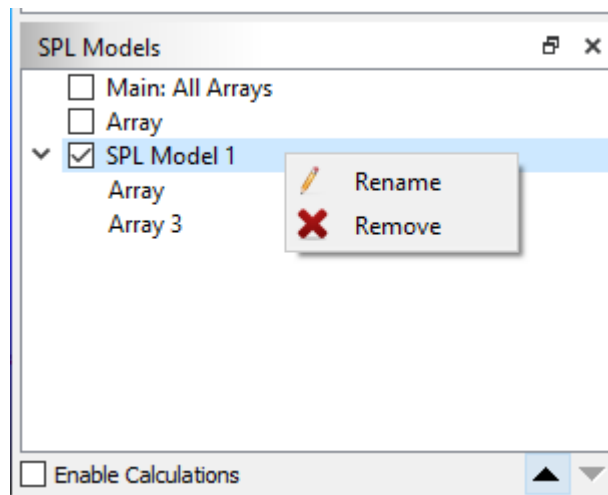

1. An SPL Model group that contains a single array (example "Array" group) is named after the array it contains. This name cannot be changed.
2. An SPL Model group that contains multiple arrays (example "SPL Model 1" group)
 - a. Is auto named "SPL Model #"
 - b. The user can **rename** by right-click popup menu "Rename"
3. The group with the check mark is the current active SPL Model for which SPL data is computed.
 - a. Switch an SPL model by checking a box, or double clicking the group
 - b. Switching SPL models will invalidate all SPL data and recomputing (if Enable Calculations is checked)
 - c. Enable Calculations checkbox is the same as Enable Calculations in the View menu
4. Groups can be **removed** by right-click popup menu "Remove"
5. Groups can be **reordered** in the list by selecting a group in the list and clicking the vertical arrow in the lower right corner of the window.
6. The special group "Main: All Arrays" ...
 - a. Cannot be removed
 - b. Cannot be renamed
 - c. Cannot be repositioned in the list, is always at the top.
 - d. This group contains all arrays, is the same as previous versions of Resolution.

Saving & Restoring

eawresolution -- SPL Models are saved in the file and restored when reloaded.

eawcab – SPL models will be saved in the eawcab file, but generated SPL will NOT be saved for any group other than the Main group. The thinking here is that:

- a. this is primarily a design team feature and not likely to be required by existing systems.

- b. Including SPL for multiple models could lead to very large eawcab files. Load times could be long. This would require some research to test and optimize.

Soloing Arrays

If a SPL Model group contains an array that is **soloed** then the array group will be labeled with an “S”

SPL (for the selected group) will be calculated with all the arrays in the group while respecting the soloing status of the members of the group.

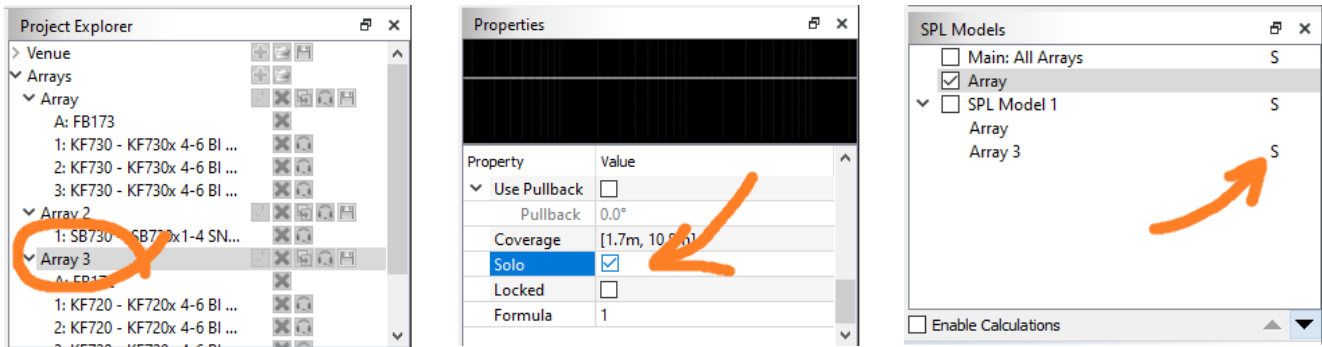

SPL Distribution Chart

The SPL Distribution Dialog shows a chart of the SPL distribution as well as statistics computed from the data. Sample data is computed from the cached SPL information for each surface. For that reason, SPL must be computed in Free View prior to opening the dialog.

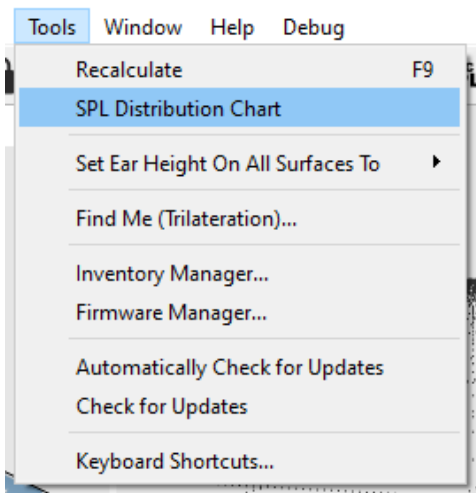

When opening the dialog from the tools menu, SPL sampling of each surface will begin. This may take some time, especially for larger venues. Once sampling is completed, a chart will be plotted and fit to the max and min non-zero samples discovered. These values will be entered into the Distribution controls.

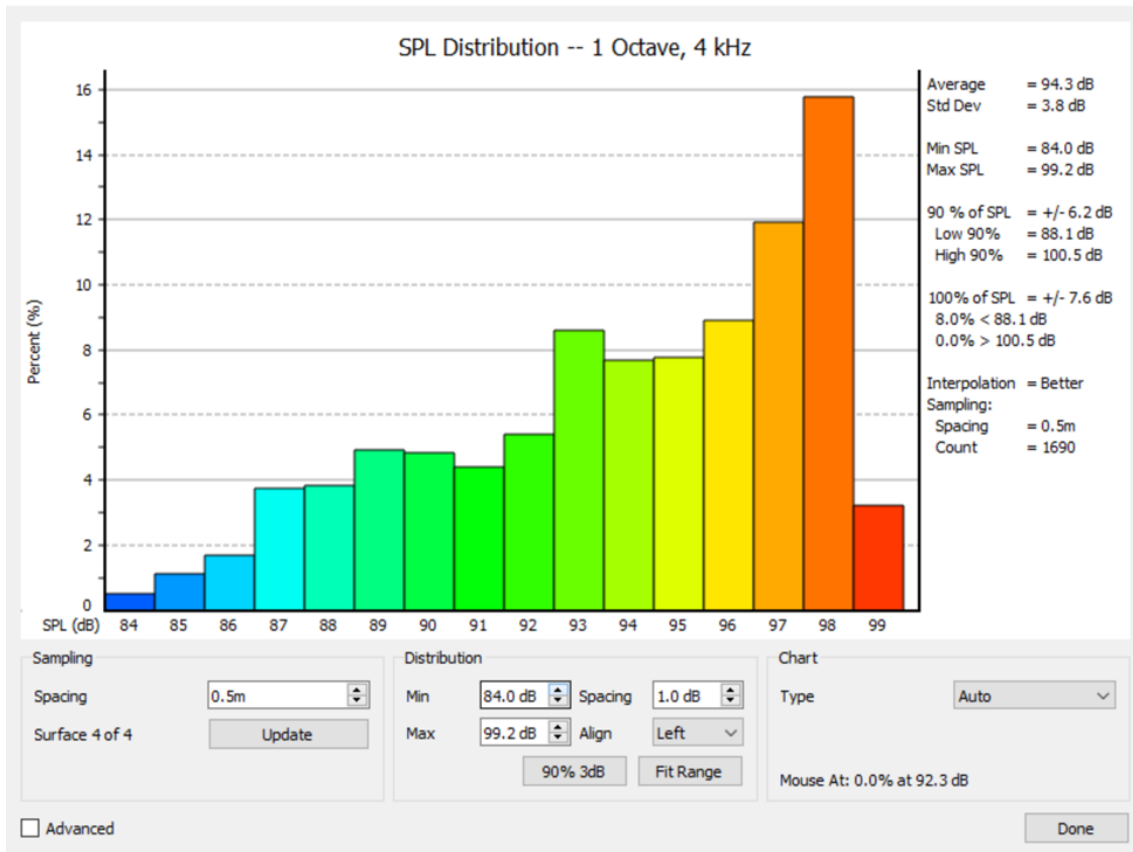

The chart title will include the current SPL octave range info while the bar chart colors will correspond to the SPL colors.

Distribution Options

- Min – minimum SPL value contributing to the chart. Lower values are thrown away.
- Max – maximum SPL value
- Spacing – the width of the bar in dB. All samples in that range are counted for the bar.
 - Example: Min=100, Spacing=1, bars will be 100,101,102,103,... where each bar contains the samples in the range (100...100.99999, 101...101.99999, etc.)
- Align – Aligns the spacing around the SPL step.
 - Center = +/- ½ of spacing – e.g. 100db bar with 1dB spacing = 99.5...100.49999
 - Left = + spacing – e.g. 100db bar with 1dB spacing = 100...100.9999
 - Right = - spacing – e.g. 100db bar with 1dB spacing = 99.0001...100
- Fit Range – analyzes the SPL data to find the min/max SPL values and enters them in the Min/Max boxes.
- 90% 3dB – analyzes the SPL data to fit the view to 90% of the samples with a 3dB spacing. The Distribution Min/Max boxes are changed to reflect this.

Sampling Options

Sampling is performed on a grid relative to the XY plane origin (0, 0). The user may specify the sample spacing, or step size. SPL samples are taken from each audience surface at an XY intersection point.

- Spacing – the distance between each sample in the X and Y directions. The actual sample spacing for the current chart is shown in the statistics section.
- Update – restart the sampling. Once sampling completes the chart is redrawn and statistics updated. Sampling can be stopped by hitting the same button (which now says Cancel). When cancelled, the current chart is not changed. However, the spacing value may not match that of the data in use.

Chart Options

- Type – the type of chart to show
 - Auto – the dialog chooses whether to show bars or lines
 - Bar – show a bar chart
 - Line – show a line chart
- Smoothing Level – smooth the line chart to show the general curve
- Show Data Points – show the data points for the line chart
- Mouse Position – show the SPL level and percentage of values for the given point where the mouse pointer is dragged to within the chart area.

Exporting the Chart

The chart can be exported by right-clicking inside the chart area and selecting Export Chart ... from the pop-up menu.

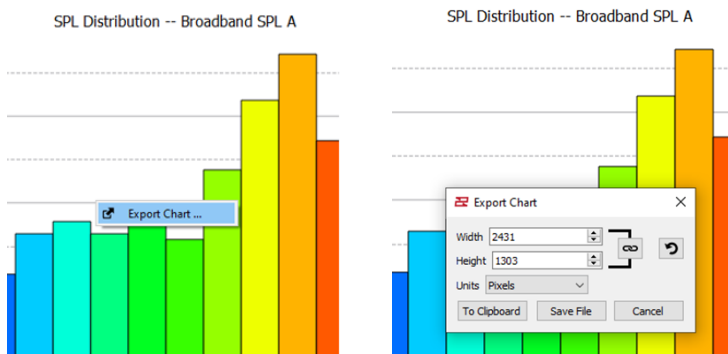

In the dialog, specify the export dimensions of the image in pixels, inches, or centimeters. Dots per inch can be set for inches or centimeters to achieve a resolution that is good enough for print. The link button will maintain the current image aspect ratio of the dimensions when one of the dimensions is changed. The reset button (counterclockwise arrow) will return the dimensions to the original values and aspect ratio.

The chart can be exported to the clipboard for pasting into other applications or can be saved to a file.

Section 6 - Working With Arrays

After audience areas are entered, the next step is to add loudspeakers to the model. This can be accomplished quickly and easily using the **Array Assistant**. The Assistant can be used to add point-source, line array or Adaptive systems to the model.

Adding an Array - Launching the Array Assistant

Upon initial start of the software, there will not be any arrays added to the model. In the **Project Explorer** window under “**Arrays**” the user can do one of the following:

- **Add Array** - This will launch the Array Assistant.
- **Load an array preset** - This is assuming that you have previously saved array files contained within the software.



When the + button is clicked in the **Project Explorer** window next to **Array**, or the “+” button on the tool bar, this will launch the **Array Assistant**.

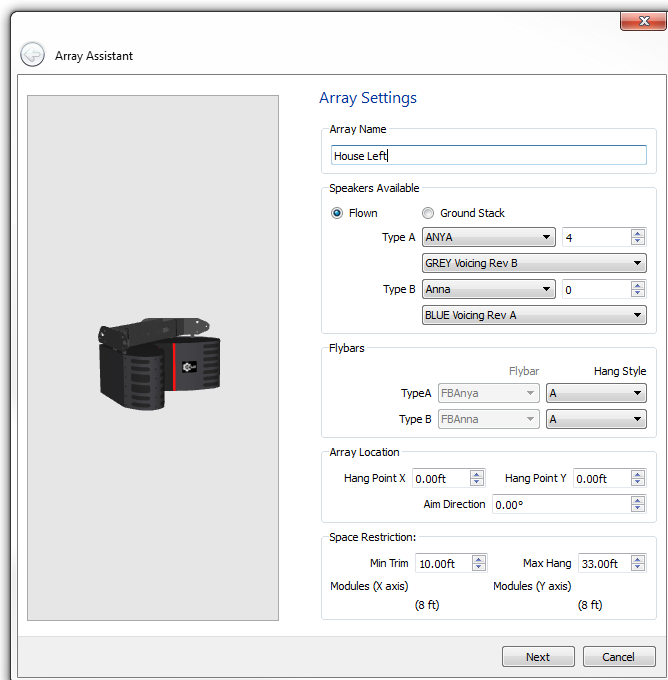

Array Settings Page

The purpose of the **Array Assistant** is to allow the complex software in Resolution to determine the proper placement and aiming of the selected loudspeaker(s) based on data inputted by the user.

Before launching the **Array Assistant**, a complete model of the venue should have already been designed.

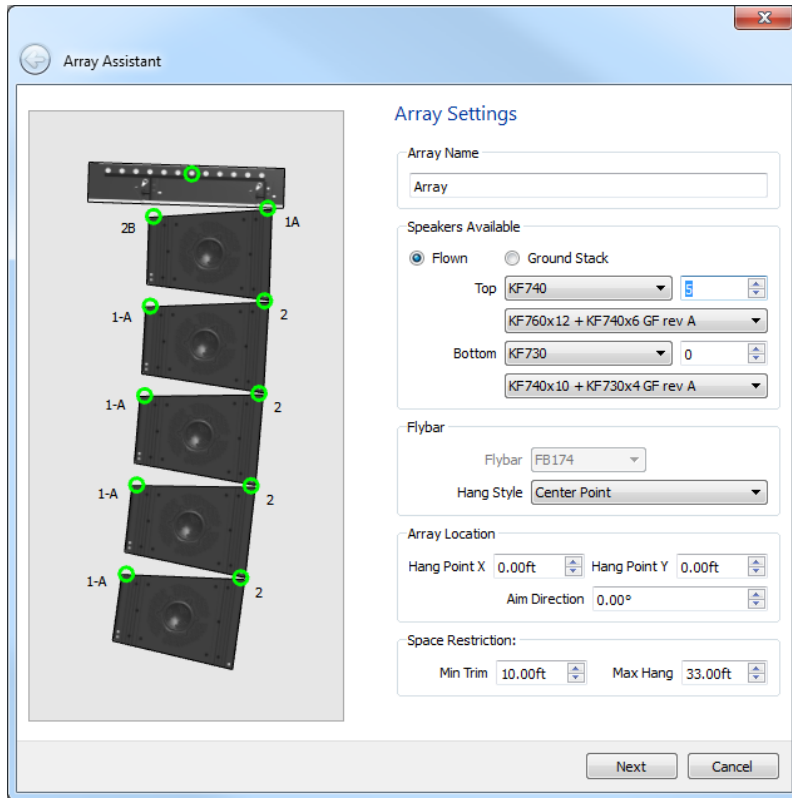

The first page of the Array Assistant allows you to give the Array a name, define the compliment of loudspeakers you intend to use and information about its physical location.

Array Name

Enter any name you wish for the array such as "Left Main", "Center Main", etc.

Loudspeakers

- Determine if the array or loudspeaker will be ground stacked or flown.
- Select the product that will be used at the top of your array from the dropdown menu labeled **Top**. Only products that have been selected in the **Inventory Manager** will be visible in this dropdown menu.
- Select how many elements of that product are available to form an Array. This is a number that the software will draw from. It is not guaranteed that the exact number will be used but the software will not use more than what you say is available.
- Select the EAW Greybox that you wish to use with this product. Some products have multiple Greyboxes available while others may have only a single selection.
- If you are building an Array with a different model loudspeaker for the lower section, then select that model from the dropdown menu labeled **Bottom**. For example, you may want to build an array with KF740s on top with KF730s on the bottom.
- Select the EAW Greybox that you wish to use with this product. Some products have multiple Greyboxes available while others may have only a single selection.

Connections

- Some combination arrays will support multiple ways to connect the Type A and Type B speakers. The Connections entry box allows selection of the different components used to join the two speaker types. For example, an NT206L on top of SB118 offers the choice of a Pole Mount, with different heights, or Sub Mount.

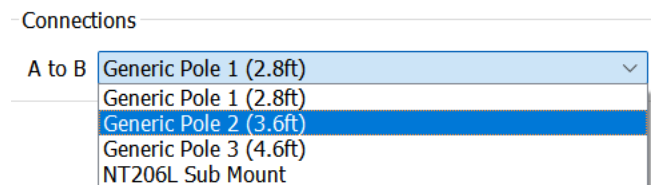

Flybar

- Some EAW products have more than one flybar available. A case for this is the KF760 which has two generations of flybars. This feature allows the user to select the flybar that they have in inventory. This is important as each flybar will produce a different set of mechanical data.
- EAW Flybars will also have a choice of hanging options. Some may have more than 3 so it is important to select what method you will use to hang your flybar.

Array Location

One final step on the first page of the array assistant will allow you to place the array within the model.

- **Hang Point X** - This allows you to place the loudspeaker or array along the X-axis of the model. Normally this value would be set to zero but not always, especially when you are building a room model that is designed in a full 360 degrees.
- **Hang Point Y** - This allows you to place the loudspeaker or array along the Y-axis of the model. When left at zero, the array will present itself in the center of the model representing a center cluster. Plus and minus measurements are used to place the array at its real separated distance.
- **Aim Direction** - If there will be a predetermined azimuth for the loudspeaker or array, enter that value here and the model will consider the aim angle when deploying the loudspeaker or array.

Space Restrictions

- **Min Trim** - To properly calculate the placement of the array, the software needs to know how low the array or loudspeaker can be suspended. The minimum trim indicates how low above the surface the loudspeakers can be suspended.
- **Max Hang** - As with minimum trim, the software also needs to know how high the loudspeaker or array can be flown. The maximum trim indicates how high above the surface the loudspeakers can be suspended.

Coverage Goals page

On this page, you will define what performance criteria you want Resolution 2 to calculate the Array configuration.

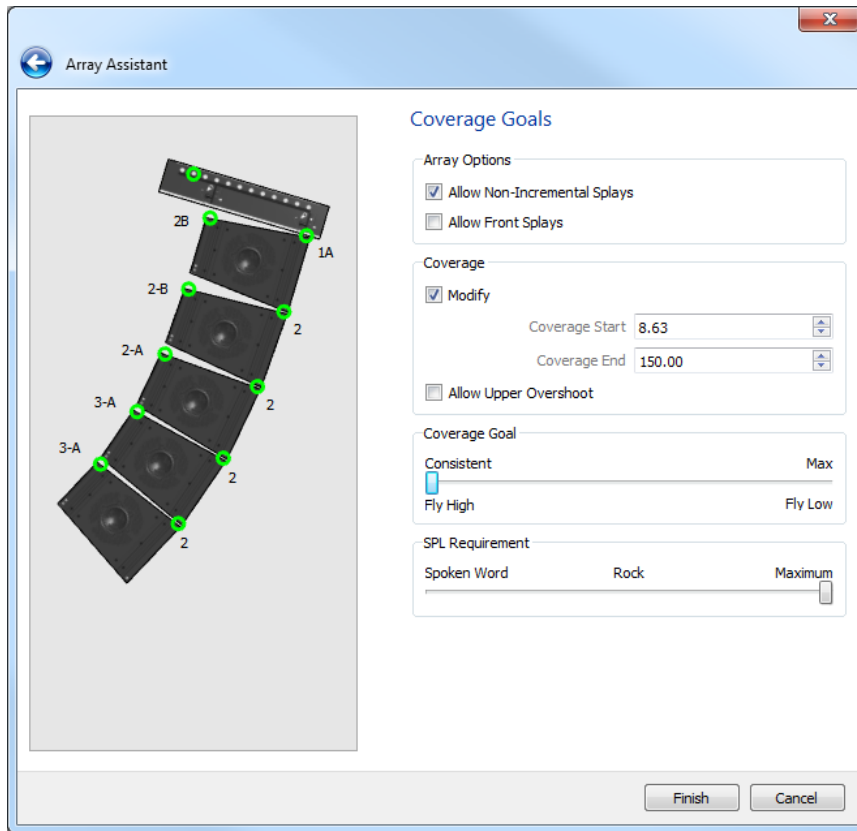

Array Options

Allow Non-Incremental Splays - You can select or deselect the use of “Non-Incremental Splays”. Some designers adhere strictly to a “spiral-array” approach of deploying line arrays. This means that the angles between enclosures will always increase from top to bottom. Others will allow the angles of the array to adapt to match the contour of the audience. If you choose to create spiral arrays, you would deselect this feature.

Allow Front Splays - Front splays may also be selected. By default, the software has this feature turned off. Opening the fronts of EAW line array enclosures is possible but not recommended. Best results are obtained when the fronts are tight together but there are occasions when “audio triage” is necessary either to cover the entire audience due to an insufficient number of enclosures on hand or to try and split an array to miss reflections from a balcony face, etc.

Coverage

By default, Resolution uses the extremities of the listening area to determine coverage. However, there may be occasions when the entire venue may not need to be covered. Using the Coverage section, you may create a new listening area within the model without having to redesign the surfaces. Coverage is indicated within the model as a blue arc drawn on the X-Y plane.

Modify Coverage

- Check the **Modify Coverage** box to open the feature.
- Enter in the closest distance to the origin that you are trying to achieve coverage. The software will cover as closely as possible to your desired coverage request.
- Enter in the farthest distance from the origin that you are trying to cover.

Allow Upper Overshoot - By default, Resolution uses the extremities of the enclosure coverage to determine the end of coverage. These are also known as the “soft edges” of the coverage angle and although frequency response is still nominal in this region, the SPL will have dropped on average 6dB. Allowing the software to overshoot means the top of coverage is biased towards more “on-axis” response from the loudspeaker and the loudspeaker or array will point higher than the top of its coverage limit. The advantage to this is more SPL delivered to the back of the venue.

Coverage Goal

The first slider named **Coverage Goal** effectively controls the trim height of the loudspeaker or array. By flying higher and tilting down more, we can provide a more even coverage of the SPL front to back of the venue. This is not always desirable as it does raise the array away from the front of the audience. Certain types of music such as heavy metal may actually prefer to have the array quite loud at the front. This feature is limited by the available height in the venue.

SPL Requirement - The **SPL Requirement** slider can be used to define how many enclosures the software will pull to create an array (no more than what you entered as the max available). With the slider all the way left to “spoken word”, the software will pull the fewest modules possible to cover the audience area. If the slider is pulled full right to maximum, the software will pull all available enclosures as you had defined on the previous panel, maximizing SPL for that particular audience configuration.

At this point, you can click the **Finish** button and allow Resolution to calculate the best possible placement and deployment of your loudspeaker or arrays. You may also click back arrow button in the top left corner to make edits to your arrays or click the **Cancel** button to abort the process and begin again.

Modifying an Array via the Array Assistant

The process for modifying an array is identical to that of adding a new array, except that the Assistant auto-populates with the current settings of the array you are editing.

Differences between Traditional Line Arrays and Anya/Anna Arrays in the Assistant

When Anya/Anna is selected as the loudspeaker type, the **Coverage Goals** dialogue is

slightly different than with a mechanically-articulated line array. **Array Options** and **Coverage** are replaced with just **Coverage**. The user is able to define a horizontal coverage angle requirement, as well as “coverage start” and “coverage stop” distances (along the X-Y plane) for each column.

Options

Columns driven uniformly - Selecting **Columns driven uniformly** will configure the system to provide the maximum output from all columns. This option should be selected if maximum SPL is desired at the cost of consistency over the audience surfaces.

Columns driven Adaptively - Selecting **Columns driven Adaptively** will adjust the relative level between columns in the arrays in order to provide the most consistent SPL levels at the audience surface. This option should be used by default and will provide the most consistent SPL over the audience area.

Tilt – This checkbox only applies when using AC6 column arrays. If the intent is to use AC6 either tilted up or down, this box must be enabled before proceeding.

Air Loss Compensation

There are four Air Loss Compensation presets available that can be chosen from the Array Assistant when working with Adaptive arrays. Air Loss Compensation is explained in-depth below in the Air Loss Compensation section.

The **Coverage Goal** and **SPL Requirement** sliders function as they do with other arrays.

Optimizing Radius Line Arrays in Resolution 2.9 and up

Go online with the system

- Click on Network > Connect

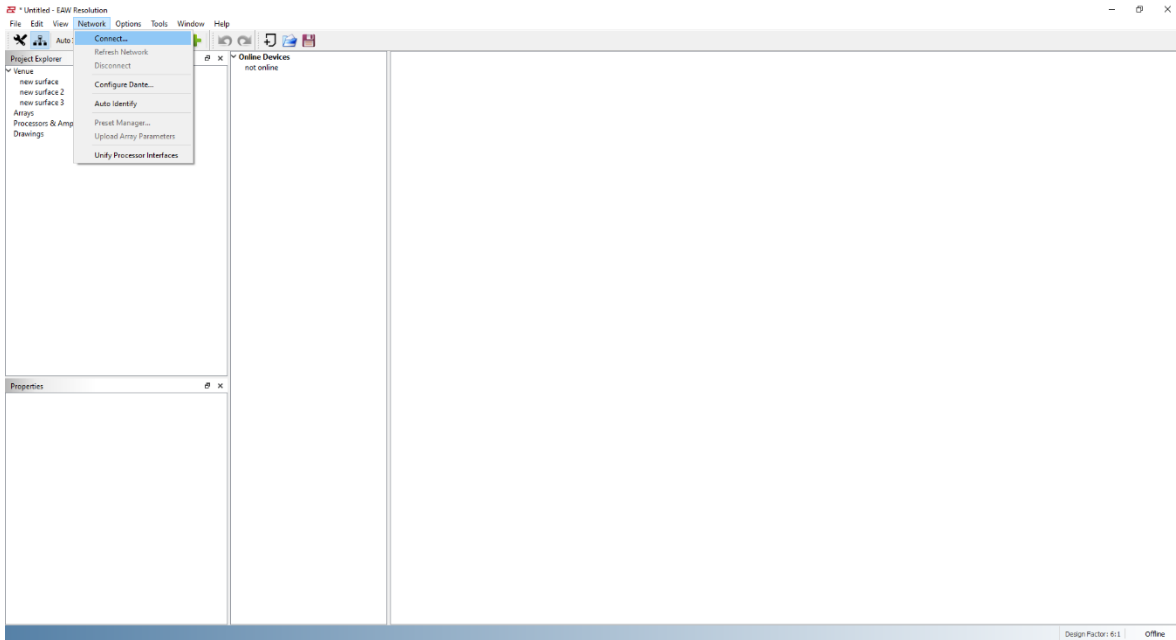

All devices will appear under **Online Devices**

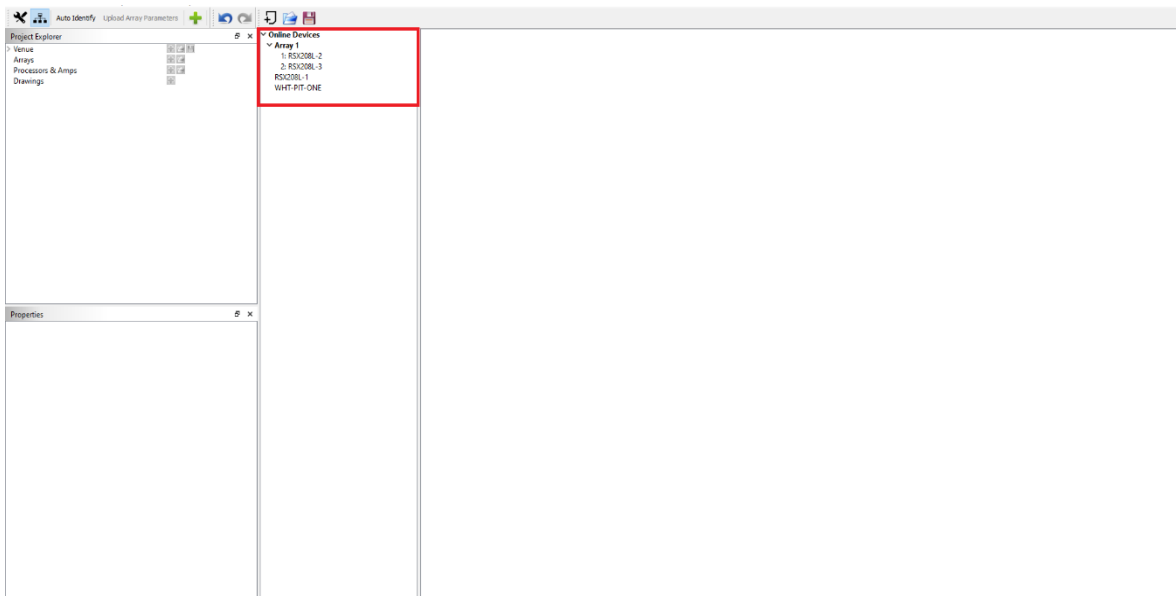

Click and drag on arrays or devices to create an array

- Choose Ground stacked or Flown
- An array will automatically create and appear in the right window pane

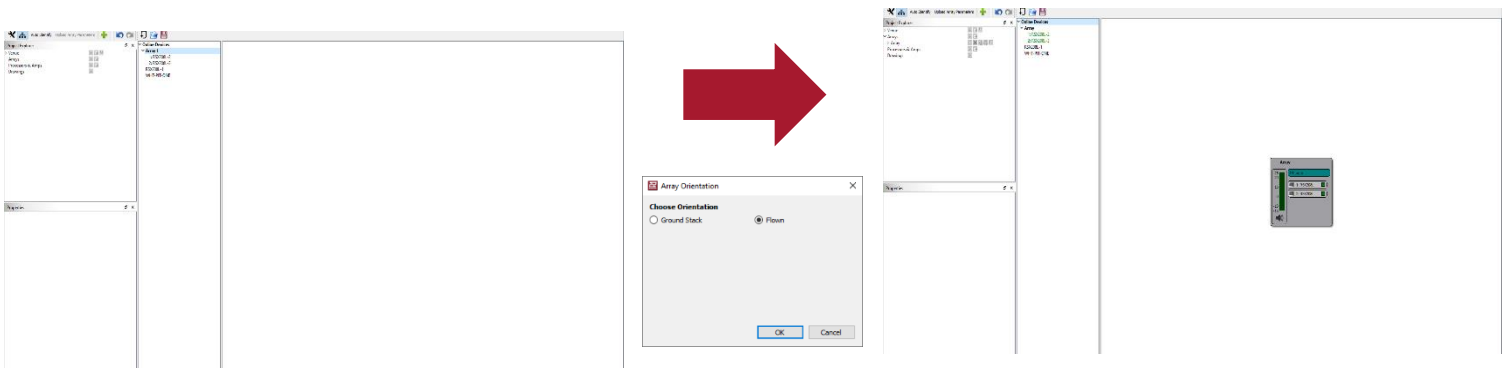

If an IR sensor is not working, it's possible to manually add an array item, then click and drag the "fragmented" online device to assign.

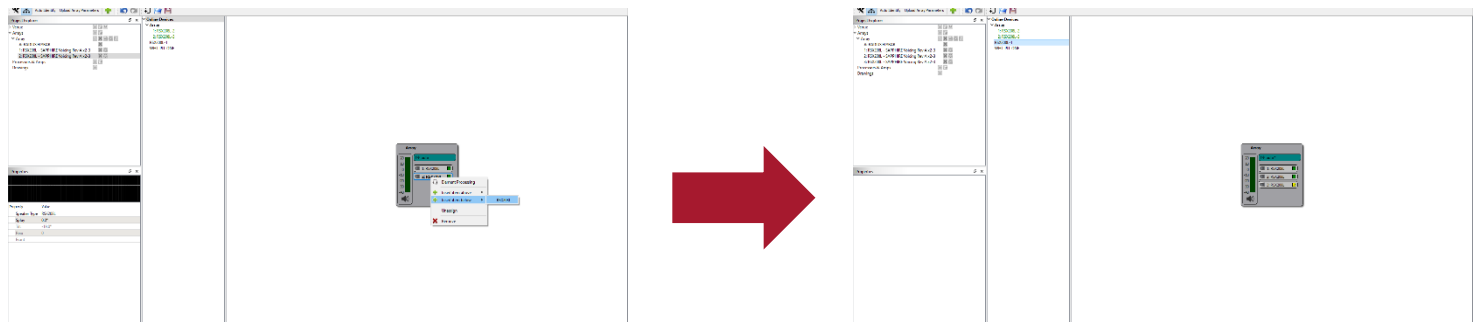

The green indicators verify that the array is now operating as expected and ready to use

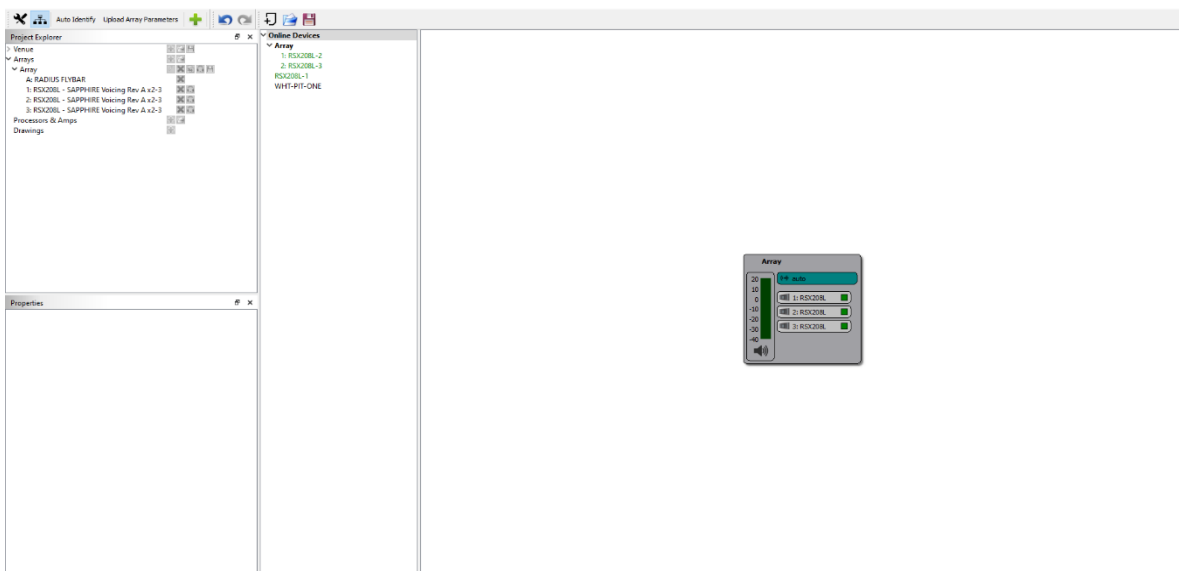

Select the array then double click on the EQ/DSP under **Properties**

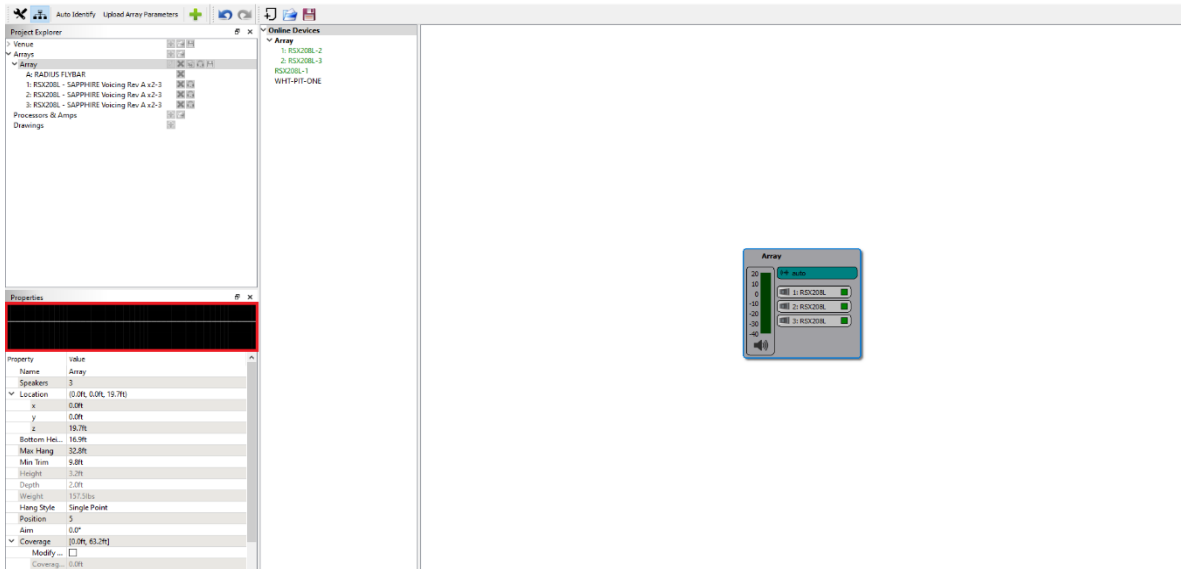

Check Optimize Options

- Array Length Compensation: LF Coupling
- Air Loss Compensation: HF Shading

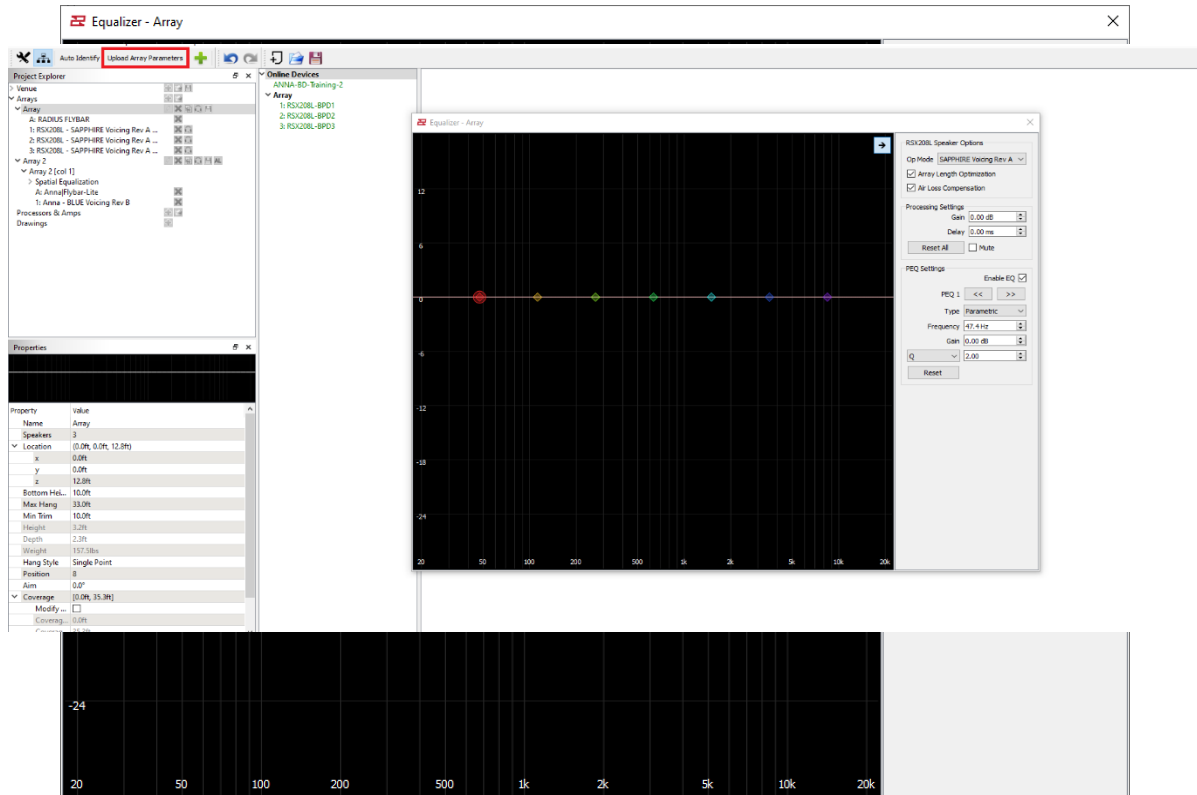

Then click Upload Array Parameters

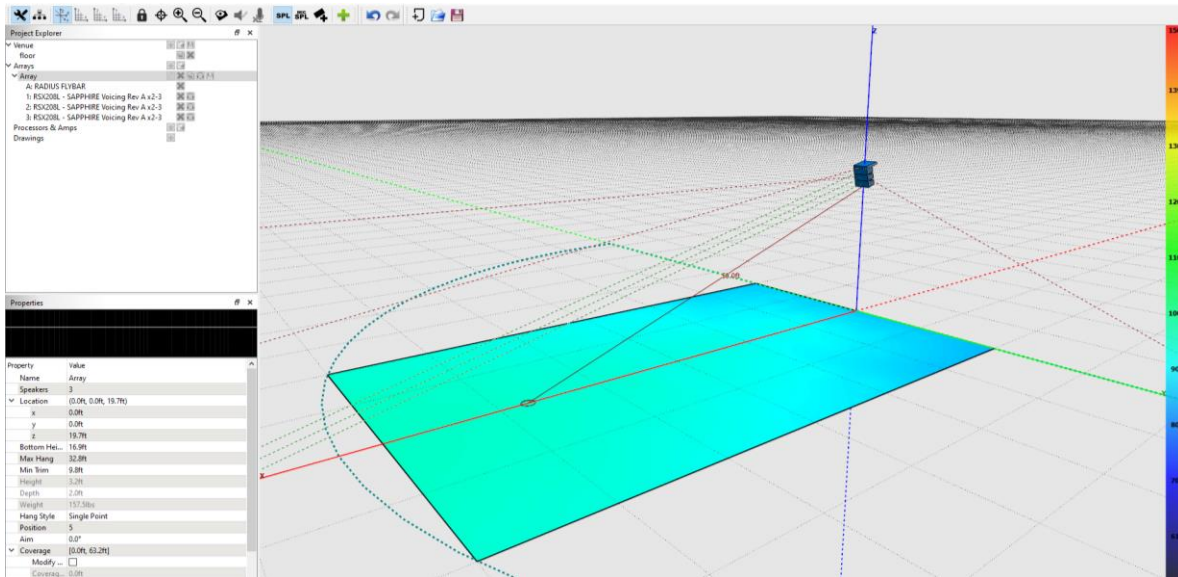

When each module status is synchronized, the system is now optimized and ready to use

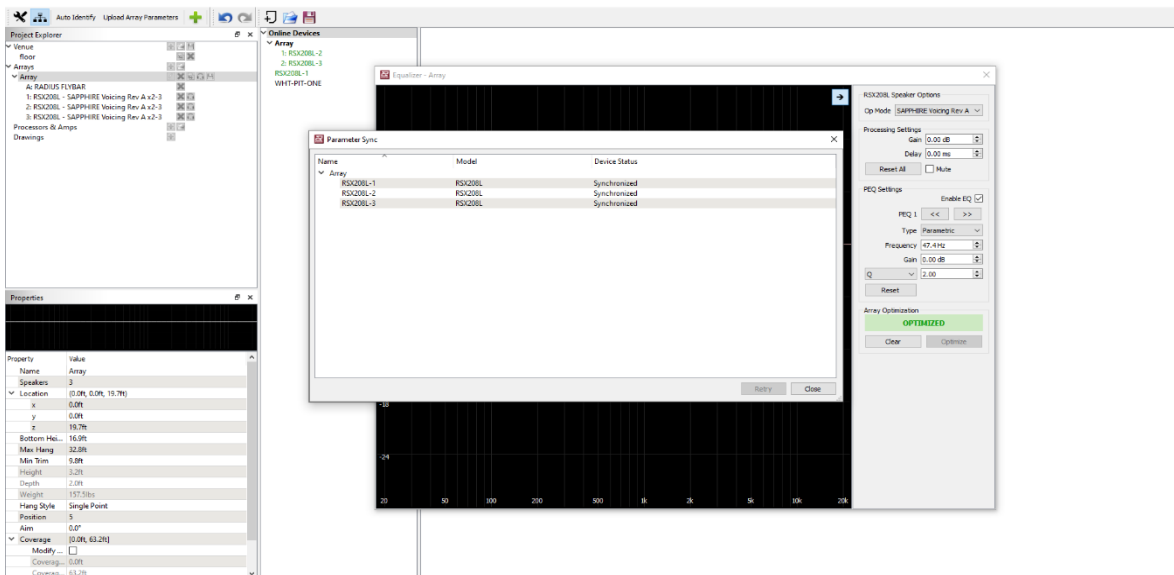

Resolution uses the venue model and array configuration (array size, height, and position) to determine optimization.

Cardioid Arrays with RSK18F & SBX118F Subwoofers

Resolution can detect each subwoofers position in the array (facing forward or facing backward). The orientation will read from the topmost speaker in a flown array or bottom most speaker in a ground stacked array. When going online with a subwoofer array, the

orientation direction may be set in the software.

It is possible to go online with the subwoofer array utilizing two methods. The first would be to take an online array and click and drag it into the system. All detected subwoofers should populate under an associated array menu as shown below.

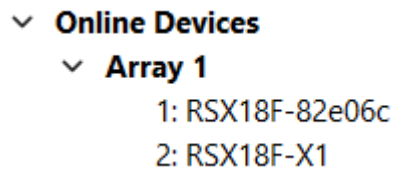

Click on the array and drag it into the current system. A prompt will appear requiring information on the physical array. The details will change depending on the orientation chosen.

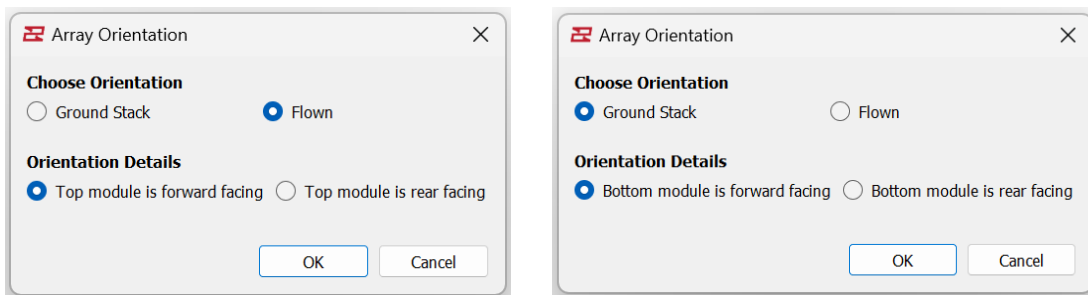

NOTE: Other RSX and SBX series subwoofers will generate the same prompt when dragging an array into the system. In these cases, communication module to module is not occurring through the IR sensors, and since flowed is not an option, this variation of Array Orientation will be shown.

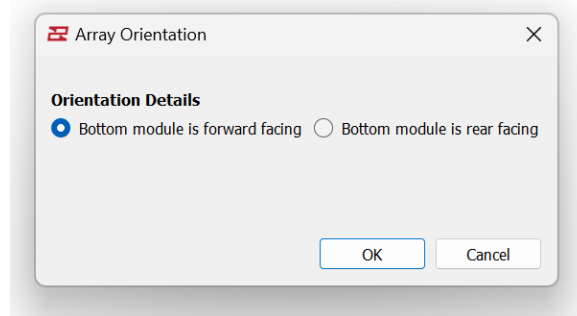

With the array now loaded into the system, it is possible to select each cabinet in the array and determine its cardioid position.

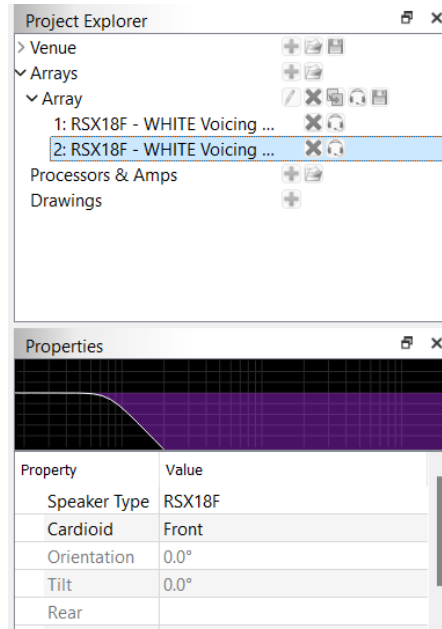

Any changes to physical subwoofer cardioid position or parameters in Resolution will require a refresh of the network and an upload of the current parameters.

The second method would be to design the cardioid subwoofer array in Resolution, then assign the online array. The physical configuration will need to match the system design exactly, or it will not allow the online devices to be added to the array.

Start by adding the subwoofer array using Array Assistant. Note here it is possible to rotate the array 180 degrees when ground stacked (not an option for flown)

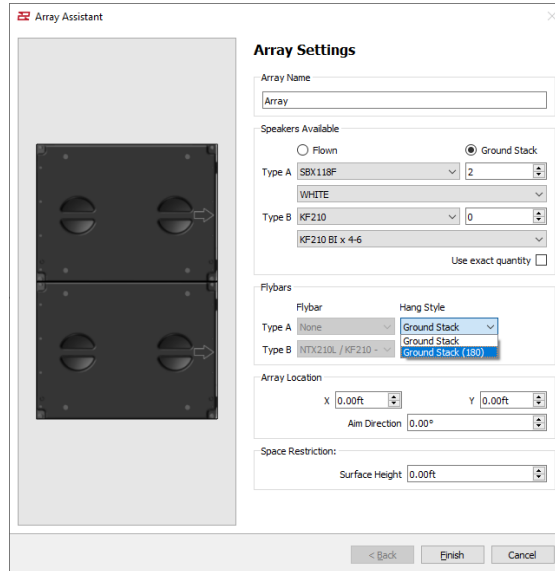

Once loaded into the system, choose which subwoofer should be reversed to accomplish the cardioid array. This can be done by selecting the subwoofer cabinet under the array in Project Explorer, then changing the value under Cardioid in Properties. It is also possible to modify the orientation as well.

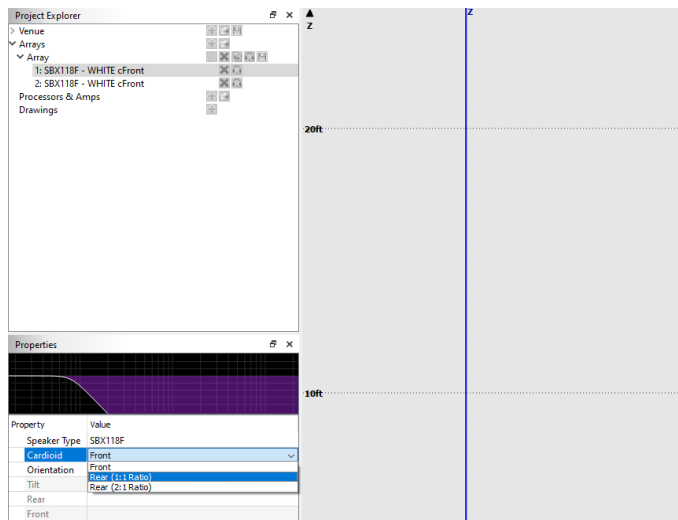

Under Network Configuration View, the array just added will show in the system.

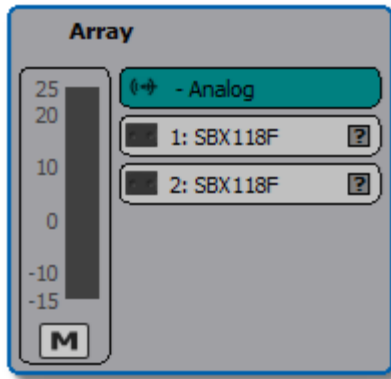

Take the array populated under online devices and click, drag and release it on top of the designed cardioid array. As mentioned, if the configuration of the physical array matches that of the designed array, the assignment will go live. Any changes to the array from this point will require an upload of array parameters in Resolution.

Working with Anya and Anna in the Model

The 'Project Explorer' and 'Properties' windows for Anya and Anna are unique in that they includes several unique user-adjustable parameters that aren't available for non-Adaptive arrays.

Coverage – By default coverage is defined when the array is created in the Array Assistant, but it can be adjusted manually after the array has been added to the model. This is done by selecting a column within an Adaptive array and selecting the box for 'Modify Coverage'. Once the box is checked the user can adjust start/end coverage points two ways: by clicking and dragging the coverage lines within the model, or by manually entering start/end values in the 'Properties' window.

Override Z Bounds – This feature allows the user to exclude portions of the audience that overlap in the 'z' plane. Selecting a lower bound (Start Z) and upper bound (End Z) will inform the Adaptive arrays to only consider audience surfaces within those 'z' bounds. For example, in a venue with a balcony where coverage was only desired for the under-balcony seating, appropriate 'z' bounds could be set so the upper 'z' limit was below the balcony seating. This would direct the arrays to cover the under-balcony seating and not provide coverage for the balcony.

Extend Coverage - This checkbox gives the user the option to extend coverage beyond where audience surfaces are defined in the model. If this box is not checked only audience surfaces that are within a column's coverage pattern, and not excluded by 'z' bounds, will be considered when the column is determining its vertical coverage pattern. If the box is checked, the nearest and furthest surfaces will be 'virtually extended' to the bounds of chosen by the start/end coverage of the column.

For example, if an audience surface ends 50' from an array column, but the end point of the column's coverage is set to 75', if the 'extend coverage' box is checked the array

will produce a vertical coverage pattern as if the surface actually extended to 75' (or whatever the end coverage distance was for the column). If the box is unchecked the array will produce vertical coverage for the surface that is 50' long, regardless of where the start/end points of its coverage are.

Spatial EQ

Spatial EQ is a feature unique to Anya and Anna that allows the user to implement EQ settings for specific portions of the audience area. The user selects an array, or column of an array, specifies what portion of the listening area within that column's coverage they wish to apply EQ, and enters the desired EQ. The software will then automatically assign the necessary processing for the appropriate cells in the column to realize the EQ change specified at that particular listening area.

Up to four filters can be implemented on any array or column. This can be a single filter applied to four different audience areas, four filters applied to a single audience area, or any combination.

To use Spatial EQ, select the column you wish to use in the Project Explorer window, then select the arrow adjacent to 'Spatial Equalization' to view the four zones available.

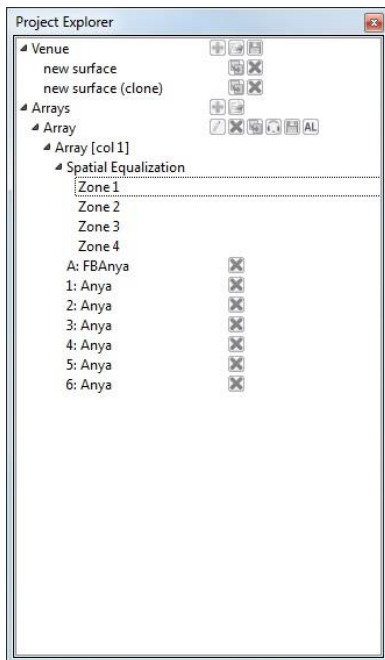

Selecting a zone will display its start and end points within the column's coverage in the model. These points can be adjusted with the mouse by selecting and dragging the start/end of the coverage lines, or by manually entering values in the 'Properties' window. This is the same process as adjusting array coverage for Adaptive columns.

The solid colored lines in the design window show the start/end points selected by the user. The dotted lines show the actual area the filter will affect. The geometry of the room, column height, column length, relative position of the zone to the column, and

the filter frequency all affect how large or small of an audience 'slice' can be isolated. The dotted lines show this to the user. Choosing a higher filter center frequency or increasing array length will allow you to isolate smaller portions of the audience.

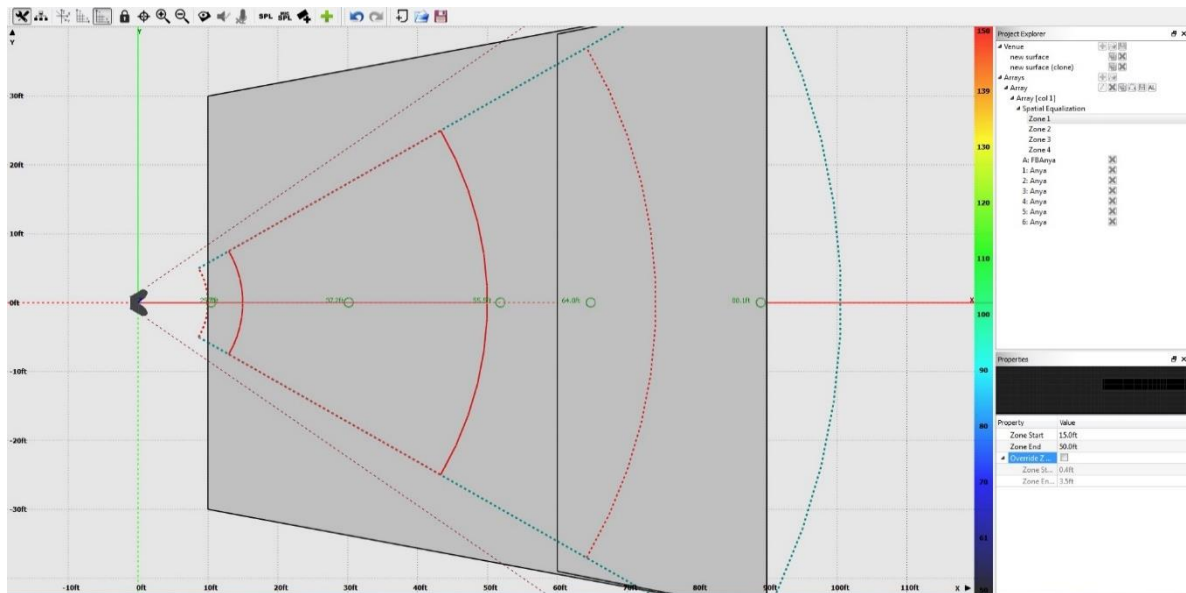

The 'Override Z Bounds' feature allows the user to limit where EQ changes will be realized in the 'z' plane. For example, if the user wants to EQ a section of the audience underneath a balcony, but not the balcony seating, the user would set the 'z' bounds to exclude the balcony audience area.

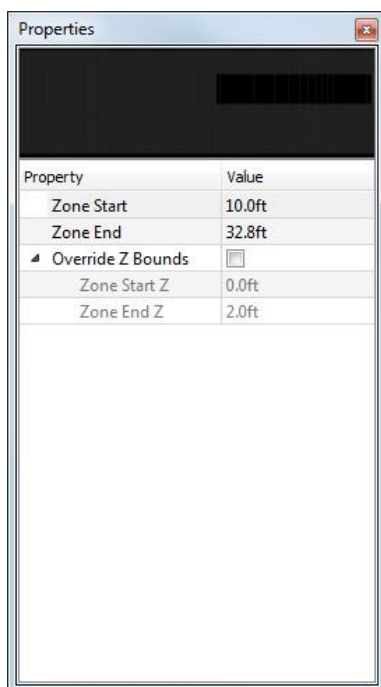

To enter Spatial EQ settings, use your mouse to select the frequency response plot in the 'Properties' menu. This will open the 'Spatial Equalizer' window. From here the desired EQ can be entered in the same way it would be for the entire array.

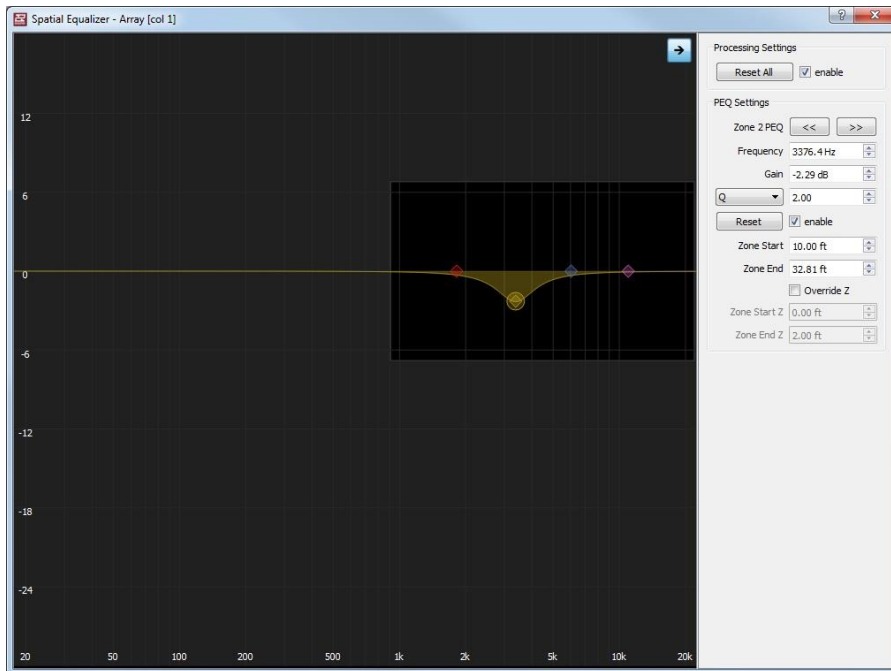

You'll notice that filters are only available above 1 kHz, this is the lowest practical frequency that allows filters to be isolated to specific portions of the audience area. Start/end points and z override selections can also be made from this control window.

Once the user has selected a zone and entered the equalization parameters the change will be live. If online with a system the equalization will be applied to the output of the system. No parameters upload or additional calculations are necessary.

More details about Spatial EQ can be found in our [technical paper](#), and our [tutorial video](#).

Air Loss Compensation and Adaptive Arrays

As mentioned earlier when working with Adaptive arrays in the Array Assistant, there are parameters available to adjust air-loss pre-emphasis filters when working with Adaptive arrays. They can be accessed by selecting the 'AL' (air loss) button for an array in the 'Project Explorer' window.

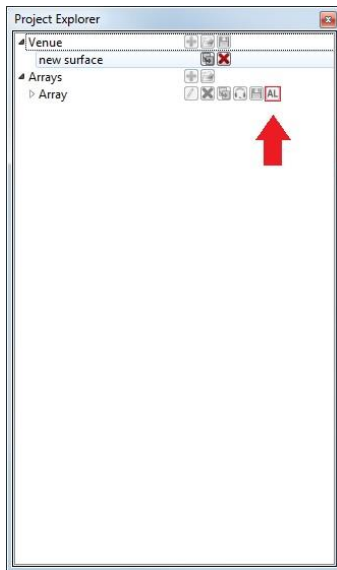

This opens the control window for Air Loss Compensation.

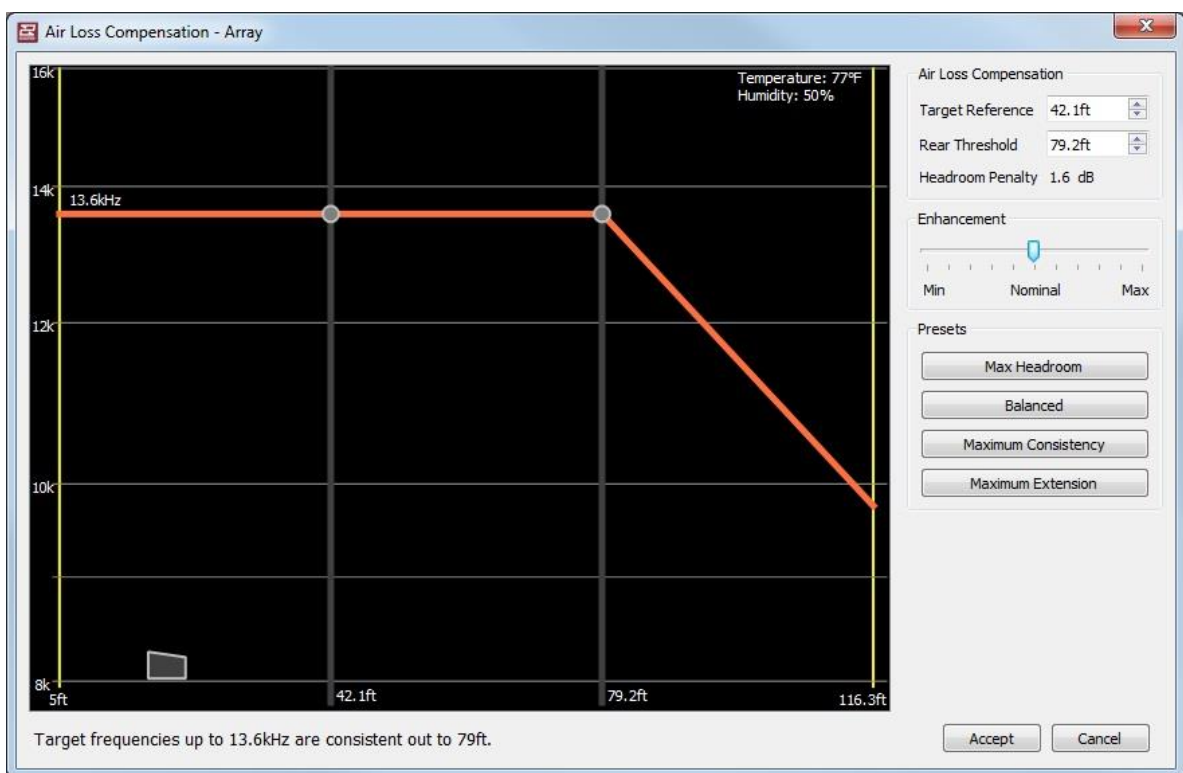

There are two points in the plot of the control window. The point on the left indicates the target reference, or the point in the audience that will be used as reference for high frequency extension. The closer to the array the reference point, the higher in frequency that extension is possible (less distance means less air absorption).

The point on the right, the rear threshold, indicates to what distance that extension will be maintained. In the image above the reference point is chosen at 42.1 feet, which corresponds to 13.6 kHz. The second point indicates that this extension will be

maintained up to 79.2 feet from the array before high frequencies begin to roll off in a way that conserves headroom.

Once a reference point is chosen adjusting the rear threshold will impact the amount of headroom available. Pushing the rear threshold back further from the array will increase the headroom penalty (how much headroom is lost), and vice versa. This value will change in real-time as the user adjusts the positions of the target reference and rear threshold, informing them to the trade-offs in headroom vs. high frequency extension.

The 'Enhancement' slider allows the user to increase or decrease the amount of extension in an absolute manner. Moving the slider to 'max' will increase high frequency extension, moving it to 'min' will decrease extension. These adjustments will be made in addition to whatever extension settings are already in place via the target reference and rear threshold positions. This slider serves as a great tool to be used in situ when a quick change to extension is needed.

'Preset' selections give the user different default starting points for determining high frequency extension. These are also the same presets that are available in the Array Assistant window when initially creating an Adaptive array.

- **Max Headroom:** This preset sets the target reference and the rear threshold points at the start point of the array coverage. Because the rear threshold does not extend beyond the reference the absolute minimum amount of high frequency extension is required. This setting produces the smallest headroom penalty possible.
- **Balanced:** This is the default setting. As the name implies this setting provides a reasonable balance between extension and headroom.
- **Maximum Consistency:** This setting produces the most consistent high frequency response possible across the entire coverage area. The rear threshold will be the end point of array coverage, and the necessary balance between the target reference and headroom penalty will be implemented to keep high frequency response consistent.
- **Maximum Extension:** This setting uses a target reference at the start point of array coverage, and maintains that extension to the end point of coverage. The trade-off here is this setting will incur the largest headroom penalty possible.

Additional details on air loss compensation in our [tutorial video](#).

Working with Otto in the Array Assistant

When Otto is selected as the loudspeaker type, the **Array Settings** dialogues are slightly different than with a mechanically-articulated line array or Anya/Anna.

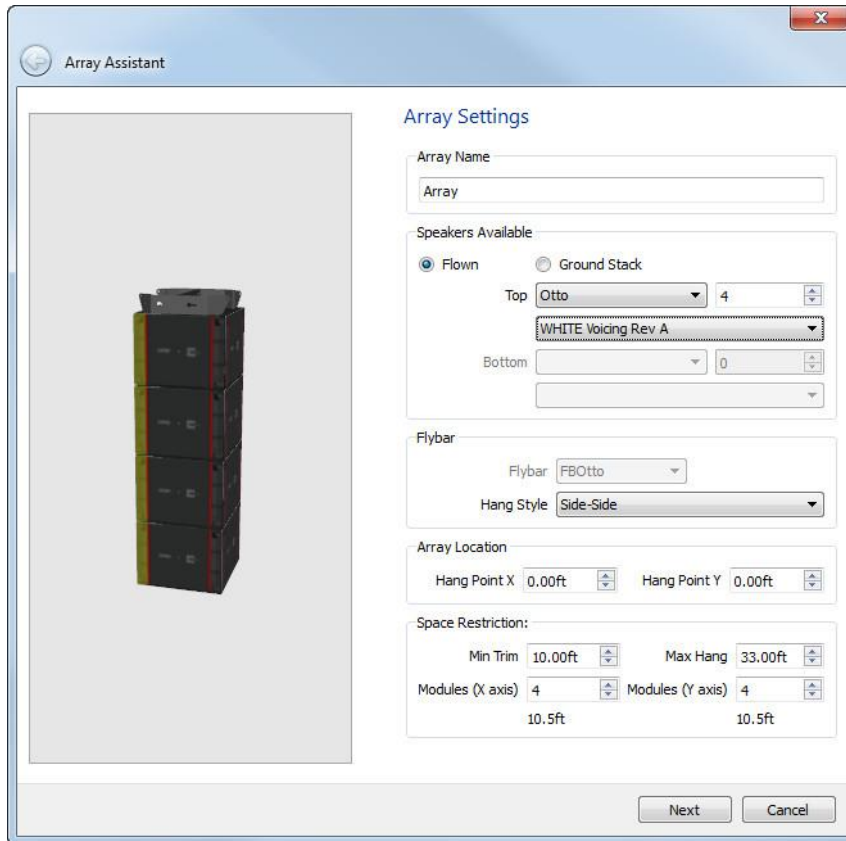

Space Restrictions

Min Trim - To properly calculate the placement of the array, the software needs to know how low the array or loudspeaker can be suspended. The minimum trim indicates how low above the surface the loudspeakers can be suspended.

Max Hang - As with minimum trim, the software also needs to know how high the loudspeaker or array can be flown. The maximum hang indicates how high above the surface the loudspeakers can be suspended.

Modules (X axis) - To provide a solution which fits within a given space, Modules (X axis) allows users to enter the number of modules which fit in the X axis, or how many modules deep the array can be.

Modules (Y axis) – As with the Modules (X axis) dialogue, Modules (Y axis) allows users to enter the number of modules which fit in the Y axis, or how many modules wide the array can be.

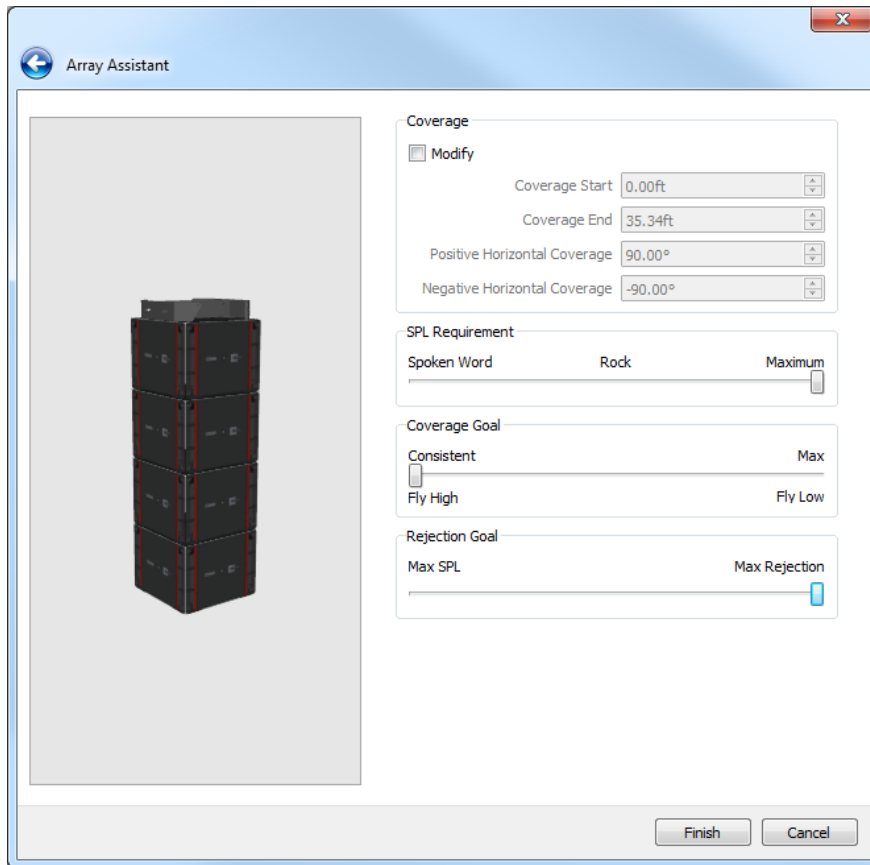

Rejection Goal

On the second page of the Array Assistant for Otto, the 'Coverage Goal' and 'SPL Requirement' sliders function as they do with all other arrays. A third slider has been added which allows the user to input a desired 'Rejection Goal'. The 'Rejection Goal' slider allows the user to choose 'Max SPL', 'Max Rejection' or points in between to achieve an appropriate balance between rejection and SPL depending on the application.

Max SPL - Selecting 'Max SPL' will configure Otto to provide the maximum possible SPL over the user defined audience surfaces, or defined coverage areas in the Resolution model.

Max Rejection - Selecting 'Max Rejection' will configure Otto to reject energy outside of the user defined audience surfaces, or defined coverage areas in the Resolution model. Maximum Rejection by default is opposite the primary coverage areas.

Working with Otto in the Properties Window

The properties window for Otto is unique in that it includes a 'Rejection Goal' drop down menu. The Rejection Goal percentage mirrors the functionality of the rejection goal slider found on the Array Assistant page. Max SPL corresponds to a rejection goal of 0% whereas Max Rejection corresponds to a rejection goal of 100%. Selecting values of 25% and 50% and 75% allow the user to select a balance between Max SPL and Max Rejection according to the needs of the given application.

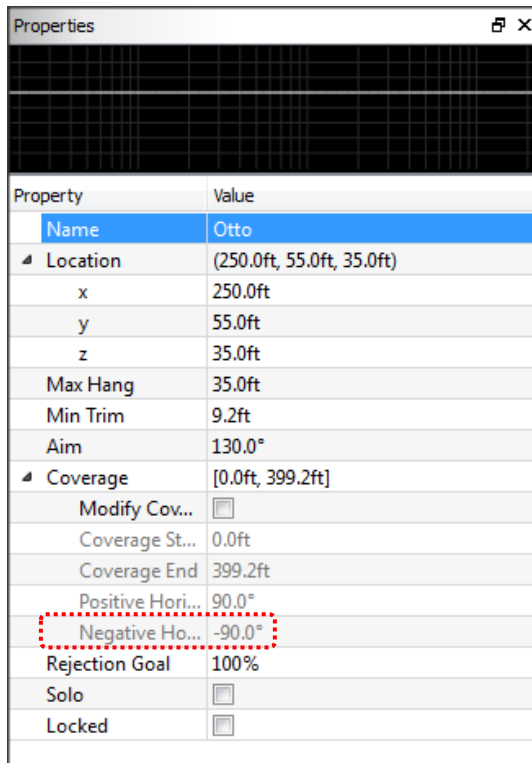

Property	Value
Name	Otto
Location	(250.0ft, 55.0ft, 35.0ft)
x	250.0ft
y	55.0ft
z	35.0ft
Max Hang	35.0ft
Min Trim	9.2ft
Aim	130.0°
Coverage	[0.0ft, 399.2ft]
Modify Cov...	<input type="checkbox"/>
Coverage St...	0.0ft
Coverage End	399.2ft
Positive Hori...	90.0°
Negative Ho...	-90.0°
Rejection Goal	100%
Solo	<input type="checkbox"/>
Locked	<input type="checkbox"/>

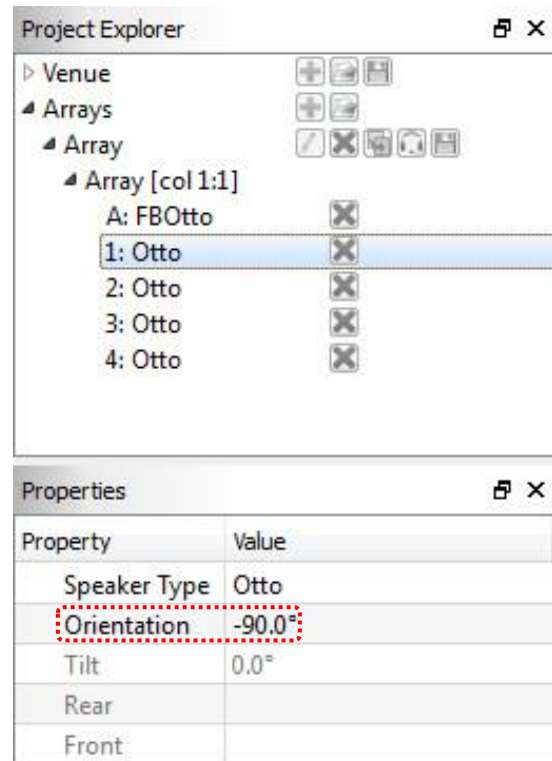

Property	Value
Speaker Type	Otto
Orientation	-90.0°
Tilt	0.0°
Rear	
Front	

Orientation - Selecting an individual Otto module in the 'Project Explorer' will open a 'Properties' menu unique to the module selected. From this properties menu the orientation of individual Otto modules can be rotated 90°. This allows the user to prevent driver apertures from being blocked in certain array configurations.

Working with Otto in the Array View Window

The Array View window for Otto allows the placement of additional columns by right clicking on a module and using the **Insert Column** dialogue box.

Ground Stacked Otto Arrays

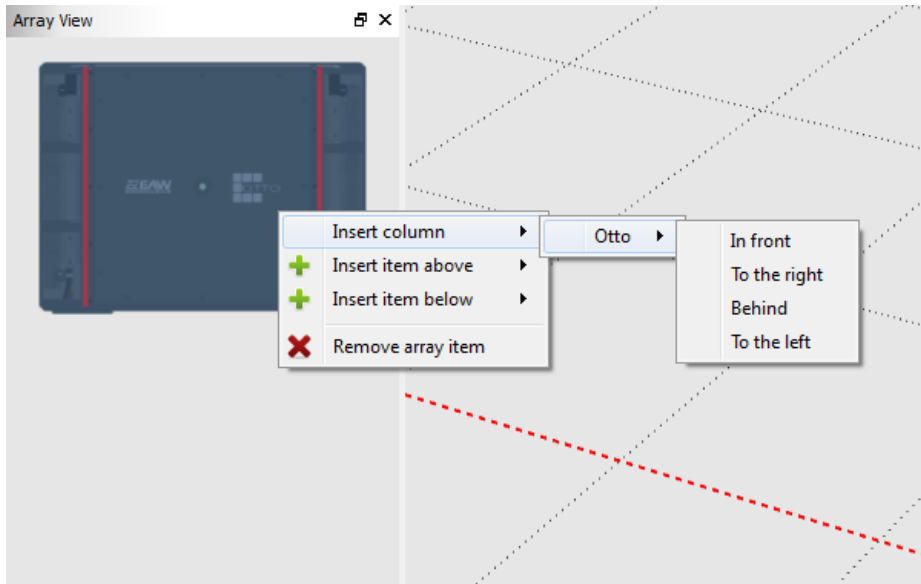

Flown Otto Arrays

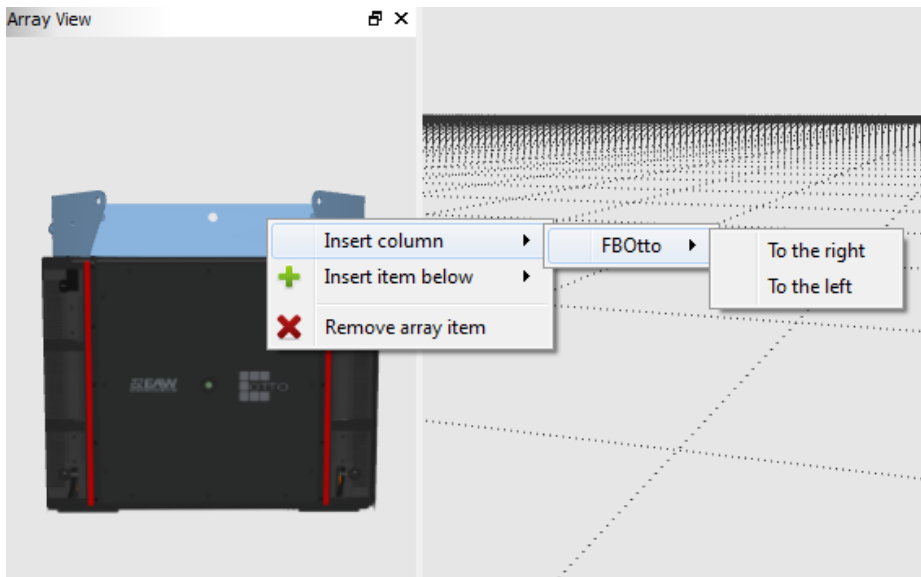

Insert column - As with other arrays, items can be inserted above and below existing array items by right clicking on them in the Array View, or in the perspective view. Unique to Otto is the ability to add elements to the right or left of the array when using a flown array. When Otto is being ground stacked, additional modules can be added in front or behind of the selected array.

Going Online With Otto

When going online with Otto, Resolution presents the user with an Array Orientation prompt. This window asks the necessary questions to determine how the Otto array is physically oriented with respect to the audience surfaces defined in the Resolution model.

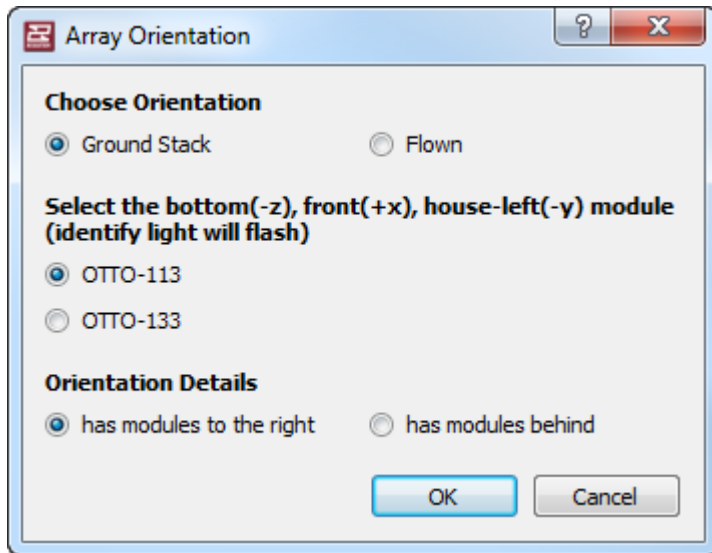

Choose Orientation – Select the orientation based on how the arrays are positioned, either Ground Stack or Flown.

Select The Bottom, Front, House Left Module - From the perspective of the audience, Resolution requires that the bottom (-z), front (+x), house left (-y) model is selected. The LED's on the modules will illuminate when selected in this dialogue to make the easier to recognize.

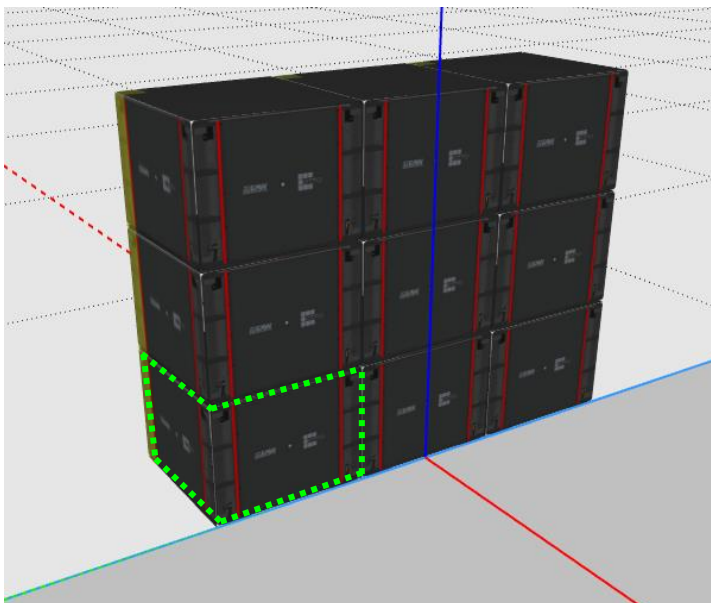

Orientation Details – The orientation details dialogue will determine how the array as a whole is oriented, using the bottom, front, house left module as a reference.

Has modules to the right will orient the array such that other modules in the array are placed to the right of the bottom, front, house left module, or along the (y) axis.

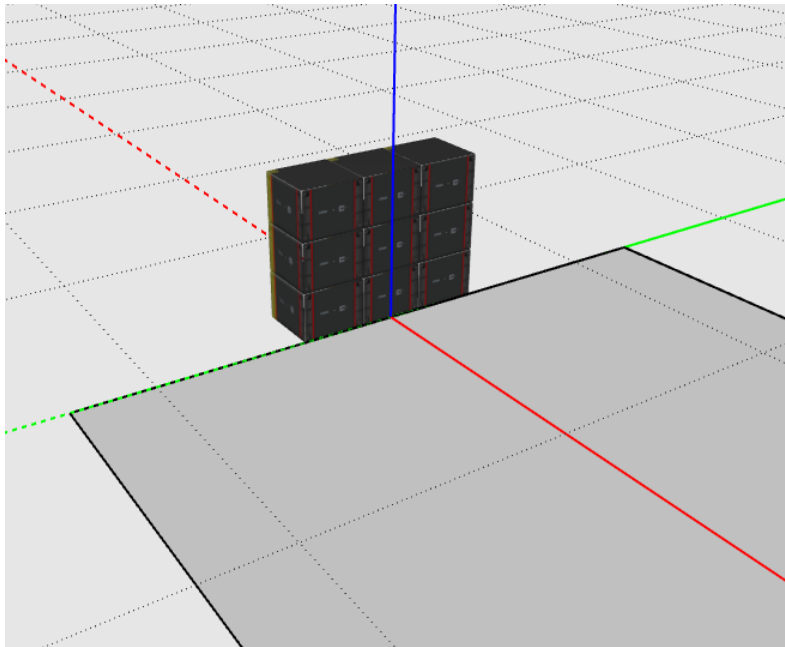

Has modules behind will orient the array such that other modules in the array are placed behind the bottom, front, house left module, or along the (x) axis.

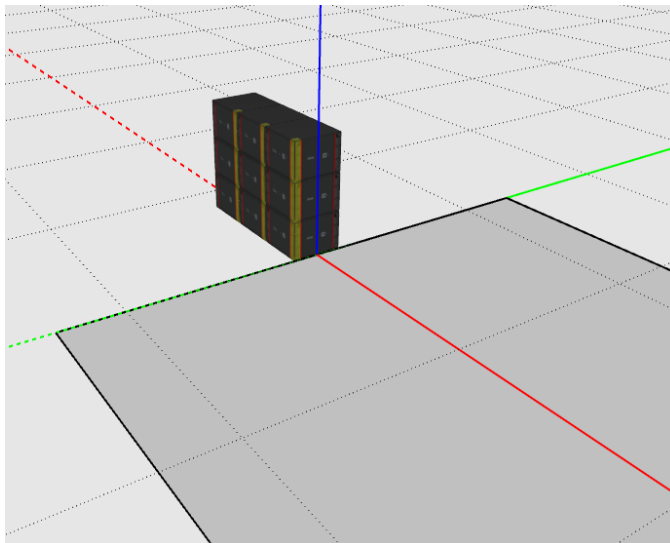

Using Mixed Adaptive Arrays

When hanging combinations of Adaptive products (for example Anya and Anna together), the array assistant can be utilized to quickly optimize and configure the mixed array. To utilize this functionality, simply enter in the number of both Anya and Anna modules available, select the appropriate hang style, then select 'next'.

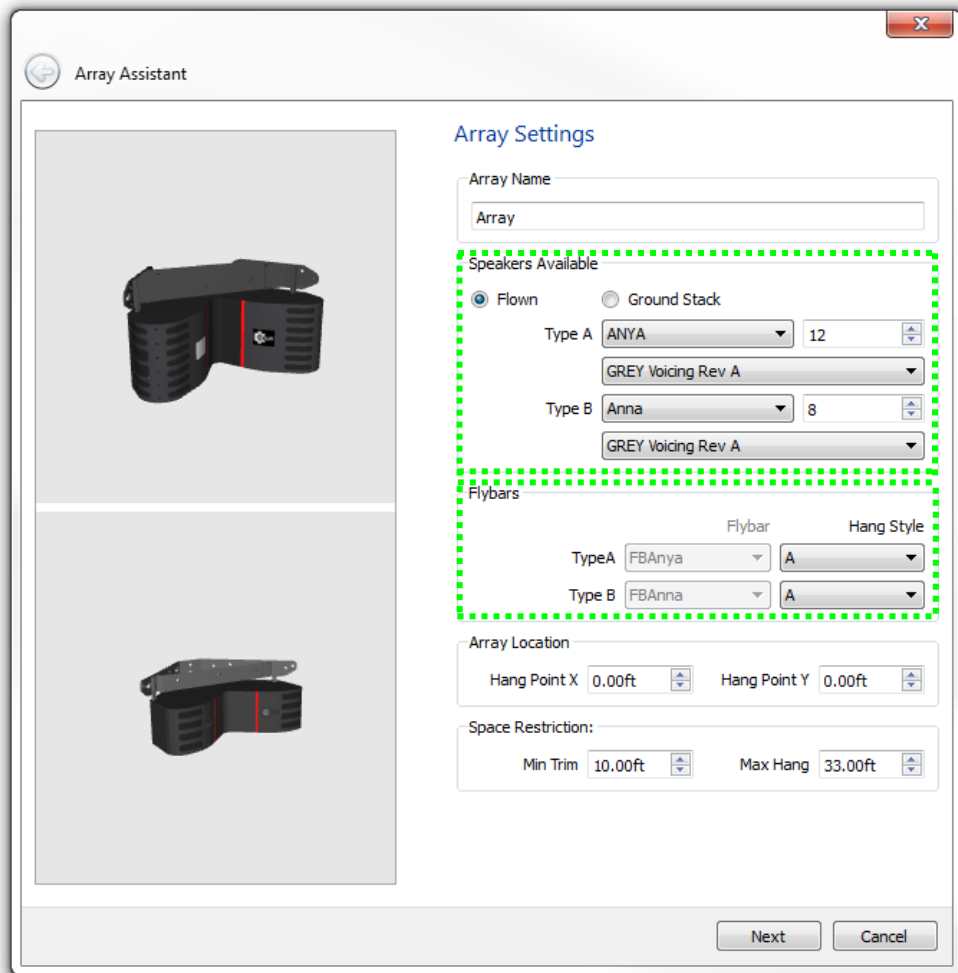

Adjust the coverage and sliders as you would normally. The array assistant will then return the ideal mixed array configuration for a given input venue geometry.

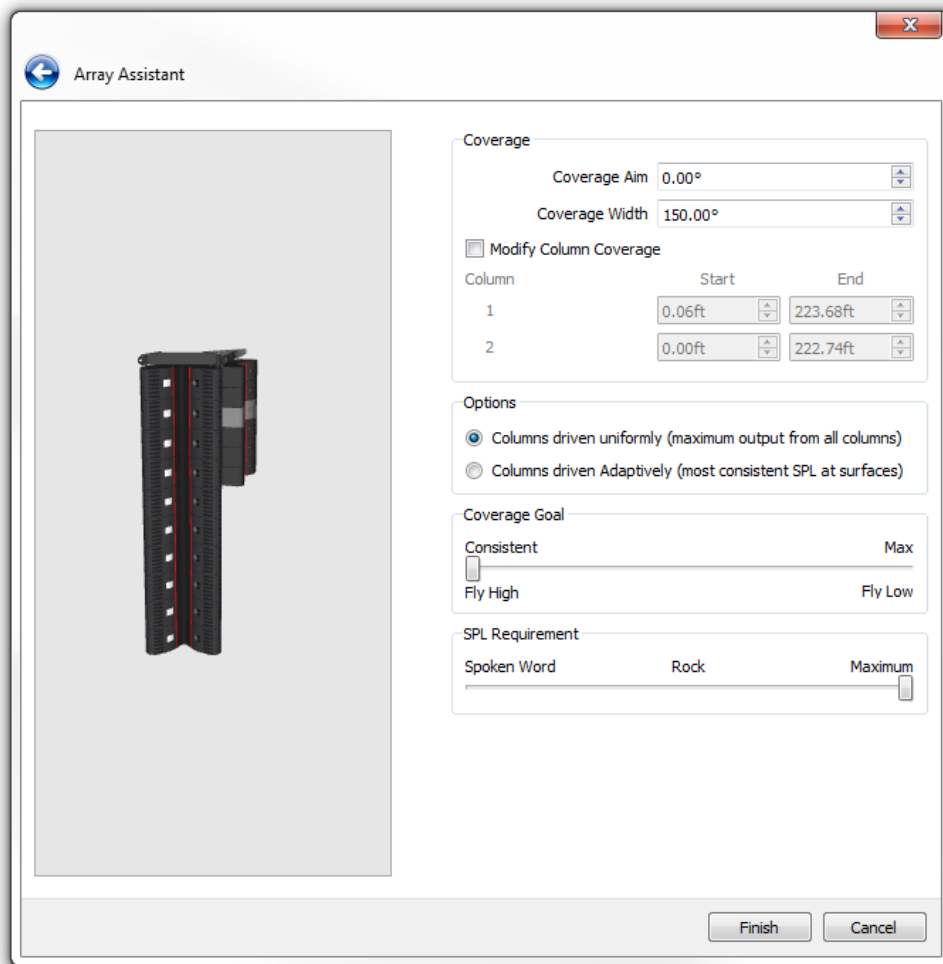

It's important to note that the array assistant may not use all the modules available, it will choose the optimal number of modules based on user input venue geometry and selections made on the 'coverage goal' sliders. Should you wish to manually adjust modules in the adaptive arrays, you can do so in the 'Array View' or 'Project Explorer' windows.

Find Me (Trilateration)

Trilateration provides users with the ability to “map” a venue in 3D utilizing only two Anya arrays, a computer running both Resolution and Smaart, and a measurement microphone. To utilize this feature, the following is needed:

- Two Anya arrays (i.e. stage-left and stage-right). At least one array must have two or more modules. The relative locations of the arrays (height and width) relative to one another must be known.
- A computer running both Resolution 2 and Smaart 7.2 or later (within one operating system; this cannot be split across multiple OSs via virtualization).
- An audio interface and measurement microphone. At least one transfer function must be configured in Smaart (a two-channel measurement).
- A stimulus (noise) source, either in Smaart or external, fed to both the Anya system and the reference channel in Smaart.
- A reasonable working knowledge of Smaart 7 and measurement best practices.

Initial Setup

To configure Smaart to work with Resolution, several configuration steps are necessary:

- Under the “Options” menu, ensure that under “API”, “Enabled” is checked, and that the Port is set to 26000.
- Under the “Delay” tab (also under the “Options” dialog), select an FFT size that results in a time constant that is significantly longer than the longest time-of-flight from the array to the microphone. For more help in selecting an appropriate FFT size, consult the Smaart 7 Help File.
- For most applications, a 32k FFT with 3 averages will be sufficient with 44.1 kHz or 48 kHz sampling rates. This corresponds to a flight-time of approximately 700-800 feet.
- Go online and assign all Anya arrays.

Step 1

Open the **Find Me** dialog, which can be found in the Tools menu. The following dialog box will be displayed:

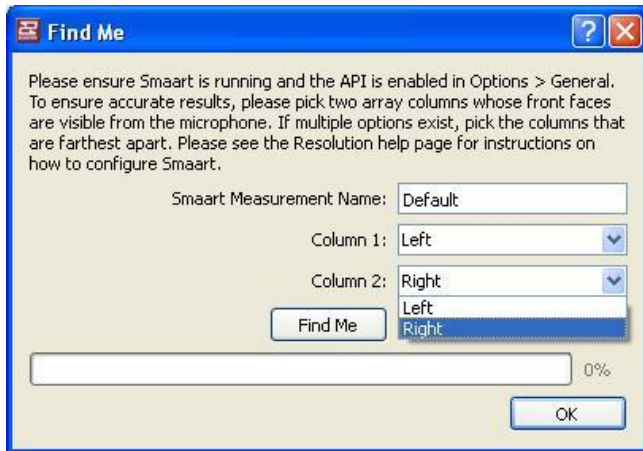

Enter the exact name corresponding to the transfer function (TF) configured in Smaart:

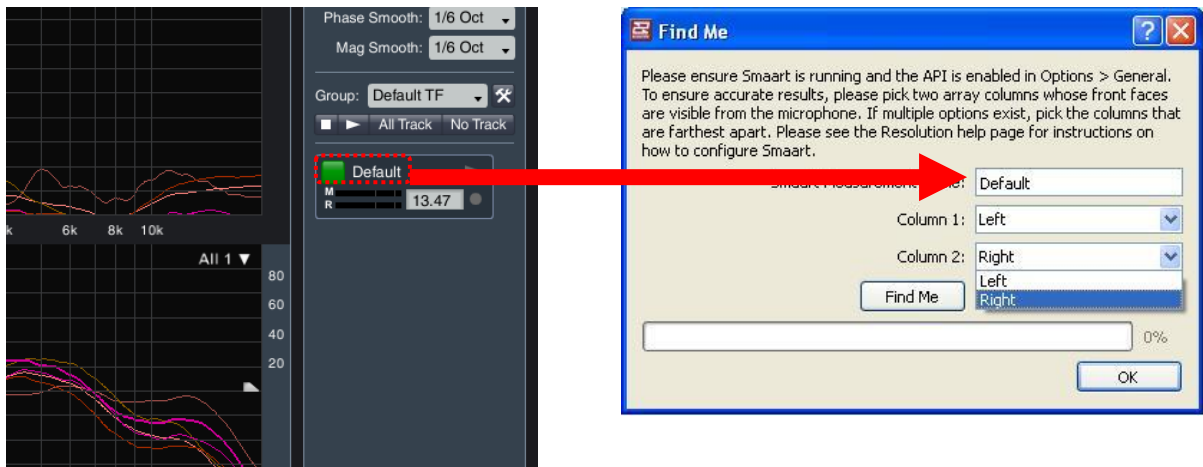

For “Column 1” and “Column 2”, define the two columns to be used for the measurement. These should *not* be columns within the same array. For the best accuracy, using widely-spaced columns is suggested (i.e. Column 1 is stage-left and Column 2 is stage-right). It is also recommended that the user select columns that are horizontally aimed at the microphone position.

After this is complete, click “OK”.

Step 2

The following dialog will be displayed:

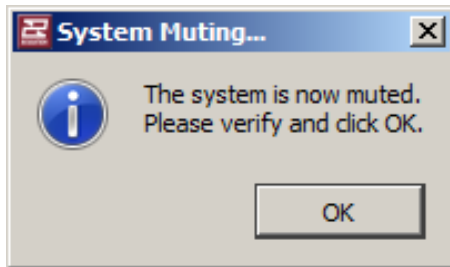

This indicates that the entire Anya system has muted. The user should verify this by applying the stimulus source (noise) to the system. No noise should be audible from the system. This confirms communication with all modules. Click "OK".

Step 3

The following dialog will be displayed:

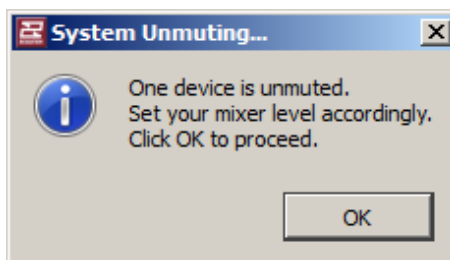

This indicates that a single cell from one column has been unmuted. The user should then increase the noise output level (via the audio interface, mixer, or both) until a suitable balance between measurement and reference channels is achieved. The criteria for trilateration to function correctly are the same as for achieving a good transfer function measurement. For more help on this, please consult the Smart 7 Help File.

Once "OK" is selected, Resolution will begin the **Find Me** routine. The stimulus signal will continue to be audible, and will move between several devices in both arrays. Do not modify any system parameters while this process is underway.

If successful, a virtual microphone will be placed within the model at the coordinate of the actual microphone. This microphone will be labeled "Find Me Result".

The following dialog will then be displayed:

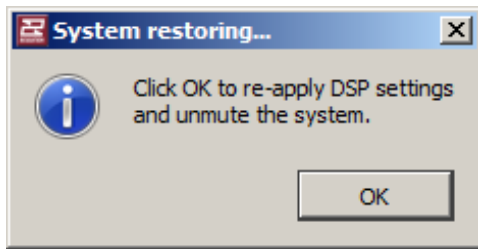

The user should now turn off the noise source and restore the original mixer levels. Once “OK” is clicked, the entire Anya system will unmute and return to its state prior to using the **Find Me** function.

To define an entire venue, the user may wish to repeat this process several times, moving the microphone to a new location within the audience area and repeating these steps. Audience areas may then be drawn connecting these virtual microphones to form coverage areas.

If **Find Me** is unsuccessful, the following dialog will appear:

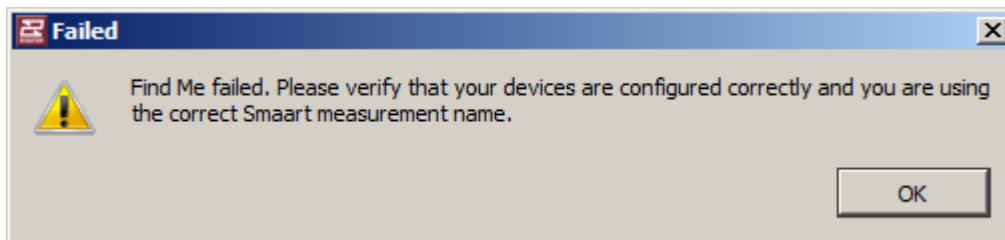

This could occur for several reasons, including:

- The incorrect name is entered under “Smaart Measurement Name” in the initial Find Me dialog.
- The API is not enabled in Smaart, or the correct port number is not set.
- The signal-to-noise ratio is insufficient to capture accurate delay times, or the measurement system is not properly configured.
- The arrays are not near their indicated positions.

To resolve these issues, the user should first ensure that they are able to obtain a valid transfer function measurement in Smaart. **Find Me** works by using the API to run the Smaart Delay Finder multiple times and capture the results. If the Smaart Delay Finder is not able to produce accurate results, Find Me will fail.

Section 7 - Appendix

Anya/Anna Voicings

Just as multiple “voicings” or tonalities (in the form of color-coded Greyboxes) are offered with EAW Microwedge loudspeakers, Anya offers users the choice of a variety of different tunings to suit different musical styles and engineer tastes. Below, the target response and a brief explanation are provided for each voicing.

Please note that to change from voicing to another, the acoustical model must be re-calculated (this is necessary to optimize internal gain-staging). All voicings are optimized to achieve the best possible gain-staging and coverage with Anya systems.

White

This represents a nominally flat voicing (prior to addition of air loss compensation, which is automatic for Anya/Anna). The White voicing should be used when the most neutral, uncolored system response is desired.

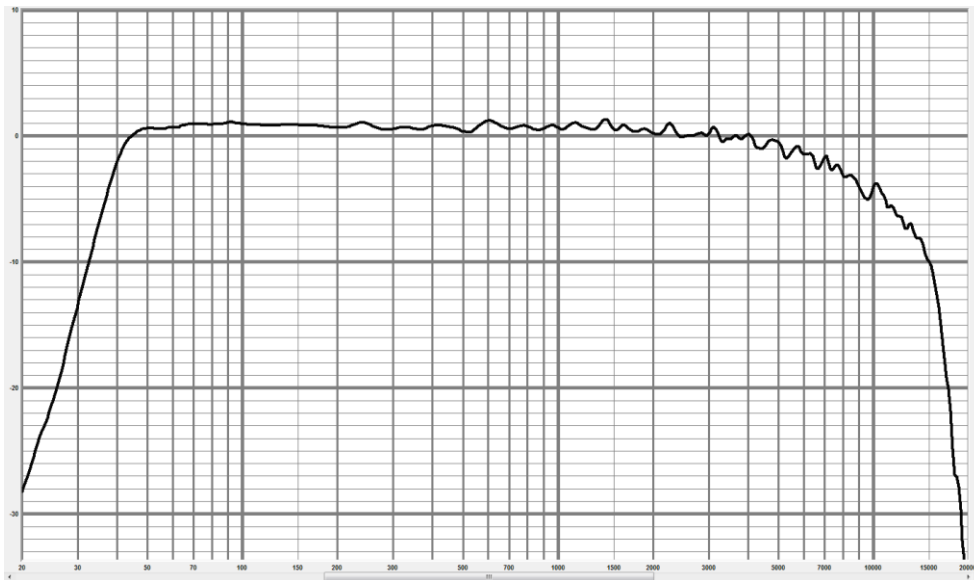

Grey

Compared to White, the Grey voicing provides a 1 dB low-frequency boost with a gradual high-frequency roll-off, reaching 4 dB at 10 kHz.

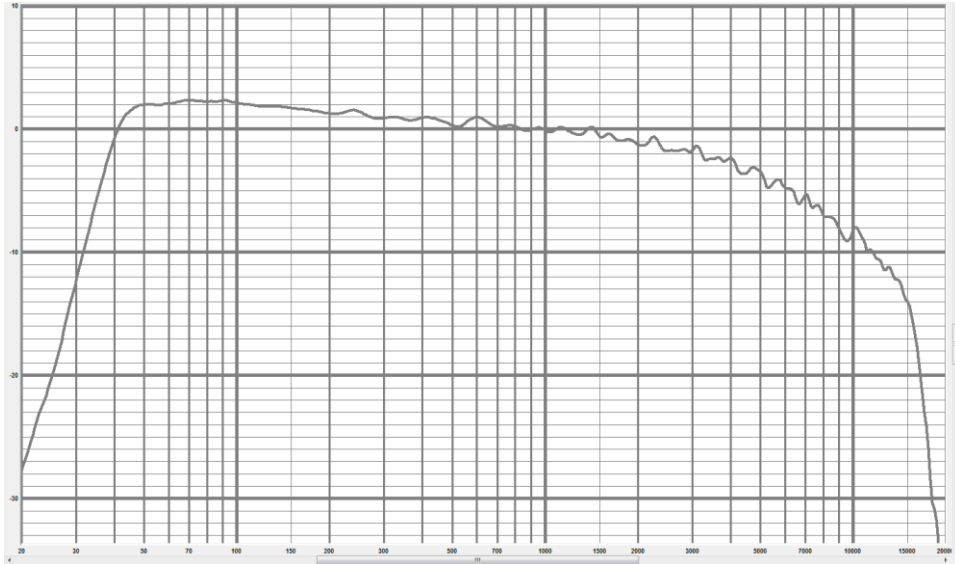

Blue

The Blue voicing provides a more significant 2 dB low-frequency boost, coupled with the same high-frequency roll-off as Grey, but with 2 dB more mid-frequency attenuation from 700 Hz to 8,000 Hz.

This voicing is most suitable for high-SPL performances with significant upper-mid content. The more extensive mid- and high-frequency attenuation is sometimes useful to combat fatigue with midrange-heavy instruments, as the ear is most sensitive to this range of frequencies.

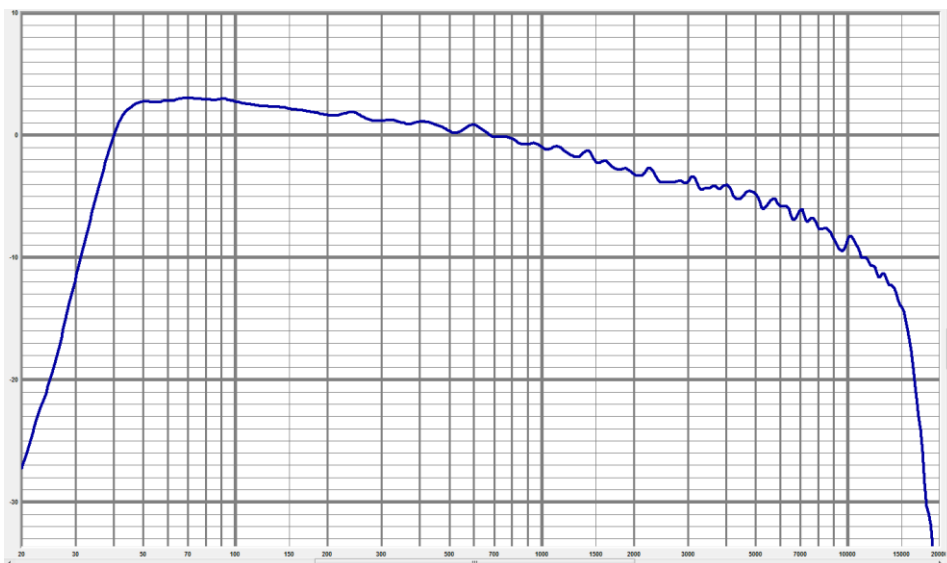

Sapphire

The Sapphire voicing combines the low-frequency boost and high-frequency attenuation of Blue, but with the addition of additional very high-frequency emphasis above 10 kHz for additional “air” and clarity. This voicing is especially suitable for high-quality audio playback (without the need for supplemental equalization), and was the result of feedback from a number of touring audio engineers.

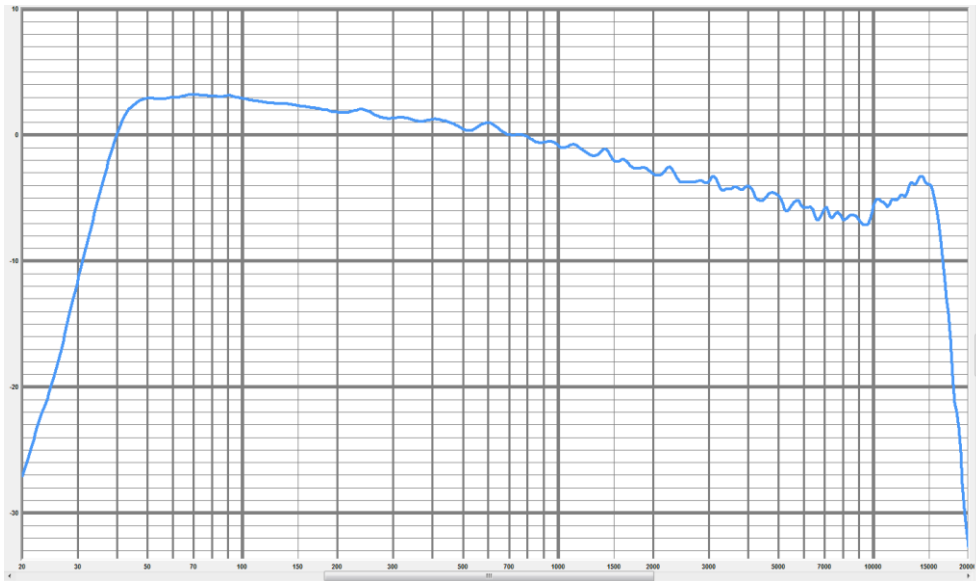

Summary

The following figure illustrates all four previously-discussed voicings. The black response is the “white” voicing. Blue, grey and sapphire are as they appear.

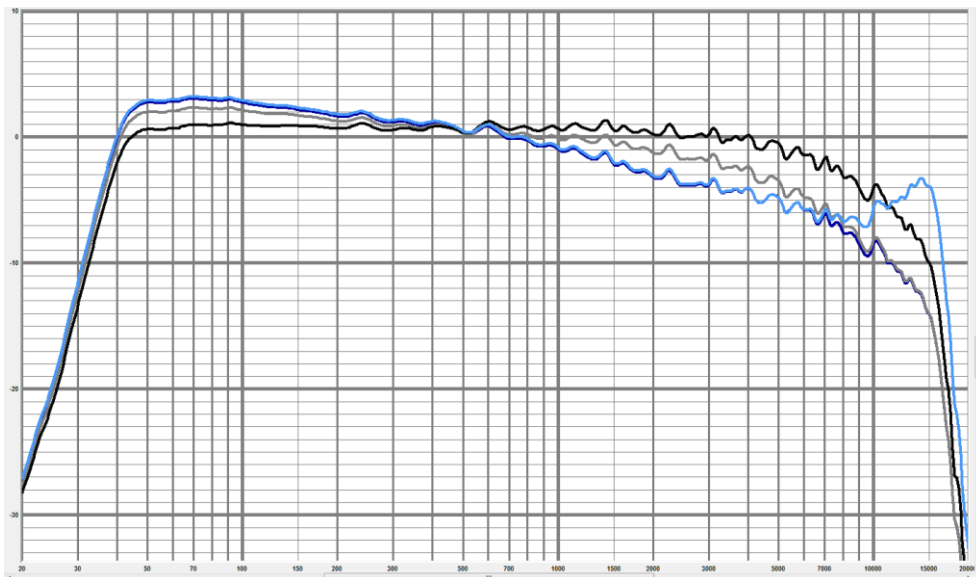

Exporting from Resolution into EASE

In Resolution, select the tab of the array you wish to export in the 'Project Explorer' window. Select 'Export EASE file' from the 'File' menu. Note that if more than one array exists in the Resolution model, you must select the specific array you would like to export. If the 'Venue' tab is selected in the 'Project Explorer' window, the 'Export EASE file' option will be unavailable (greyed out).

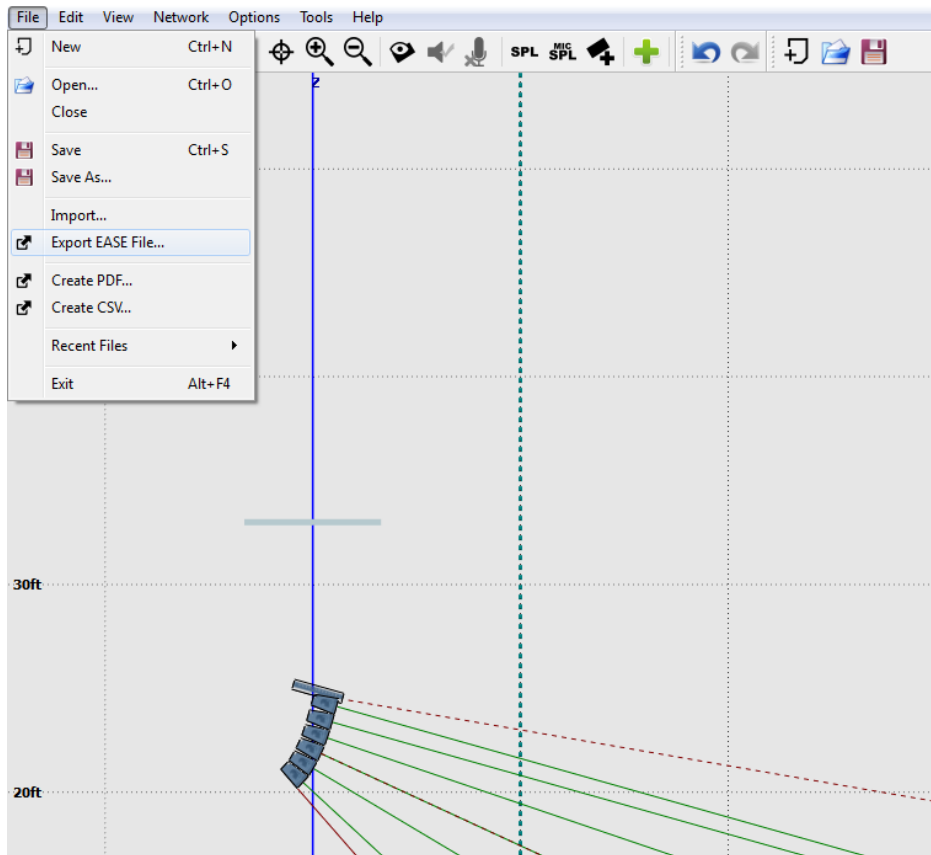

After the user designates a location to save the file, Resolution will calculate a complete three-dimensional balloon for the selected array, which will be centered on the array's pick point. The calculated balloon will include any vertical tilt in the array, but will set the horizontal aim angle to zero. In other words, you will not need to re-tilt the array vertically, but it will be necessary to re-apply any horizontal rotation once you have imported the data to EASE.

Next, the user must import the .XHN file created by Resolution into EASE Speaker Base. Open Speaker Base, and select 'Import ASCII' from the 'File' menu.

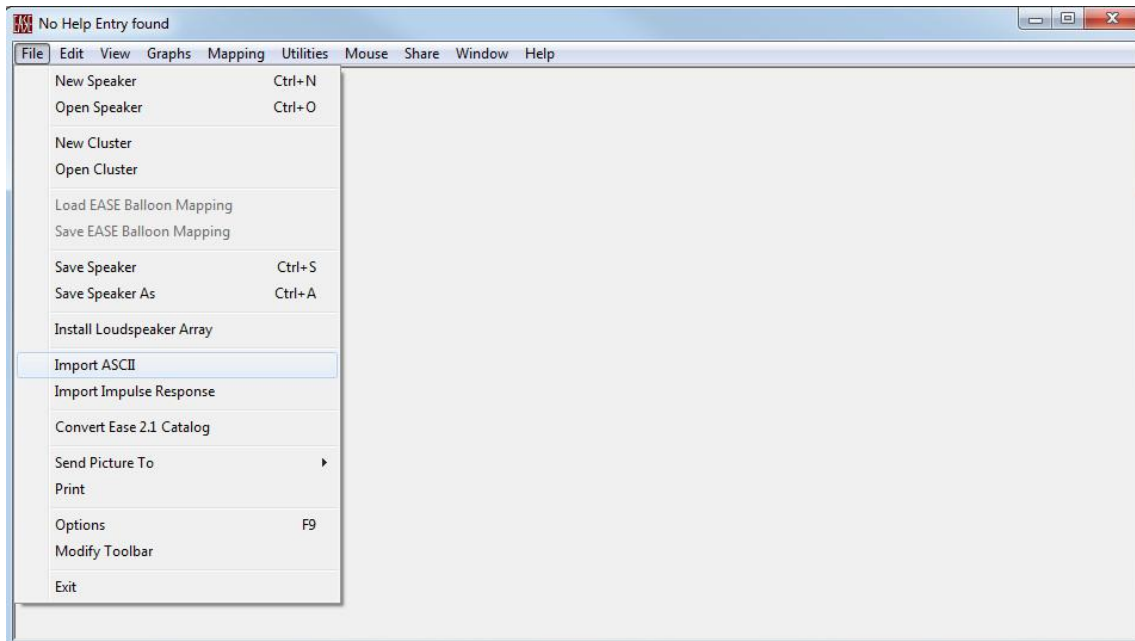

Next, select a location to save the new loudspeaker files. Speaker Base will select a default project folder, so it is suggested that the user select a more familiar location for the new loudspeaker data. To do this, click on 'Change Destination Path For All Files' and indicate the desired location. EASE will place a number of files in this directory.

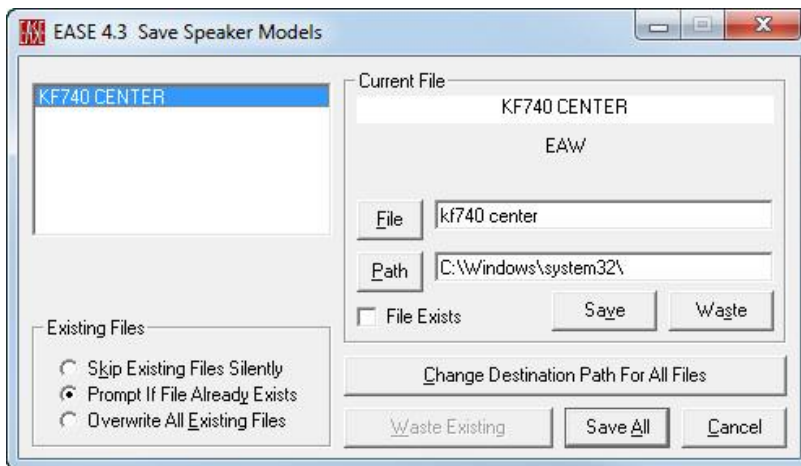

After a suitable path has been selected, select 'Save All'.

Next, select 'Speaker Model' from the 'Edit' menu.

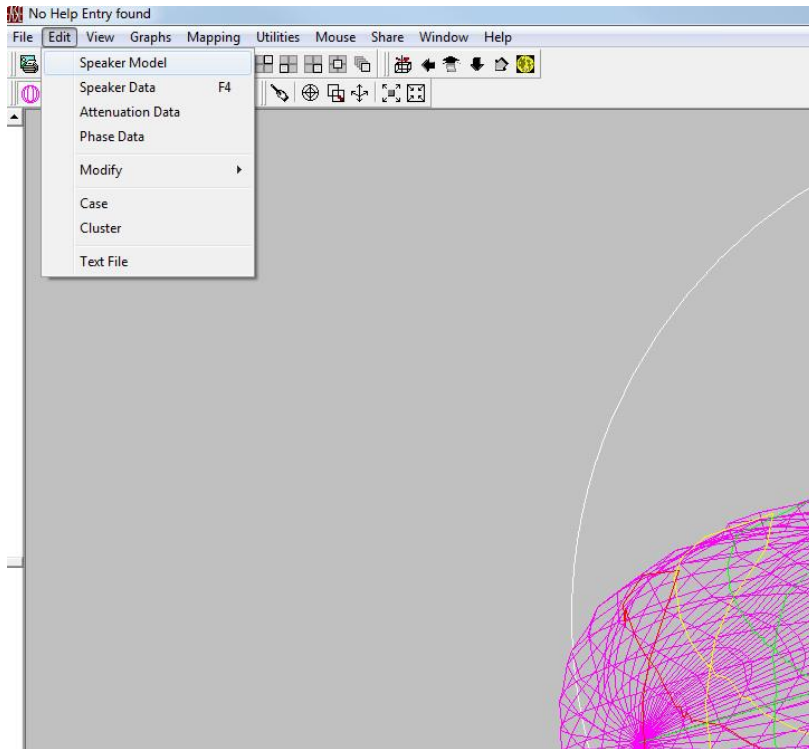

In the dialogue box, select 'Check Speaker' so that the 'Checked' field indicates 'Yes'. You may also enter a name for the loudspeaker model. Click 'OK'.

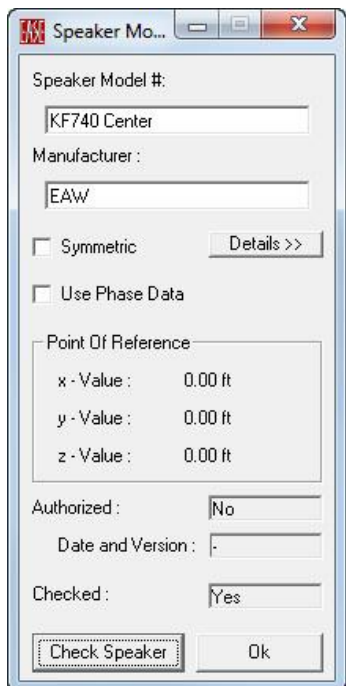

Next, EASE requires you to run calculations on the data. These are accessed via the 'Speaker Data' function in the 'Edit' menu. This dialogue box can also be accessed quickly by pressing the 'F4' keyboard key.

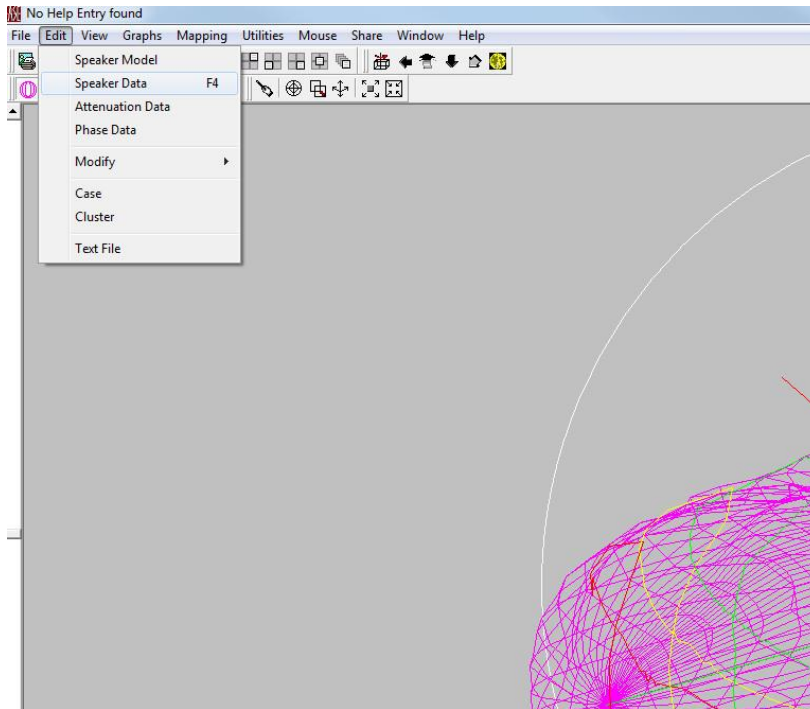

In the 'Speaker Data' dialogue box, perform the following functions in order:

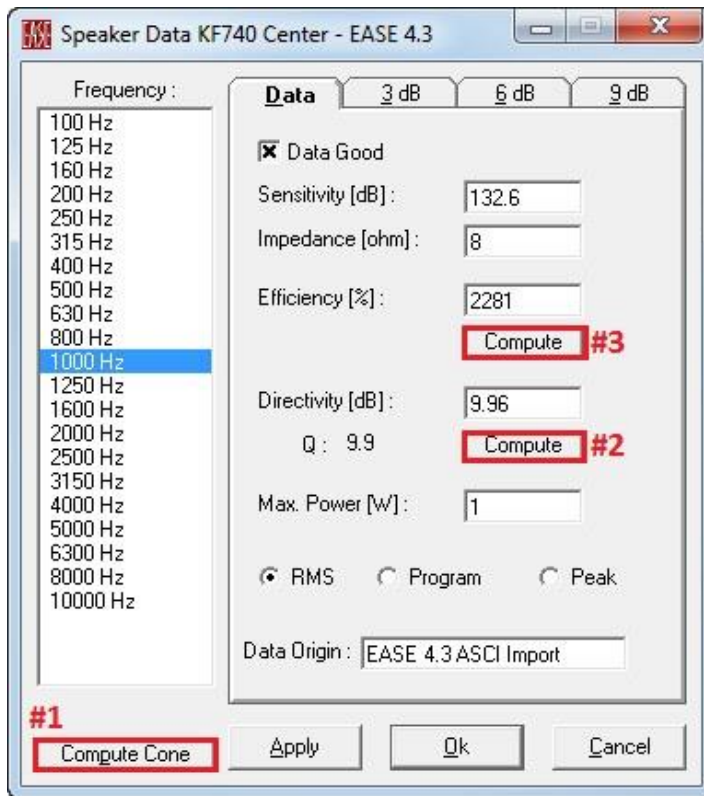

1. **Compute Cone**
2. **Compute Directivity:** You may be asked if you wish to do this for all bands. Click 'Ok'.
3. **Compute Efficiency:** You may again be asked if you wish to do this for all bands. Click 'Ok'.
4. **Apply, and click 'Ok'.**

These functions ensure that the correct directivity and output data is included in the loudspeaker model.

The final step is to save the correctly formatted and calculated loudspeaker. Simply select 'Save' from the 'File' menu.

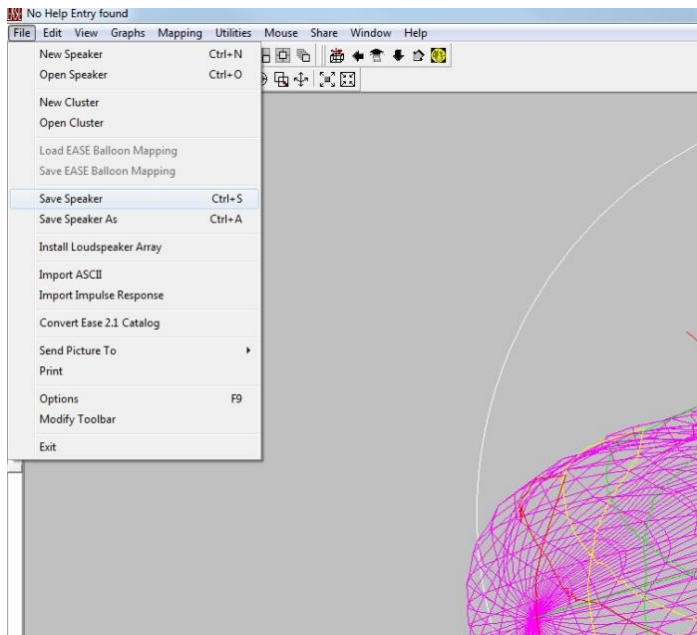

Speaker Base will save the data as a .SPK file, and will also include several other files sharing the name but using different extensions (.spk, .fed, .ffc, .frd, .fvt, .fwm, and .lob). It is critical that all of these files are kept together.

You can now utilize the exported model in any EASE simulation, just as you would any other loudspeaker. Remember that the loudspeaker (representing your array) should be positioned in the model at the pick point, as indicated in Resolution. While any tilt will be included in the data exported from Resolution (the EASE object should be left at 0 degrees vertical), it will be necessary to horizontally aim the array within EASE as appropriate.

Upgrading Firmware on Adaptive Modules

Select **Tools>Firmware Manager**:

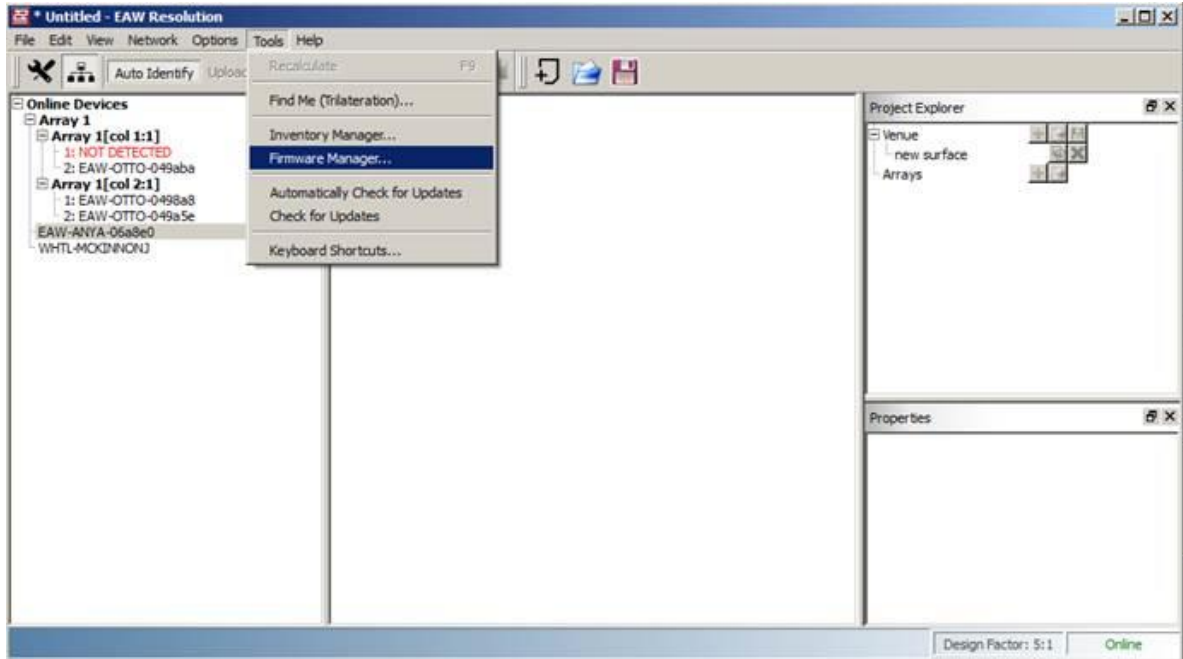

Or, open any diagnostic window and select **Update Firmware**:

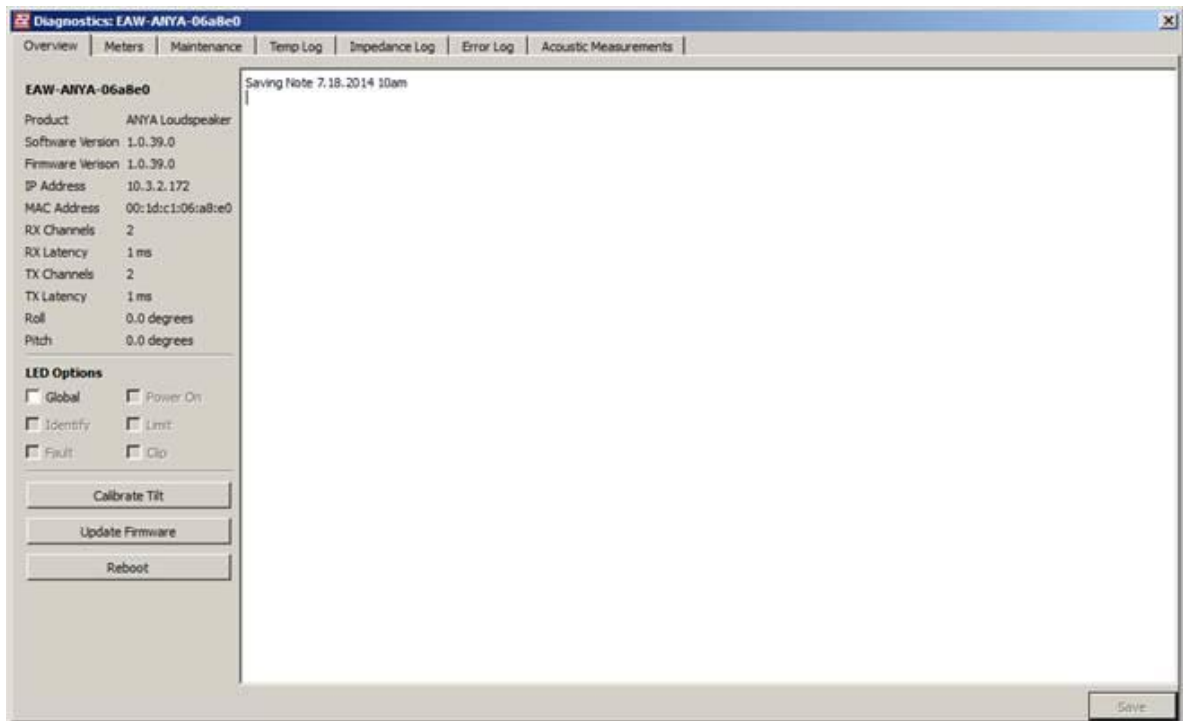

Select the firmware file (.eawfw) in C:\ProgramData\EAW Resolution:

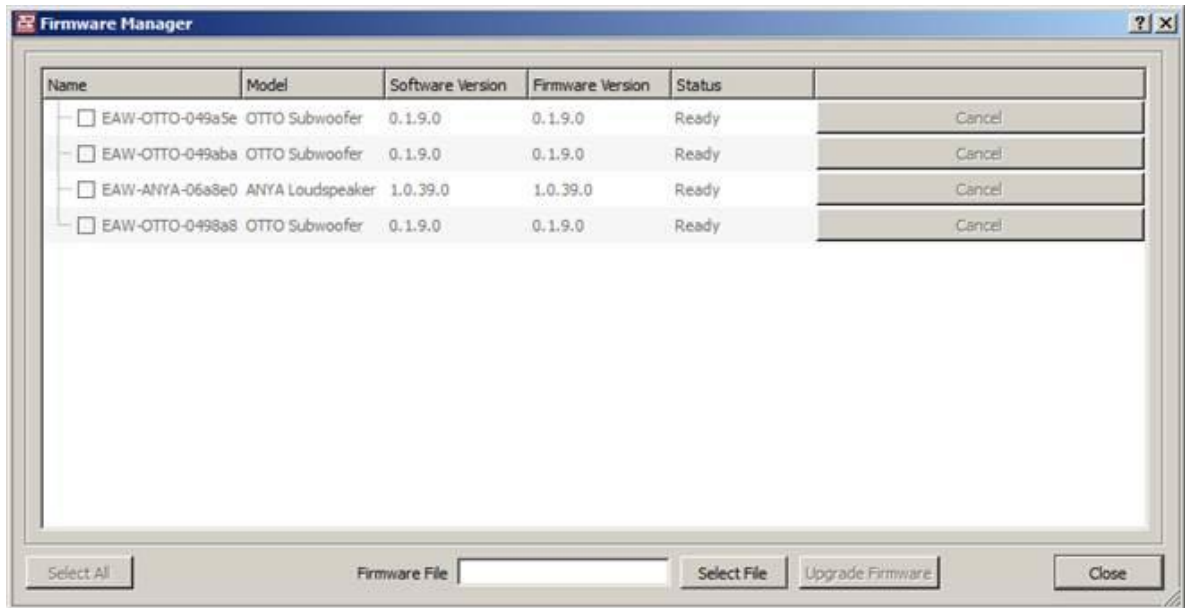

Select the Anya modules you wish to upgrade (or select all):

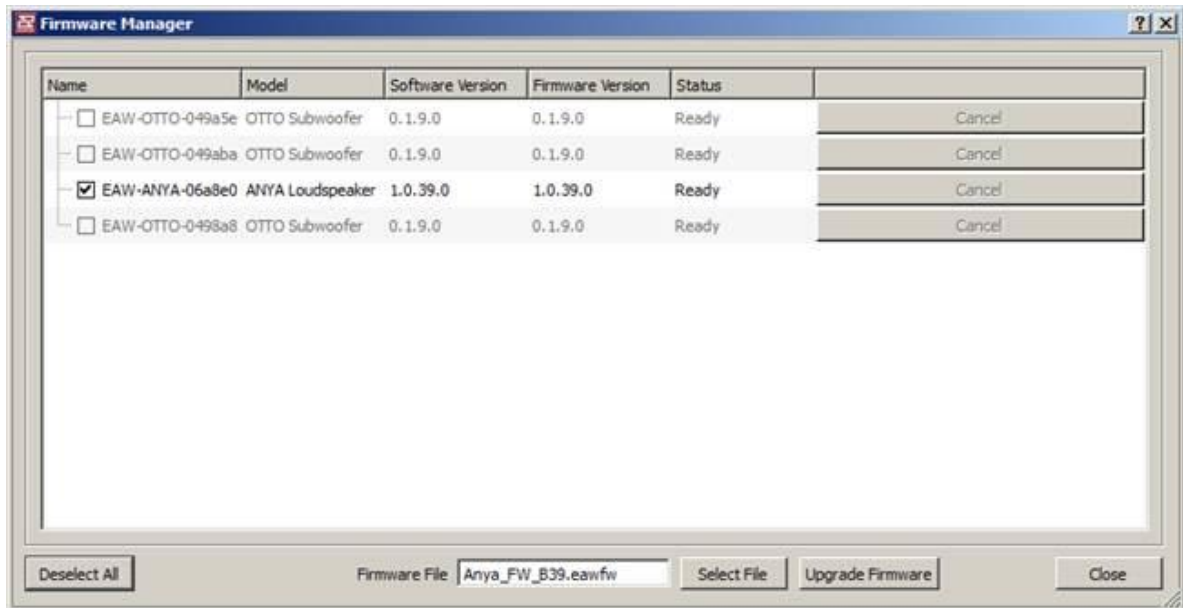

Select **Upgrade Firmware**:

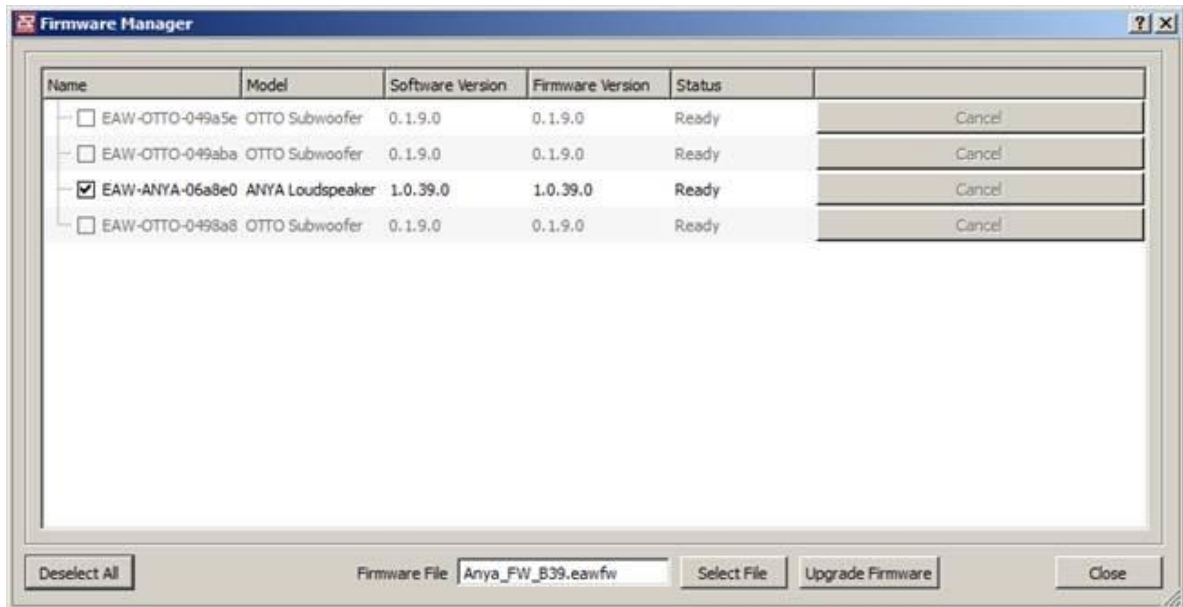

The upgrade is complete when the status indicates 'Finished'. The status will return to 'Ready' about 30 seconds after it has finished.

Upgrading Firmware on NTX & Radius Modules

NOTE: Before starting Firmware update, please turn the Windows Firewall off.

NOTE: It is highly recommended you run the firmware update with a DHCP server connected to the network. If not, each Radius module will need to be placed in Firmware update mode (power each unit on while holding down the scroll wheel). After about a minute in being placed in this mode, each module will have an IP address assigned. This will need to be noted then manually entered under the IP Address column as it corresponds to the physical hardware unit. This will need to be done before clicking Upgrade Firmware.

Select **Tools>Firmware Manager:**

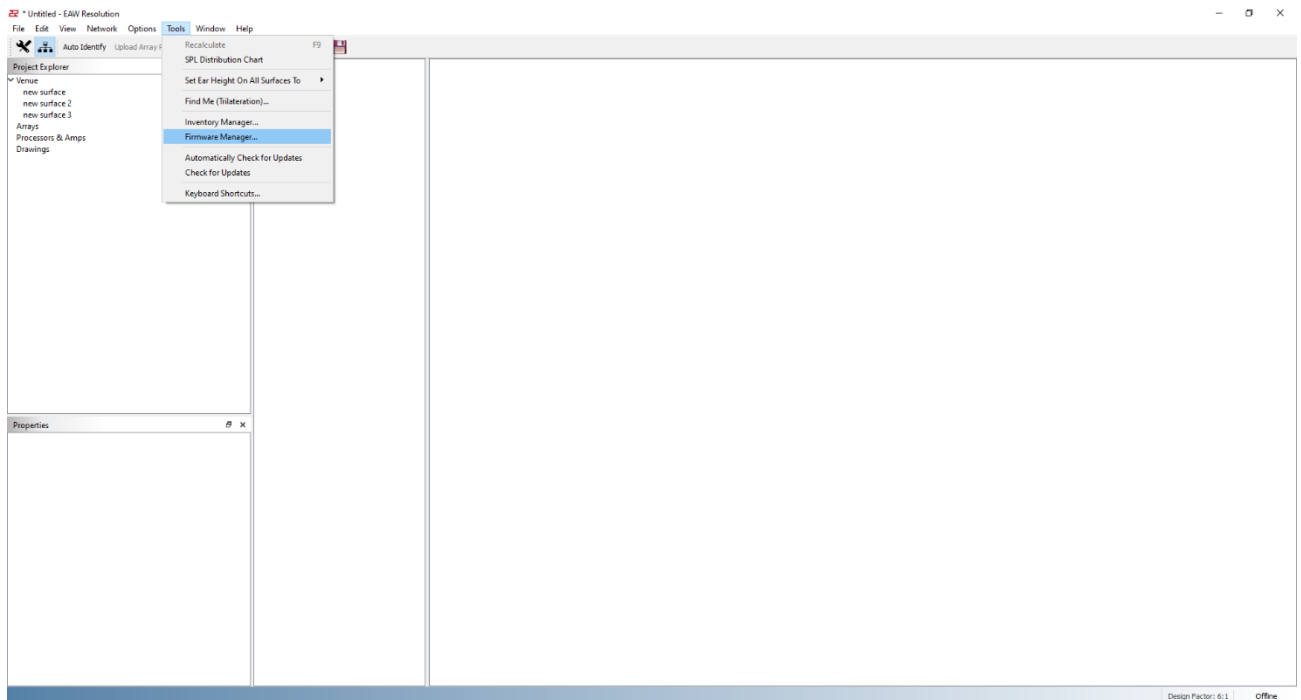

Select the firmware file (.eawfw) in C:\ProgramData\EAW Resolution:

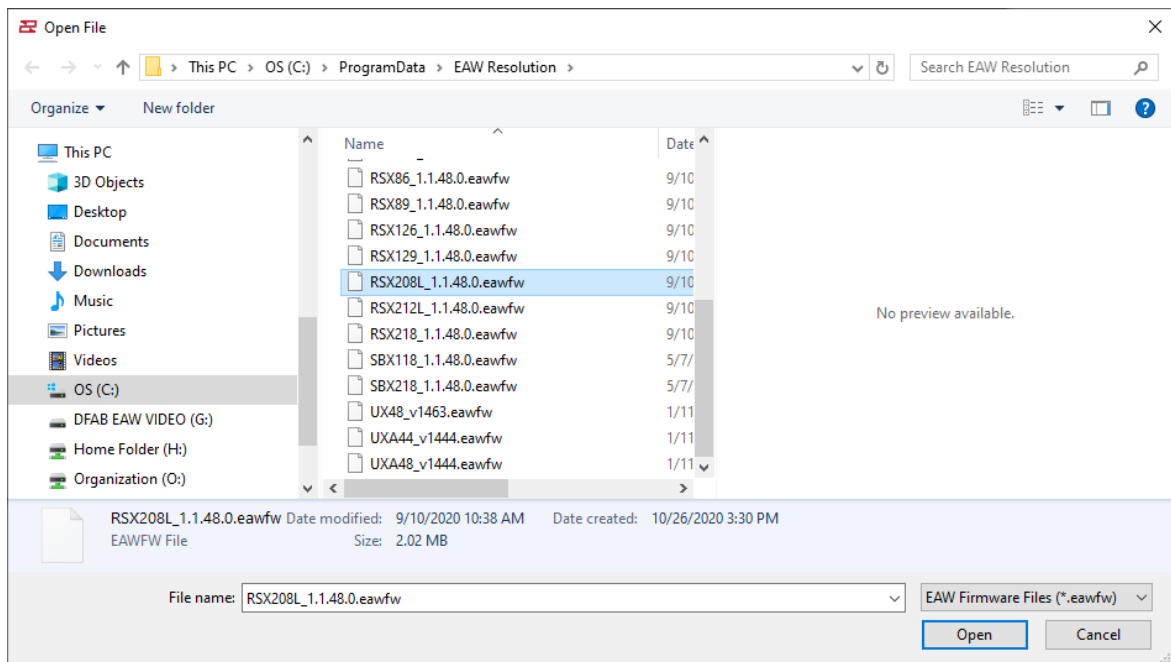
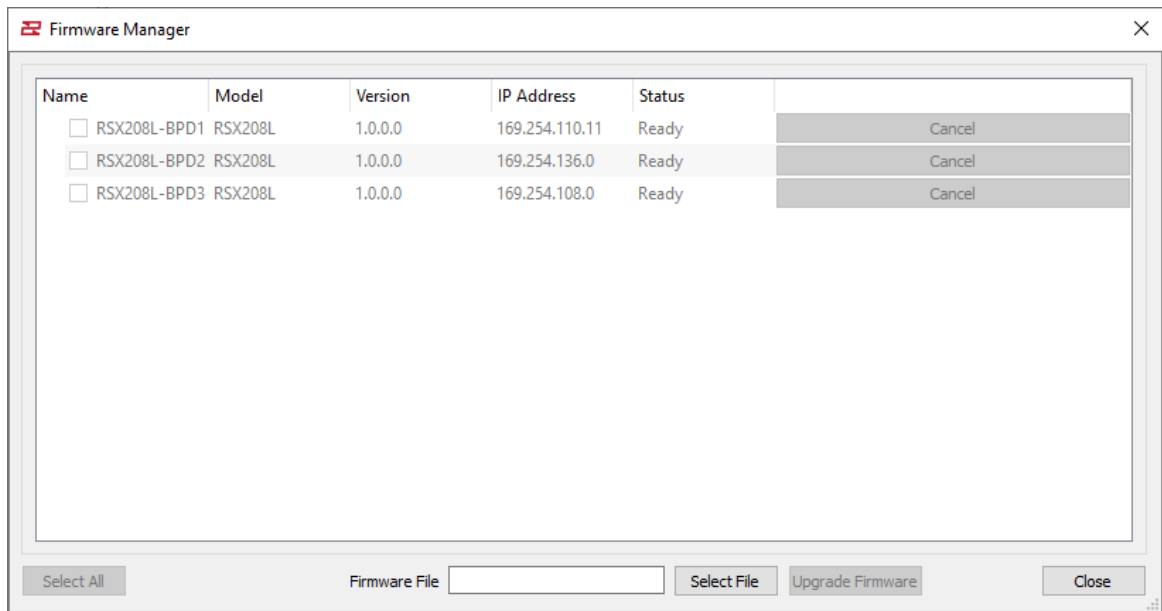

Select the Radius modules you wish to upgrade (or select all):

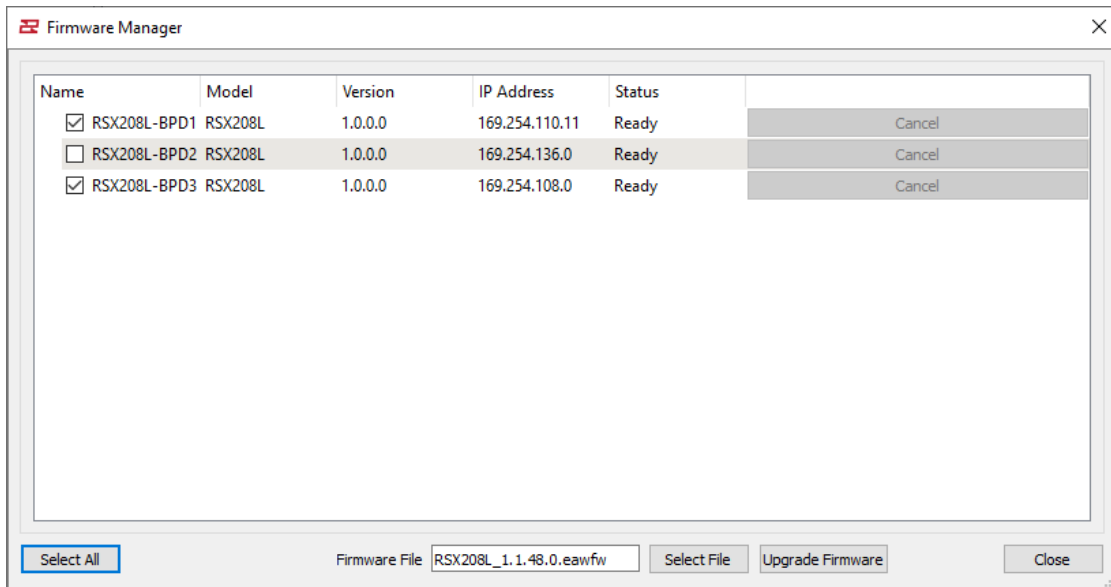

Select **Upgrade Firmware**.

The upgrade is complete when the status indicates 'Finished'. The status will return to 'Ready' about 30 seconds after it has finished.

Upgrading Firmware on UX/UXA Devices

Generally, the upgrade process should be the same for these devices as it is for Adaptive and Radius. However, significant changes have been made to the firmware such that devices on older firmware versions will require a two-step upgrade process that will confirm hardware compatibility with the latest firmware version. UX firmware version 1456 and UXA firmware 1444 require this two-step process which is fully automated by the Firmware Manager.

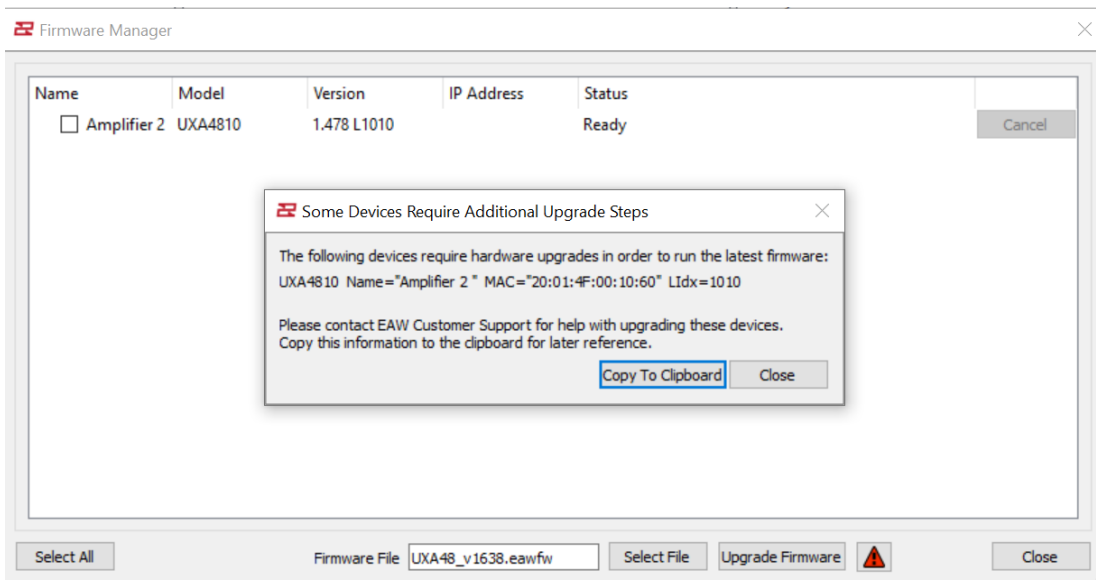

If the firmware upgrade fails due to incompatible hardware, the Firmware Manager will inform the user that they need to contact EAW customer support for further assistance on upgrading the device. The information in the dialog should be recorded and forwarded to EAW customer support. The MAC address, shown in the dialog, provides a unique network identifier for the device while the LIdx value provides internal hardware version information. The device is not stable when on the intermediate formware version (v1478, in this case), so the Firmware Manager will downgrade the device in the background. While the Firmware Manager is open, a warning button is displayed beside the Upgrade Firmware button. This button will recall the device information dialog.

Contacting EAW

We have attempted to make this Help File as thorough as possible. However, feel free to contact us with any further questions or comments for topics not covered.

Operating Questions

EAW Application Engineering
Tel 508-234-6158 x 2
Tel 800-992-5013 x 2 (USA only)
E-mail design@eaw.com

General

Eastern Acoustic Works
One Main Street
Whitinsville, MA 01588 USA
Tel 508-234-6158
Tel 800-992-5013 (USA only)
Web <http://www.eaw.com>

Updated 9/30/2019

This EAW product includes software code developed by third parties, including QT, subject to the GNU LESSER GENERAL PUBLIC LICENSE (“LGPL”) Version 3. Where such specific license terms entitle you to the source code of such software, LOUD Technologies Inc. will provide upon written request via email or traditional paper mail the applicable LGPL source code files via CD-ROM for a nominal cost to cover media, shipping and handling charges as allowed under the LGPL.

The LGPL code used in this product is distributed WITHOUT ANY WARRANTY and is subject to the copyrights of one or more authors. See below for the LGPL and GPL license.

Please direct all GPL Source Requests to the following email/address.

Attn: LGPL Resolution Source Request

Eastern Acoustic Works

One Main Street Building 13

Whitinsville, MA 01588

or

design@eaw.com

GNU GENERAL PUBLIC LICENSE

Version 3, 29 June 2007

Copyright (C) 2007 Free Software Foundation, Inc. <<http://fsf.org/>>

Everyone is permitted to copy and distribute verbatim copies of this license document, but changing it is not allowed.

Preamble

The GNU General Public License is a free, copyleft license for software and other kinds of works.

The licenses for most software and other practical works are designed to take away your freedom to share and change the works. By contrast, the GNU General Public License is intended to guarantee your freedom to share and change all versions of a program--to make sure it remains free software for all its users. We, the Free Software Foundation, use the GNU General Public License for most of our software; it applies also to any other work released this way by its authors. You can apply it to your programs, too.

When we speak of free software, we are referring to freedom, not price. Our General Public Licenses are designed to make sure that you have the freedom to distribute copies of free software (and charge for them if you wish), that you receive source code or can get it if you

want it, that you can change the software or use pieces of it in new free programs, and that you know you can do these things.

To protect your rights, we need to prevent others from denying you these rights or asking you to surrender the rights. Therefore, you have certain responsibilities if you distribute copies of the software, or if you modify it: responsibilities to respect the freedom of others.

For example, if you distribute copies of such a program, whether gratis or for a fee, you must pass on to the recipients the same freedoms that you received. You must make sure that they, too, receive or can get the source code. And you must show them these terms so they know their rights.

Developers that use the GNU GPL protect your rights with two steps: (1) assert copyright on the software, and (2) offer you this License giving you legal permission to copy, distribute and/or modify it.

For the developers' and authors' protection, the GPL clearly explains that there is no warranty for this free software. For both users' and authors' sake, the GPL requires that modified versions be marked as changed, so that their problems will not be attributed erroneously to authors of previous versions.

Some devices are designed to deny users access to install or run

modified versions of the software inside them, although the manufacturer can do so. This is fundamentally incompatible with the aim of protecting users' freedom to change the software. The systematic pattern of such abuse occurs in the area of products for individuals to use, which is precisely where it is most unacceptable. Therefore, we have designed this version of the GPL to prohibit the practice for those products. If such problems arise substantially in other domains, we stand ready to extend this provision to those domains in future versions of the GPL, as needed to protect the freedom of users.

Finally, every program is threatened constantly by software patents. States should not allow patents to restrict development and use of software on general-purpose computers, but in those that do, we wish to avoid the special danger that patents applied to a free program could make it effectively proprietary. To prevent this, the GPL assures that patents cannot be used to render the program non-free.

The precise terms and conditions for copying, distribution and modification follow.

TERMS AND CONDITIONS

0. Definitions.

"This License" refers to version 3 of the GNU General Public License.

"Copyright" also means copyright-like laws that apply to other kinds of works, such as semiconductor masks.

"The Program" refers to any copyrightable work licensed under this License. Each licensee is addressed as "you". "Licensees" and "recipients" may be individuals or organizations.

To "modify" a work means to copy from or adapt all or part of the work in a fashion requiring copyright permission, other than the making of an exact copy. The resulting work is called a "modified version" of the earlier work or a work "based on" the earlier work.

A "covered work" means either the unmodified Program or a work based on the Program.

To "propagate" a work means to do anything with it that, without permission, would make you directly or secondarily liable for infringement under applicable copyright law, except executing it on a computer or modifying a private copy. Propagation includes copying, distribution (with or without modification), making available to the public, and in some countries other activities as well.

To "convey" a work means any kind of propagation that enables other parties to make or receive copies. Mere interaction with a user through

a computer network, with no transfer of a copy, is not conveying.

An interactive user interface displays "Appropriate Legal Notices" to the extent that it includes a convenient and prominently visible feature that (1) displays an appropriate copyright notice, and (2) tells the user that there is no warranty for the work (except to the extent that warranties are provided), that licensees may convey the work under this License, and how to view a copy of this License. If the interface presents a list of user commands or options, such as a menu, a prominent item in the list meets this criterion.

1. Source Code.

The "source code" for a work means the preferred form of the work for making modifications to it. "Object code" means any non-source form of a work.

A "Standard Interface" means an interface that either is an official standard defined by a recognized standards body, or, in the case of interfaces specified for a particular programming language, one that is widely used among developers working in that language.

The "System Libraries" of an executable work include anything, other than the work as a whole, that (a) is included in the normal form of packaging a Major Component, but which is not part of that Major

Component, and (b) serves only to enable use of the work with that Major Component, or to implement a Standard Interface for which an implementation is available to the public in source code form. A "Major Component", in this context, means a major essential component (kernel, window system, and so on) of the specific operating system (if any) on which the executable work runs, or a compiler used to produce the work, or an object code interpreter used to run it.

The "Corresponding Source" for a work in object code form means all the source code needed to generate, install, and (for an executable work) run the object code and to modify the work, including scripts to control those activities. However, it does not include the work's System Libraries, or general-purpose tools or generally available free programs which are used unmodified in performing those activities but which are not part of the work. For example, Corresponding Source includes interface definition files associated with source files for the work, and the source code for shared libraries and dynamically linked subprograms that the work is specifically designed to require, such as by intimate data communication or control flow between those subprograms and other parts of the work.

The Corresponding Source need not include anything that users can regenerate automatically from other parts of the Corresponding Source.

The Corresponding Source for a work in source code form is that same work.

2. Basic Permissions.

All rights granted under this License are granted for the term of copyright on the Program, and are irrevocable provided the stated conditions are met. This License explicitly affirms your unlimited permission to run the unmodified Program. The output from running a covered work is covered by this License only if the output, given its content, constitutes a covered work. This License acknowledges your rights of fair use or other equivalent, as provided by copyright law.

You may make, run and propagate covered works that you do not convey, without conditions so long as your license otherwise remains in force. You may convey covered works to others for the sole purpose of having them make modifications exclusively for you, or provide you with facilities for running those works, provided that you comply with the terms of this License in conveying all material for which you do not control copyright. Those thus making or running the covered works for you must do so exclusively on your behalf, under your direction and control, on terms that prohibit them from making any copies of your copyrighted material outside their relationship with you.

Conveying under any other circumstances is permitted solely under

the conditions stated below. Sublicensing is not allowed; section 10 makes it unnecessary.

3. Protecting Users' Legal Rights From Anti-Circumvention Law.

No covered work shall be deemed part of an effective technological measure under any applicable law fulfilling obligations under article 11 of the WIPO copyright treaty adopted on 20 December 1996, or similar laws prohibiting or restricting circumvention of such measures.

When you convey a covered work, you waive any legal power to forbid circumvention of technological measures to the extent such circumvention is effected by exercising rights under this License with respect to the covered work, and you disclaim any intention to limit operation or modification of the work as a means of enforcing, against the work's users, your or third parties' legal rights to forbid circumvention of technological measures.

4. Conveying Verbatim Copies.

You may convey verbatim copies of the Program's source code as you receive it, in any medium, provided that you conspicuously and appropriately publish on each copy an appropriate copyright notice; keep intact all notices stating that this License and any

non-permissive terms added in accord with section 7 apply to the code; keep intact all notices of the absence of any warranty; and give all recipients a copy of this License along with the Program.

You may charge any price or no price for each copy that you convey, and you may offer support or warranty protection for a fee.

5. Conveying Modified Source Versions.

You may convey a work based on the Program, or the modifications to produce it from the Program, in the form of source code under the terms of section 4, provided that you also meet all of these conditions:

a) The work must carry prominent notices stating that you modified it, and giving a relevant date.

b) The work must carry prominent notices stating that it is released under this License and any conditions added under section 7. This requirement modifies the requirement in section 4 to "keep intact all notices".

c) You must license the entire work, as a whole, under this License to anyone who comes into possession of a copy. This License will therefore apply, along with any applicable section 7 additional terms, to the whole of the work, and all its parts,

regardless of how they are packaged. This License gives no permission to license the work in any other way, but it does not invalidate such permission if you have separately received it.

d) If the work has interactive user interfaces, each must display Appropriate Legal Notices; however, if the Program has interactive interfaces that do not display Appropriate Legal Notices, your work need not make them do so.

A compilation of a covered work with other separate and independent works, which are not by their nature extensions of the covered work, and which are not combined with it such as to form a larger program, in or on a volume of a storage or distribution medium, is called an "aggregate" if the compilation and its resulting copyright are not used to limit the access or legal rights of the compilation's users beyond what the individual works permit. Inclusion of a covered work in an aggregate does not cause this License to apply to the other parts of the aggregate.

6. Conveying Non-Source Forms.

You may convey a covered work in object code form under the terms of sections 4 and 5, provided that you also convey the machine-readable Corresponding Source under the terms of this License, in one of these ways:

a) Convey the object code in, or embodied in, a physical product (including a physical distribution medium), accompanied by the Corresponding Source fixed on a durable physical medium customarily used for software interchange.

b) Convey the object code in, or embodied in, a physical product (including a physical distribution medium), accompanied by a written offer, valid for at least three years and valid for as long as you offer spare parts or customer support for that product model, to give anyone who possesses the object code either (1) a copy of the Corresponding Source for all the software in the product that is covered by this License, on a durable physical medium customarily used for software interchange, for a price no more than your reasonable cost of physically performing this conveying of source, or (2) access to copy the Corresponding Source from a network server at no charge.

c) Convey individual copies of the object code with a copy of the written offer to provide the Corresponding Source. This alternative is allowed only occasionally and noncommercially, and only if you received the object code with such an offer, in accord with subsection 6b.

d) Convey the object code by offering access from a designated place (gratis or for a charge), and offer equivalent access to the

Corresponding Source in the same way through the same place at no further charge. You need not require recipients to copy the Corresponding Source along with the object code. If the place to copy the object code is a network server, the Corresponding Source may be on a different server (operated by you or a third party) that supports equivalent copying facilities, provided you maintain clear directions next to the object code saying where to find the Corresponding Source. Regardless of what server hosts the Corresponding Source, you remain obligated to ensure that it is available for as long as needed to satisfy these requirements.

e) Convey the object code using peer-to-peer transmission, provided you inform other peers where the object code and Corresponding Source of the work are being offered to the general public at no charge under subsection 6d.

A separable portion of the object code, whose source code is excluded from the Corresponding Source as a System Library, need not be included in conveying the object code work.

A "User Product" is either (1) a "consumer product", which means any tangible personal property which is normally used for personal, family, or household purposes, or (2) anything designed or sold for incorporation into a dwelling. In determining whether a product is a consumer product, doubtful cases shall be resolved in favor of coverage. For a particular

product received by a particular user, "normally used" refers to a typical or common use of that class of product, regardless of the status of the particular user or of the way in which the particular user actually uses, or expects or is expected to use, the product. A product is a consumer product regardless of whether the product has substantial commercial, industrial or non-consumer uses, unless such uses represent the only significant mode of use of the product.

"Installation Information" for a User Product means any methods, procedures, authorization keys, or other information required to install and execute modified versions of a covered work in that User Product from a modified version of its Corresponding Source. The information must suffice to ensure that the continued functioning of the modified object code is in no case prevented or interfered with solely because modification has been made.

If you convey an object code work under this section in, or with, or specifically for use in, a User Product, and the conveying occurs as part of a transaction in which the right of possession and use of the User Product is transferred to the recipient in perpetuity or for a fixed term (regardless of how the transaction is characterized), the Corresponding Source conveyed under this section must be accompanied by the Installation Information. But this requirement does not apply if neither you nor any third party retains the ability to install modified object code on the User Product (for example, the work has

been installed in ROM).

The requirement to provide Installation Information does not include a requirement to continue to provide support service, warranty, or updates for a work that has been modified or installed by the recipient, or for the User Product in which it has been modified or installed. Access to a network may be denied when the modification itself materially and adversely affects the operation of the network or violates the rules and protocols for communication across the network.

Corresponding Source conveyed, and Installation Information provided, in accord with this section must be in a format that is publicly documented (and with an implementation available to the public in source code form), and must require no special password or key for unpacking, reading or copying.

7. Additional Terms.

"Additional permissions" are terms that supplement the terms of this License by making exceptions from one or more of its conditions.

Additional permissions that are applicable to the entire Program shall be treated as though they were included in this License, to the extent that they are valid under applicable law. If additional permissions apply only to part of the Program, that part may be used separately under those permissions, but the entire Program remains governed by

this License without regard to the additional permissions.

When you convey a copy of a covered work, you may at your option remove any additional permissions from that copy, or from any part of it. (Additional permissions may be written to require their own removal in certain cases when you modify the work.) You may place additional permissions on material, added by you to a covered work, for which you have or can give appropriate copyright permission.

Notwithstanding any other provision of this License, for material you add to a covered work, you may (if authorized by the copyright holders of that material) supplement the terms of this License with terms:

a) Disclaiming warranty or limiting liability differently from the terms of sections 15 and 16 of this License; or

b) Requiring preservation of specified reasonable legal notices or author attributions in that material or in the Appropriate Legal Notices displayed by works containing it; or

c) Prohibiting misrepresentation of the origin of that material, or requiring that modified versions of such material be marked in reasonable ways as different from the original version; or

d) Limiting the use for publicity purposes of names of licensors or

authors of the material; or

e) Declining to grant rights under trademark law for use of some trade names, trademarks, or service marks; or

f) Requiring indemnification of licensors and authors of that material by anyone who conveys the material (or modified versions of it) with contractual assumptions of liability to the recipient, for any liability that these contractual assumptions directly impose on those licensors and authors.

All other non-permissive additional terms are considered "further restrictions" within the meaning of section 10. If the Program as you received it, or any part of it, contains a notice stating that it is governed by this License along with a term that is a further restriction, you may remove that term. If a license document contains a further restriction but permits relicensing or conveying under this License, you may add to a covered work material governed by the terms of that license document, provided that the further restriction does not survive such relicensing or conveying.

If you add terms to a covered work in accord with this section, you must place, in the relevant source files, a statement of the additional terms that apply to those files, or a notice indicating where to find the applicable terms.

Additional terms, permissive or non-permissive, may be stated in the form of a separately written license, or stated as exceptions; the above requirements apply either way.

8. Termination.

You may not propagate or modify a covered work except as expressly provided under this License. Any attempt otherwise to propagate or modify it is void, and will automatically terminate your rights under this License (including any patent licenses granted under the third paragraph of section 11).

However, if you cease all violation of this License, then your license from a particular copyright holder is reinstated (a) provisionally, unless and until the copyright holder explicitly and finally terminates your license, and (b) permanently, if the copyright holder fails to notify you of the violation by some reasonable means prior to 60 days after the cessation.

Moreover, your license from a particular copyright holder is reinstated permanently if the copyright holder notifies you of the violation by some reasonable means, this is the first time you have received notice of violation of this License (for any work) from that copyright holder, and you cure the violation prior to 30 days after

your receipt of the notice.

Termination of your rights under this section does not terminate the licenses of parties who have received copies or rights from you under this License. If your rights have been terminated and not permanently reinstated, you do not qualify to receive new licenses for the same material under section 10.

9. Acceptance Not Required for Having Copies.

You are not required to accept this License in order to receive or run a copy of the Program. Ancillary propagation of a covered work occurring solely as a consequence of using peer-to-peer transmission to receive a copy likewise does not require acceptance. However, nothing other than this License grants you permission to propagate or modify any covered work. These actions infringe copyright if you do not accept this License. Therefore, by modifying or propagating a covered work, you indicate your acceptance of this License to do so.

10. Automatic Licensing of Downstream Recipients.

Each time you convey a covered work, the recipient automatically receives a license from the original licensors, to run, modify and propagate that work, subject to this License. You are not responsible for enforcing compliance by third parties with this License.

An "entity transaction" is a transaction transferring control of an organization, or substantially all assets of one, or subdividing an organization, or merging organizations. If propagation of a covered work results from an entity transaction, each party to that transaction who receives a copy of the work also receives whatever licenses to the work the party's predecessor in interest had or could give under the previous paragraph, plus a right to possession of the Corresponding Source of the work from the predecessor in interest, if the predecessor has it or can get it with reasonable efforts.

You may not impose any further restrictions on the exercise of the rights granted or affirmed under this License. For example, you may not impose a license fee, royalty, or other charge for exercise of rights granted under this License, and you may not initiate litigation (including a cross-claim or counterclaim in a lawsuit) alleging that any patent claim is infringed by making, using, selling, offering for sale, or importing the Program or any portion of it.

11. Patents.

A "contributor" is a copyright holder who authorizes use under this License of the Program or a work on which the Program is based. The work thus licensed is called the contributor's "contributor version".

A contributor's "essential patent claims" are all patent claims

owned or controlled by the contributor, whether already acquired or hereafter acquired, that would be infringed by some manner, permitted by this License, of making, using, or selling its contributor version, but do not include claims that would be infringed only as a consequence of further modification of the contributor version. For purposes of this definition, "control" includes the right to grant patent sublicenses in a manner consistent with the requirements of this License.

Each contributor grants you a non-exclusive, worldwide, royalty-free patent license under the contributor's essential patent claims, to make, use, sell, offer for sale, import and otherwise run, modify and propagate the contents of its contributor version.

In the following three paragraphs, a "patent license" is any express agreement or commitment, however denominated, not to enforce a patent (such as an express permission to practice a patent or covenant not to sue for patent infringement). To "grant" such a patent license to a party means to make such an agreement or commitment not to enforce a patent against the party.

If you convey a covered work, knowingly relying on a patent license, and the Corresponding Source of the work is not available for anyone to copy, free of charge and under the terms of this License, through a publicly available network server or other readily accessible means,

then you must either (1) cause the Corresponding Source to be so available, or (2) arrange to deprive yourself of the benefit of the patent license for this particular work, or (3) arrange, in a manner consistent with the requirements of this License, to extend the patent license to downstream recipients. "Knowingly relying" means you have actual knowledge that, but for the patent license, your conveying the covered work in a country, or your recipient's use of the covered work in a country, would infringe one or more identifiable patents in that country that you have reason to believe are valid.

If, pursuant to or in connection with a single transaction or arrangement, you convey, or propagate by procuring conveyance of, a covered work, and grant a patent license to some of the parties receiving the covered work authorizing them to use, propagate, modify or convey a specific copy of the covered work, then the patent license you grant is automatically extended to all recipients of the covered work and works based on it.

A patent license is "discriminatory" if it does not include within the scope of its coverage, prohibits the exercise of, or is conditioned on the non-exercise of one or more of the rights that are specifically granted under this License. You may not convey a covered work if you are a party to an arrangement with a third party that is in the business of distributing software, under which you make payment to the third party based on the extent of your activity of conveying

the work, and under which the third party grants, to any of the parties who would receive the covered work from you, a discriminatory patent license (a) in connection with copies of the covered work conveyed by you (or copies made from those copies), or (b) primarily for and in connection with specific products or compilations that contain the covered work, unless you entered into that arrangement, or that patent license was granted, prior to 28 March 2007.

Nothing in this License shall be construed as excluding or limiting any implied license or other defenses to infringement that may otherwise be available to you under applicable patent law.

12. No Surrender of Others' Freedom.

If conditions are imposed on you (whether by court order, agreement or otherwise) that contradict the conditions of this License, they do not excuse you from the conditions of this License. If you cannot convey a covered work so as to satisfy simultaneously your obligations under this License and any other pertinent obligations, then as a consequence you may not convey it at all. For example, if you agree to terms that obligate you to collect a royalty for further conveying from those to whom you convey the Program, the only way you could satisfy both those terms and this License would be to refrain entirely from conveying the Program.

13. Use with the GNU Affero General Public License

Notwithstanding any other provision of this License, you have permission to link or combine any covered work with a work licensed under version 3 of the GNU Affero General Public License into a single combined work, and to convey the resulting work. The terms of this License will continue to apply to the part which is the covered work, but the special requirements of the GNU Affero General Public License, section 13, concerning interaction through a network will apply to the combination as such.

14. Revised Versions of this License.

The Free Software Foundation may publish revised and/or new versions of the GNU General Public License from time to time. Such new versions will be similar in spirit to the present version, but may differ in detail to address new problems or concerns.

Each version is given a distinguishing version number. If the Program specifies that a certain numbered version of the GNU General Public License "or any later version" applies to it, you have the option of following the terms and conditions either of that numbered version or of any later version published by the Free Software Foundation. If the Program does not specify a version number of the GNU General Public License, you may choose any version ever published by the Free Software Foundation.

If the Program specifies that a proxy can decide which future versions of the GNU General Public License can be used, that proxy's public statement of acceptance of a version permanently authorizes you to choose that version for the Program.

Later license versions may give you additional or different permissions. However, no additional obligations are imposed on any author or copyright holder as a result of your choosing to follow a later version.

15. Disclaimer of Warranty.

THERE IS NO WARRANTY FOR THE PROGRAM, TO THE EXTENT PERMITTED BY APPLICABLE LAW. EXCEPT WHEN OTHERWISE STATED IN WRITING THE COPYRIGHT HOLDERS AND/OR OTHER PARTIES PROVIDE THE PROGRAM "AS IS" WITHOUT WARRANTY OF ANY KIND, EITHER EXPRESSED OR IMPLIED, INCLUDING, BUT NOT LIMITED TO, THE IMPLIED WARRANTIES OF MERCHANTABILITY AND FITNESS FOR A PARTICULAR PURPOSE. THE ENTIRE RISK AS TO THE QUALITY AND PERFORMANCE OF THE PROGRAM IS WITH YOU. SHOULD THE PROGRAM PROVE DEFECTIVE, YOU ASSUME THE COST OF ALL NECESSARY SERVICING, REPAIR OR CORRECTION.

16. Limitation of Liability.

IN NO EVENT UNLESS REQUIRED BY APPLICABLE LAW OR AGREED TO IN WRITING WILL ANY COPYRIGHT HOLDER, OR ANY OTHER PARTY WHO MODIFIES AND/OR CONVEYS

THE PROGRAM AS PERMITTED ABOVE, BE LIABLE TO YOU FOR DAMAGES, INCLUDING ANY GENERAL, SPECIAL, INCIDENTAL OR CONSEQUENTIAL DAMAGES ARISING OUT OF THE USE OR INABILITY TO USE THE PROGRAM (INCLUDING BUT NOT LIMITED TO LOSS OF DATA OR DATA BEING RENDERED INACCURATE OR LOSSES SUSTAINED BY YOU OR THIRD PARTIES OR A FAILURE OF THE PROGRAM TO OPERATE WITH ANY OTHER PROGRAMS), EVEN IF SUCH HOLDER OR OTHER PARTY HAS BEEN ADVISED OF THE POSSIBILITY OF SUCH DAMAGES.

17. Interpretation of Sections 15 and 16.

If the disclaimer of warranty and limitation of liability provided above cannot be given local legal effect according to their terms, reviewing courts shall apply local law that most closely approximates an absolute waiver of all civil liability in connection with the Program, unless a warranty or assumption of liability accompanies a copy of the Program in return for a fee.

END OF TERMS AND CONDITIONS

How to Apply These Terms to Your New Programs

If you develop a new program, and you want it to be of the greatest possible use to the public, the best way to achieve this is to make it free software which everyone can redistribute and change under these terms.

To do so, attach the following notices to the program. It is safest to attach them to the start of each source file to most effectively state the exclusion of warranty; and each file should have at least the "copyright" line and a pointer to where the full notice is found.

<one line to give the program's name and a brief idea of what it does.>

Copyright (C) <year> <name of author>

This program is free software: you can redistribute it and/or modify it under the terms of the GNU General Public License as published by the Free Software Foundation, either version 3 of the License, or (at your option) any later version.

This program is distributed in the hope that it will be useful, but WITHOUT ANY WARRANTY; without even the implied warranty of MERCHANTABILITY or FITNESS FOR A PARTICULAR PURPOSE. See the GNU General Public License for more details.

You should have received a copy of the GNU General Public License along with this program. If not, see <<http://www.gnu.org/licenses/>>.

Also add information on how to contact you by electronic and paper mail.

If the program does terminal interaction, make it output a short notice like this when it starts in an interactive mode:

<program> Copyright (C) <year> <name of author>

This program comes with ABSOLUTELY NO WARRANTY; for details type `show w'.

This is free software, and you are welcome to redistribute it
under certain conditions; type `show c' for details.

The hypothetical commands `show w' and `show c' should show the appropriate parts of the General Public License. Of course, your program's commands might be different; for a GUI interface, you would use an "about box".

You should also get your employer (if you work as a programmer) or school, if any, to sign a "copyright disclaimer" for the program, if necessary.

For more information on this, and how to apply and follow the GNU GPL, see
<<http://www.gnu.org/licenses/>>.

The GNU General Public License does not permit incorporating your program into proprietary programs. If your program is a subroutine library, you may consider it more useful to permit linking proprietary applications with the library. If this is what you want to do, use the GNU Lesser General Public License instead of this License. But first, please read
<<http://www.gnu.org/philosophy/why-not-lgpl.html>>.

GNU LESSER GENERAL PUBLIC LICENSE

Version 3, 29 June 2007

Copyright (C) 2007 Free Software Foundation, Inc. <<http://fsf.org/>>

Everyone is permitted to copy and distribute verbatim copies

of this license document, but changing it is not allowed.

This version of the GNU Lesser General Public License incorporates the terms and conditions of version 3 of the GNU General Public License, supplemented by the additional permissions listed below.

0. Additional Definitions.

As used herein, "this License" refers to version 3 of the GNU Lesser General Public License, and the "GNU GPL" refers to version 3 of the GNU General Public License.

"The Library" refers to a covered work governed by this License, other than an Application or a Combined Work as defined below.

An "Application" is any work that makes use of an interface provided by the Library, but which is not otherwise based on the Library. Defining a subclass of a class defined by the Library is deemed a mode of using an interface provided by the Library.

A "Combined Work" is a work produced by combining or linking an Application with the Library. The particular version of the Library with which the Combined Work was made is also called the "Linked Version".

The "Minimal Corresponding Source" for a Combined Work means the

Corresponding Source for the Combined Work, excluding any source code for portions of the Combined Work that, considered in isolation, are based on the Application, and not on the Linked Version.

The "Corresponding Application Code" for a Combined Work means the object code and/or source code for the Application, including any data and utility programs needed for reproducing the Combined Work from the Application, but excluding the System Libraries of the Combined Work.

1. Exception to Section 3 of the GNU GPL.

You may convey a covered work under sections 3 and 4 of this License without being bound by section 3 of the GNU GPL.

2. Conveying Modified Versions.

If you modify a copy of the Library, and, in your modifications, a facility refers to a function or data to be supplied by an Application that uses the facility (other than as an argument passed when the facility is invoked), then you may convey a copy of the modified version:

- a) under this License, provided that you make a good faith effort to ensure that, in the event an Application does not supply the function or data, the facility still operates, and performs

whatever part of its purpose remains meaningful, or

b) under the GNU GPL, with none of the additional permissions of this License applicable to that copy.

3. Object Code Incorporating Material from Library Header Files.

The object code form of an Application may incorporate material from a header file that is part of the Library. You may convey such object code under terms of your choice, provided that, if the incorporated material is not limited to numerical parameters, data structure layouts and accessors, or small macros, inline functions and templates (ten or fewer lines in length), you do both of the following:

a) Give prominent notice with each copy of the object code that the Library is used in it and that the Library and its use are covered by this License.

b) Accompany the object code with a copy of the GNU GPL and this license document.

4. Combined Works.

You may convey a Combined Work under terms of your choice that, taken together, effectively do not restrict modification of the

portions of the Library contained in the Combined Work and reverse engineering for debugging such modifications, if you also do each of the following:

a) Give prominent notice with each copy of the Combined Work that the Library is used in it and that the Library and its use are covered by this License.

b) Accompany the Combined Work with a copy of the GNU GPL and this license document.

c) For a Combined Work that displays copyright notices during execution, include the copyright notice for the Library among these notices, as well as a reference directing the user to the copies of the GNU GPL and this license document.

d) Do one of the following:

0) Convey the Minimal Corresponding Source under the terms of this License, and the Corresponding Application Code in a form suitable for, and under terms that permit, the user to recombine or relink the Application with a modified version of the Linked Version to produce a modified Combined Work, in the manner specified by section 6 of the GNU GPL for conveying Corresponding Source.

1) Use a suitable shared library mechanism for linking with the Library. A suitable mechanism is one that (a) uses at run time a copy of the Library already present on the user's computer system, and (b) will operate properly with a modified version of the Library that is interface-compatible with the Linked Version.

e) Provide Installation Information, but only if you would otherwise be required to provide such information under section 6 of the GNU GPL, and only to the extent that such information is necessary to install and execute a modified version of the Combined Work produced by recombining or relinking the Application with a modified version of the Linked Version. (If you use option 4d0, the Installation Information must accompany the Minimal Corresponding Source and Corresponding Application Code. If you use option 4d1, you must provide the Installation Information in the manner specified by section 6 of the GNU GPL for conveying Corresponding Source.)

5. Combined Libraries.

You may place library facilities that are a work based on the Library side by side in a single library together with other library facilities that are not Applications and are not covered by this License, and convey such a combined library under terms of your

choice, if you do both of the following:

a) Accompany the combined library with a copy of the same work based on the Library, uncombined with any other library facilities, conveyed under the terms of this License.

b) Give prominent notice with the combined library that part of it is a work based on the Library, and explaining where to find the accompanying uncombined form of the same work.

6. Revised Versions of the GNU Lesser General Public License.

The Free Software Foundation may publish revised and/or new versions of the GNU Lesser General Public License from time to time. Such new versions will be similar in spirit to the present version, but may differ in detail to address new problems or concerns.

Each version is given a distinguishing version number. If the Library as you received it specifies that a certain numbered version of the GNU Lesser General Public License "or any later version" applies to it, you have the option of following the terms and conditions either of that published version or of any later version published by the Free Software Foundation. If the Library as you received it does not specify a version number of the GNU Lesser General Public License, you may choose any version of the GNU Lesser

General Public License ever published by the Free Software Foundation.

If the Library as you received it specifies that a proxy can decide whether future versions of the GNU Lesser General Public License shall apply, that proxy's public statement of acceptance of any version is permanent authorization for you to choose that version for the Library.



EAW

Eastern Acoustic Works

19 National Drive | Franklin, MA 02038

USA tel 800 992 5013 / +1 508 234 6158

www.eaw.com

©2025 Eastern Acoustic Works

All rights reserved. Products are not drawn to scale.

All terms, conditions, and specifications subject to change without notice.