



**MADER®**



**TRABALHA COMO  
UM PROFISSIONAL**

**MADER®**

**GARDEN  
TOOLS**

**ÍNDICE - PARTE I****MÁQUINAS / MÁQUINAS / MACHINES**

- BATERIA / BATERÍA / BATTERY  
MOTOR ELÉTRICO / ELECTRIC ENGINE  
MOTOR EXPLOSÃO / MOTOR DE EXPLOSIÓN / EXPLOSION ENGINE
- MÁQUINA RELVA / CORTACÉSPED / LAWN MOWER
- ABRE BURACOS / TALADRO DE TIERRA / GROUND AUGER
- MOTOCULTIVADOR / ARADO MECÁNICO / TILLER
- APARADOR RELVA / CORTABORDES / GRASS TRIMMER
- ROÇADOURA / DESBROZADORA / BRUSH CUTTER
- VAREJADOR AZEITONA / VAREADOR DE OLIVAS / OLIVE SHAKER
- PODADORA DE ALTURA / ENGINE POWERED PRUNER
- CORTA SEBES / CORTASETOS / HEDGE TRIMMER
- MOTOSSERRA / MOTOSIERRA / CHAIN SAW
- AFIADOR CORRENTE / AFILADOR DE CADENA / CHAIN SAW SHARPENER
- MÁQUINA RACHAR LENHA / TRONZADORA DE LEÑA / LOG SPLITTER
- TRITURADOR JARDIM / CORTADOR DE JARDÍN / CHIPPER SHREDDER
- SOPRADOR-ASPIRADOR / SOPLADOR-ASPIRADOR / BLOWER

**ÍNDICE - PARTE II****BOMBAS / PUMPS**

- BOMBA SUBMERSÍVEL / BOMBA DRENAJE SUMERGIBLE / SUBMERSIBLE PUMP
- ÁGUAS LIMPAS / AGUAS LIMPIAS / CLEAN WATER
- ÁGUAS SUJAS / AGUAS SÚCIAS / DIRTY WATER
- ELETROBOMBA / BOMBA ELÉCTRICA / ELECTRIC PUMP
- MOTOBOMBA / MOTOBOMBA / WATER PUMP
- SULFATADOR / MIST DUSTER
- ATOMIZADOR / POWER SPRAYER
- PULVERIZADOR / SPRAYER

**ACESSÓRIOS REGA / ACCESORIOS DE RIEGO / WATERING ACCESSORIES**

- ACESSÓRIO CLIC / ACCESORIO CLIC / CLIC ACCESSORY
- AGULHETA / LANZA RIEGO / SPRAY NOZZLE
- ASPERSOR / SPRINKLER
- TEMPORIZADOR REGA / PROGRAMADOR DE RIEGO / TAP TIMER
- MANGUEIRA / MANGUERA / HOSE
- SUPORTE / SOPORTE / HANGER

**FERRAMENTA MANUAL / HERRAMIENTAS MANUAL / HAND TOOL**

- VASSOURA / ESCOBA CÉSPED / GRASS BROOM
- SACHO E ENXADA / AZADA / WEEDING HOE AND HOE
- PÁ / PALOTE / SHOVEL
- SERROTE / SERRUCHO / SAW
- MACHADO / HACHA / AXE
- TESOURA / PODADERA / PRUNING SHEAR

**CAMPISMO / CAMPING**

- CANDEIEIRO / LÂMPARA / LAMP
- FOGAREIRO / HORNILLO / STOVE

**DIVERSOS / MISCELLANEOUS**

Este catálogo apresenta a nossa gama atual. Mudanças no fabrico, forma, design e descrições dos artigos são atualizadas constantemente e pode ser verificado pela versão indicada na pág. Fotos, descrições e especificações técnicas foram reproduzidas com a maior exatidão possível, sendo possíveis pequenas alterações do original. Os preços constantes no catálogo podem ser alterados sem aviso prévio, devido a alterações de características, aumentos na origem ou diferenças cambiais

Este catálogo presenta nuestra gama actual. Los cambios en la fabricación, los diseños y las descripciones de los artículos se actualizan constantemente y se pueden comprobar en la versión indicada en la pag. . Fotos, descripciones y especificaciones técnicas han sido reproducidos con la máxima exactitud, siendo posibles pequeños cambios en el original. Los precios en el catálogo pueden cambiar sin previo aviso debido a cambios en las características, aumentos en el origen o diferencias cambial.

**MÁQUINA DE CORTE DE RELVA**  
CORTACÉSPED  
LAWN MOWER

**ALAVANCA CENTRAL**  
PALANCA CENTRAL  
CENTRAL LEVER

**INDUÇÃO**  
INDUCCIÓN  
INDUCTION

**CESTO SEMI RÍGIDO**  
- TÊXTIL E PLÁSTICO  
CESTA SEMIRRÍGIDA  
- TEXTIL Y PLÁSTICO  
SEMI RIGID BASKET  
- TEXTILE AND PLASTIC



57221



5602225572215

**1600 W**

380 mm

<b>RPM</b>	<b>3000</b>
<b>Tensão / Tensión / Voltage</b>	<b>230V ~ 50Hz</b>
<b>Corte (Altura) / Cut (Height)</b>	<b>5 - (20 » 65 mm)</b>
<b>Descarga / Discharge</b>	<b>Traseira</b>
<b>Cesto / Recogedor / Collection Bag</b>	<b>50 L</b>
<b>Roda / Rueda / Wheel</b>	<b>Ø 145mm x 2 + Ø 170mm x 2</b>
<b>Ruído / Noise</b>	<b>96 dB (A)</b>

**CARCAÇA EM POLIPROPILENO**  
ARMAZÓN EN POLIPROPILENO  
POLYPROPYLENE BODY

**< 500 m<sup>2</sup>**  
Area | Superfície (max.)

N. Ref.	Descrição	Marca	Quant. Caixa
57221	MAQ RELVA ELE-MGD-1600W	MADER GARDEN TOOLS	1/1

**RODA » MÁQUINA DE RELVA**  
RUEDA » CORTACÉSPED  
WHEEL » LAWN MOWER



57234

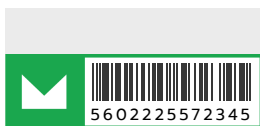

5602225572345

**6" - 150mm**

**Adaptadores para vários diâmetros de veio**  
Adaptadores para varios diámetros de eje  
Adapters for various shaft diameters

N. Ref.	Descrição	Marca	Quant. Caixa
57234	RODA 250MM -MGD-P/MAQ RELVA	MADER GARDEN TOOLS	50



**MÁQUINA DE CORTE DE RELVA**  
CORTACÉSPED  
LAWN MOWER

**ALAVANCA CENTRAL**  
PALANCA CENTRAL  
CENTRAL LEVER



**CESTO RÍGIDO - PLÁSTICO**  
CESTA RÍGIDA - PLÁSTICO  
RIGID BASKET - PLASTIC



**1800 W**

420 mm

<b>RPM</b>	<b>3450</b>
<b>Tensão / Tensión / Voltage</b>	<b>230V ~ 50Hz</b>
<b>Corte (Altura) / Cut (Height)</b>	<b>5 - (25 » 80 mm)</b>
<b>Descarga / Discharge</b>	<b>Traseira</b>
<b>Cesto / Recogedor / Collection Bag</b>	<b>40 L</b>
<b>Roda / Rueda / Wheel</b>	<b>Ø 145mm x 2 + Ø 220mm x 2</b>
<b>Ruido / Noise</b>	<b>96 dB (A)</b>

**CARCAÇA EM POLIPROPILENO**  
ARMAZÓN EN POLIPROPILENO  
POLYPROPYLENE BODY

**< 800 m<sup>2</sup>**  
Area | Superfície (max.)

N. Ref.	Descrição	Marca	Quant. Caixa
57224	MAQ RELVA ELE-MGD-1800W	MADER GARDEN TOOLS	1/1



**MÁQUINA DE CORTE DE RELVA**  
CORTACÉSPED  
LAWN MOWER

**TRAÇÃO**  
TRACIÓN  
TRACTION



**ALAVANCA CENTRAL**  
PALANCA CENTRAL  
CENTRAL LEVER

**CESTO FLEXÍVEL - TÊXTEL**  
CESTA FLEXIBLE - TEXTIL  
FLEXIBLE BASKET - TEXTILE

**CARCAÇA EM METAL**  
ARMAZÓN EN METAL  
METAL BODY



**139 cc**  
460 mm

<b>Potência</b> / Potencia / Power	<b>3.0 kW</b>
<b>RPM</b>	<b>3000</b>
<b>Corte (Altura)</b> / Cut (Height)	<b>5 - (25 » 75 mm)</b>
<b>Descarga</b> / Discharge	<b>Traseira</b>
<b>Cesto</b> / Recogedor / Collection Bag	<b>55 L</b>
<b>Roda</b> / Rueda / Wheel	<b>Ø 175mm x 2 + Ø 200mm x 2</b>
<b>Ruído</b> / Noise	<b>96 dB (A)</b>
<b>Cárter</b> / Crankcase	<b>0.5L (10W40 / 15W40 / SAE30)</b>

N. Ref.	Descrição	Marca	Quant. Caixa
57422	MAQ RELVA-MGD-139CC 4HP 3KW	MADER GARDEN TOOLS	1/1

**4T - Gasolina 95**  
4S - Gasoline 95

**Óleo (não incluído)**  
Aceite (no incluido)  
Oil (not included)

**10W40 - Ref. 25203 - 1L**



**< 1000 m2**  
Area | Superfície (max.)

## MÁQUINA DE CORTE DE RELVA CORTACÉSPED LAWN MOWER

Descarga 3 IN 1  
Traseira, Lateral e Mulching



**TRAÇÃO**  
TRACIÓN  
TRACTION

**ALAVANCA CENTRAL**  
PALANCA CENTRAL  
CENTRAL LEVER

**CESTO SEMI RÍGIDO**  
- TÊXTEL E PLÁSTICO  
CESTA SEMIRRÍGIDA  
- TEXTIL Y PLÁSTICO  
SEMI RIGID BASKET  
- TEXTILE AND PLASTIC

**CARCAÇA EM METAL**  
ARMAZÓN EN METAL  
METAL BODY

**CARCAÇA - Lavagem c/ Ligação Clic**  
ARMAZÓN - Lavado con Conexión Click  
METAL BODY - Washing with Click Connection



**161 cc**  
525 mm

Potência / Potencia / Power	2.8 kW
RPM	2800
Corte (Altura) / Cut (Height)	7 - (25 » 75 mm)
Descarga / Discharge	Traseira, Lateral e Mulching
Cesto / Recogedor / Collection Bag	70 L
Roda / Rueda / Wheel	Ø 200mm x 2 + Ø 250mm x 2
Ruído / Noise	98 dB (A)
Cárter / Crankcase	0.5L (10W40 / 15W40 / SAE30)

N. Ref.	Descrição	Marca	Quant. Caixa
57423	MAQ RELVA-MGD-C/T 161CC B&S 53	MADER GARDEN TOOLS	1/1



**4T - Gasolina 95**  
**4S - Gasoline 95**  
**BRIGGS & STRATTON**

**Óleo (não incluído)**  
Aceite (no incluido)  
Oil (not included)

**10W40 - Ref. 25203 - 1L**



**< 2000 m2**  
Area | Superfície (max.)

**MÁQUINA DE CORTE DE RELVA**  
CORTACÉSPED  
LAWN MOWER

**Descarga**  
**Traseira + Lateral**

**TRAÇÃO**  
TRACIÓN  
TRACTION



**ALAVANCA CENTRAL**  
PALANCA CENTRAL  
CENTRAL LEVER

**CESTO SEMI RÍGIDO**  
- TÊXTIL E PLÁSTICO  
CESTA SEMIRRÍGIDA  
- TEXTIL Y PLÁSTICO  
SEMI RIGID BASKET  
- TEXTILE AND PLASTIC

**CARCAÇA EM METAL**  
ARMAZÓN EN METAL  
METAL BODY



**173 cc**  
510 mm

<b>Potência / Potencia / Power</b>	<b>4.5 kW</b>
<b>RPM</b>	<b>2800</b>
<b>Corte (Altura) / Cut (Height)</b>	<b>7 - (20 » 75mm)</b>
<b>Descarga / Discharge</b>	<b>Traseira e Lateral</b>
<b>Cesto / Recogedor / Collection Bag</b>	<b>60 L</b>
<b>Roda / Rueda / Wheel</b>	<b>Ø 175mm x 2 + Ø 250mm x 2</b>
<b>Ruído / Noise</b>	<b>98 dB (A)</b>
<b>Cárter / Crankcase</b>	<b>0.5L (10W40 / 15W40 / SAE30)</b>

**4T - Gasolina 95**  
4S - Gasoline 95

**Óleo (não incluído)**  
Aceite (no incluido)  
Oil (not included)

**10W40 - Ref. 25203 - 1L**

**< 2000 m2**  
Area | Superfície (max.)



N. Ref.	Descrição	Marca	Quant. Caixa
57421	MAQ RELVA-MGD-173CC C/T 510MM	MADER GARDEN TOOLS	1/1

**MÁQUINA DE CORTE DE RELVA**  
CORTACÉSPED  
LAWN MOWER

**TRAÇÃO**  
TRACIÓN  
TRACTION

**ALAVANCA CENTRAL**  
PALANCA CENTRAL  
CENTRAL LEVER

**CESTO SEMI RÍGIDO**  
- TÊXTIL E PLÁSTICO  
CESTA SEMIRRÍGIDA  
- TEXTIL Y PLÁSTICO  
SEMI RIGID BASKET  
- TEXTILE AND PLASTIC

**CARCAÇA EM METAL**  
ARMAZÓN EN METAL  
METAL BODY

**CARCAÇA - Lavagem c/ Ligaçao Clic**  
ARMAZÓN - Lavado con Conexión Click  
METAL BODY - Washing with Click Connection

**Descarga 3 IN 1**  
Traseira, Lateral e Mulching



**196 cc**  
525 mm

<b>Potência / Potencia / Power</b>	<b>4.4 kW</b>
<b>RPM</b>	<b>2800</b>
<b>Corte (Altura) / Cut (Height)</b>	<b>7 - (25 » 75mm)</b>
<b>Descarga / Discharge</b>	<b>Traseira, Lateral e Mulching</b>
<b>Cesto / Recogedor / Collection Bag</b>	<b>70 L</b>
<b>Roda / Rueda / Wheel</b>	<b>Ø 200mm x 2 + Ø 270mm x 2</b>
<b>Ruído / Noise</b>	<b>98 dB (A)</b>
<b>Cárter / Crankcase</b>	<b>0.5L (10W40 / 15W40 / SAE30)</b>

**4T - Gasolina 95**  
4S - Gasoline 95

**Óleo (não incluído)**  
Aceite (no incluido)  
Oil (not included)

**10W40 - Ref. 25203 - 1L**

**< 2000 m2**  
Area | Superficie (max.)



N. Ref.	Descrição	Marca	Quant. Caixa
57424	MAQ RELVA-MGD-C/T 196CC 530MM	MADER GARDEN TOOLS	1/1



**TRATOR DE RELVA**  
**TRACTOR CORTACÉSPED**  
**LAWN TRACTOR**

**ARRANQUE ELÉTRICO**  
**ARRANQUE ELÉCTRICO**  
**ELECTRIC START**

**Raio viragem: 450 mm**  
**Raio giro: 450 mm**  
**Turning radius: 450 mm**

**Caixa de Velocidades**  
**- Automática**  
**Caja Cambios - Automática**  
**Gearbox - Automatic**

**Lâmina Dupla**  
**Auto-Limpeza do Deck**  
**6 Níveis de Corte**

**Lâmina Doble**  
**Plataforma Autolimpiable**  
**6 Niveles de Corte**  
**Double Blade**  
**Deck Self-Cleaning**  
**6 Cutting Levels**



**17.5 hp**  
**1000 mm**

**< 5000 m2**  
**Area | Superfície (máx.)**

**Motor BRIGGS & STRATTON, 4175 EX**

**4T - Gasolina 95**  
**4S - Gasoline 95**

**1 Cilindro (ferro fundido)**  
**1 Cilindro (hierro fundido)**  
**1 Cast (iron sleeve)**

**Propulsão Hidrostática**  
**Tomada Força - PTO Elétrica**  
**Propulsión Hidrostática**  
**Tomada Fuerza - PTO Eléctrica**  
**Hydrostatic Propulsion**  
**Electric PTO**

**Chassi soldado**  
**Chasis soldado**  
**Welded chassis**

<b>Cilindrada / Desplazamiento / Cylinder Capacity</b>	<b>500 cc</b>
<b>Velocidade / Velocidad / Speed</b>	<b>"R" (4.5km/h) - "1" (8.8km/h)</b>
<b>Corte (Altura) / Cut (Height)</b>	<b>30 - 90 mm</b>
<b>Lâmina / Cuchilla / Blade</b>	<b>520 x 520 mm</b>
<b>Descarga / Discharge</b>	<b>Traseira</b>
<b>Plataforma / Platform</b>	<b>Aço</b>
<b>Roda / Rueda / Wheel</b>	<b>Frente: 15x6.00-6 (x2)</b> <b>Trás: 18x8.50-8 (x2)</b>
<b>Depósito Combustível / Depósito Combustible / Fuel Tank</b>	<b>7.5 L</b>
<b>Depósito Óleo / Depósito De Aceite / Oil Deposit</b>	<b>11 L</b>
<b>Ruído / Noise</b>	<b>100 dB(A)</b>
<b>Bateria / Bateria / battery</b>	<b>12V, 18A (180x85x165mm)</b>
<b>Luminosidade / Luminosidad / Brightness</b>	<b>Farol frontal de trabalho</b>
<b>Contém / Contiene / Contains</b>	<b>Porta-garrafa lateral</b>

N. Ref.	Descrição	Marca	Quant. Caixa
57251	TRATOR RELVA-MGD-17,5HP B&S	MADER GARDEN TOOLS	1

**MINI TRATOR**  
MINI TRACTOR  
MINI TRACTOR

**4\*4 WD** **GASOLINA**

**ARRANQUE ELÉTRICO**  
ARRANQUE ELÉCTRICO  
ELECTRIC START

**6 VELOCIDADES**  
6 GEARS

**(4x) Farol frontal de trabalho**  
(4x) Luz de trabajo frontal  
(4x) Front work light

**TOMADA FORÇA - PTO**  
TOMADA FUERZA - PTO  
POWER TAKE OFF - PTO

**ARTICULADO**  
ARTICULATED



**4T - Gasolina 95**  
**4S - Gasoline 95**

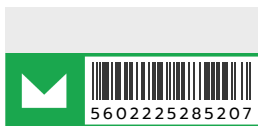

**457 cc**



**Oferta | Regalo | Offer**  
Arco de Proteção com Tapa Sol  
| Arco Protector con Tapa Sol  
| Protection Arch with Sunshade  
Ref 28578

<b>Potência / Potencia / Power</b>	<b>9.2 kW</b>
<b>RPM</b>	<b>3600</b>
<b>Transmissão / Transmisión / Transmission</b>	<b>4*4 WD</b>
<b>Velocidades / Marchas / Gears</b>	<b>6 - (R + R2 + 1 + 2 + 3 + 4)</b>
<b>Velocidade / Velocidad / Speed</b>	<b>(F) 12 Km/h - (R) 5 Km/h</b>
<b>Roda / Rueda / Wheel</b>	<b>(4x) 6.0 - 12</b>
<b>Ruído / Noise</b>	<b>109 dB(A)</b>

N. Ref.	Descrição	Marca	Quant. Caixa
28520	MINI TRATOR-MGD-457CC 6V GASOL	MADER GARDEN TOOLS	1/1
28578	ARCO PROTEÇÃO-MGD-C/TAPA SOL	MADER GARDEN TOOLS	1/1

# MADER®

# GARDEN TOOLS

**MINI TRATOR**  
MINI TRACTOR  
MINI TRACTOR

**ARTICULADO**  
ARTICULATED

**4\*4 WD** **GASOLINA**

**ARRANQUE ELÉTRICO**  
ARRANQUE ELÉCTRICO  
ELECTRIC START

**6 VELOCIDADES**  
6 GEARS

**TOMADA FORÇA - PTO**  
TOMADA FUERZA - PTO  
POWER TAKE OFF - PTO

**(4x) Farol frontal de trabalho**  
(4x) Luz de trabajo frontal  
(4x) Front work light

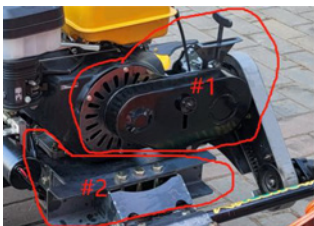
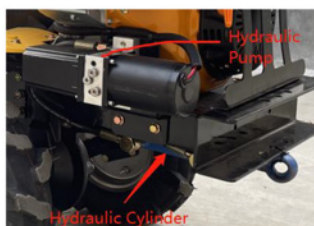

### Incluído | Incluído | Included

Corta Erva | Segadora | Herbs Cutter: **120cm**  
Ref 28572

Sistema Hidráulico Frontal  
| Front Hydraulic System  
Ref 28566

Encaixe de Transmissão  
| Toma de Transmisión | Transmission Fitting  
Ref 28567



**457 cc**

<b>Motor / Engine</b>	<b>4T - Gasolina 95</b>
<b>Potência / Potencia / Power</b>	<b>9.2 kW</b>
<b>RPM</b>	<b>3600</b>
<b>Transmissão / Transmisión / Transmission</b>	<b>4*4 WD</b>
<b>Velocidades / Marchas / Gears</b>	<b>6 - (R + R2 + 1 + 2 + 3 + 4)</b>
<b>Velocidade / Velocidad / Speed</b>	<b>(F) 12 Km/h - (R) 5 Km/h</b>
<b>Roda / Rueda / Wheel</b>	<b>(4x) 6.0 - 12</b>
<b>Ruído / Noise</b>	<b>109 dB(A)</b>

N. Ref.	Descrição	Marca	Quant. Caixa
28523	MINI TRATOR-MGD-457CC G C/CEIF	MADER GARDEN TOOLS	1/1
28572	CORTA ERVA-MGD-1200MM	MADER GARDEN TOOLS	1/1



### Oferta | Regalo | Offer

Arco de Proteção com Tapa Sol  
| Arco Protector con Tapa Sol  
| Protection Arch with Sunshade  
Ref 28578

**MADER**

**TRABALHA COMO UM PROFISSIONAL**

26APR06

**MINI TRATOR**  
MINI TRACTOR  
MINI TRACTOR

**4\*4 WD DIESEL**

**ARRANQUE ELÉTRICO**  
ARRANQUE ELÉCTRICO  
ELECTRIC START

**6 VELOCIDADES**  
6 GEARS

**TOMADA FORÇA - PTO**  
TOMADA FUERZA - PTO  
POWER TAKE OFF - PTO

**(4x) Farol frontal de trabalho**  
(4x) Luz de trabajo frontal  
(4x) Front work light

**ARTICULADO**  
ARTICULATED



**532 cc**

<b>Motor / Engine</b>	<b>Diesel</b>
<b>Potência / Potencia / Power</b>	<b>7.3 kW</b>
<b>RPM</b>	<b>3000</b>
<b>Transmissão / Transmisión / Transmission</b>	<b>4*4 WD</b>
<b>Velocidades / Marchas / Gears</b>	<b>6 - (R + R2 + 1 + 2 + 3 + 4)</b>
<b>Velocidade / Velocidad / Speed</b>	<b>(F) 12 Km/h - (R) 5 Km/h</b>
<b>Roda / Rueda / Wheel</b>	<b>(4x) 6.0 - 12</b>
<b>Ruído / Noise</b>	<b>109 dB(A)</b>

N. Ref.	Descrição	Marca	Quant. Caixa
28521	MINI TRATOR-MGD-532CC 6V DIESE	MADER GARDEN TOOLS	1/1
28578	ARCO PROTEÇÃO-MGD-C/TAPA SOL	MADER GARDEN TOOLS	1/1

**Oferta | Regalo | Offer**  
Arco de Proteção com Tapa Sol  
| Arco Protector con Tapa Sol  
| Protection Arch with Sunshade  
Ref 28578

# MADER®

# GARDEN TOOLS

**MINI TRATOR**  
MINI TRACTOR  
MINI TRACTOR

**ARTICULADO**  
ARTICULATED

**4\*4 WD DIESEL**

**ARRANQUE ELÉTRICO**  
ARRANQUE ELÉCTRICO  
ELECTRIC START

**6 VELOCIDADES**  
6 GEARS

**TOMADA FORÇA - PTO**  
TOMADA FUERZA - PTO  
POWER TAKE OFF - PTO

**(4x) Farol frontal de trabalho**  
(4x) Luz de trabajo frontal  
(4x) Front work light

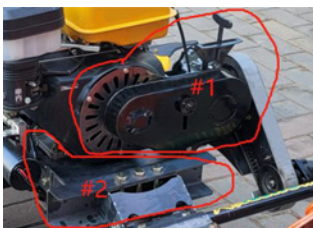
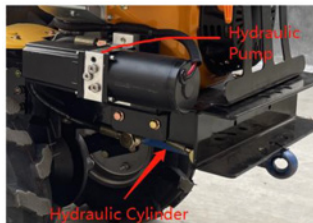

Incluído | Incluído | Included  
Corta Erva | Segadora | Herbs Cutter: 120cm  
Ref 28572  
Sistema Hidráulico Frontal | Front Hydraulic System  
Ref 28566  
Encaixe de Transmissão | Toma de Transmisión |  
Transmission Fitting  
Ref 28567



**532 cc**

<b>Motor / Engine</b>	<b>Diesel</b>
<b>Potência / Potencia / Power</b>	<b>7.3 kW</b>
<b>RPM</b>	<b>3000</b>
<b>Transmissão / Transmisión / Transmission</b>	<b>4*4 WD</b>
<b>Velocidades / Marchas / Gears</b>	<b>6 - (R + R2 + 1 + 2 + 3 + 4)</b>
<b>Velocidade / Velocidad / Speed</b>	<b>(F) 12 Km/h - (R) 5 Km/h</b>
<b>Roda / Rueda / Wheel</b>	<b>(4x) 6.0 - 12</b>
<b>Ruído / Noise</b>	<b>109 dB(A)</b>

N. Ref.	Descrição	Marca	Quant. Caixa
28524	MINI TRATOR-MGD-532CC D C/CEIF	MADER GARDEN TOOLS	1/1
28578	ARCO PROTEÇÃO-MGD-C/TAPA SOL	MADER GARDEN TOOLS	1/1



**Oferta | Regalo | Offer**  
Arco de Proteção com Tapa Sol  
| Arco Protector con Tapa Sol  
| Protection Arch with Sunshade  
Ref 28578

**MADER**

**TRABALHA COMO UM PROFISSIONAL**

26APR06

**CULTIVADOR**  
CULTIVADOR  
CULTIVADOR

**AJUSTÁVEL**  
AJUSTABLE  
ADJUSTABLE



**5 Linhas**  
5 Filas  
5 Rows

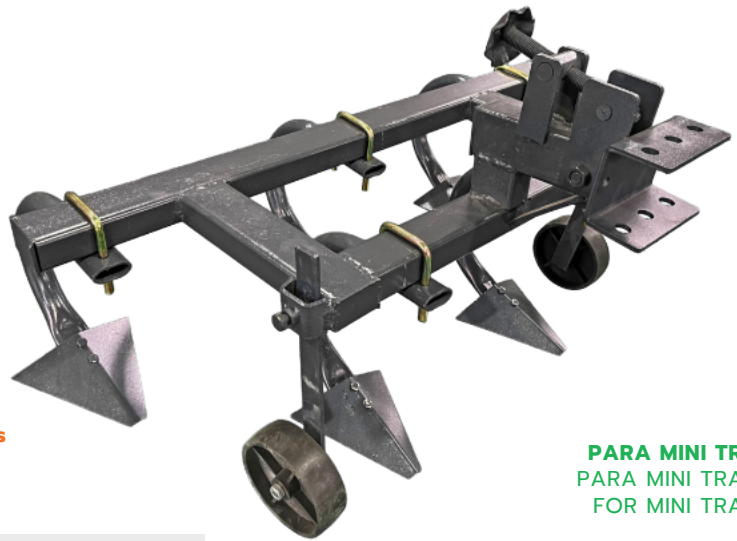

**PARA MINI TRATOR**  
PARA MINI TRACTOR  
FOR MINI TRACTOR

**Ref. 28520/28521**

N. Ref.	Descrição	Marca	Quant. Caixa
28568	CULTIVADOR-MGD-5 LINHAS AJUSTA	MADER GARDEN TOOLS	1/1

**ARRANCADOR BATATAS**  
COSECHADORA PATATAS  
POTATO HARVESTER

**DUPLO**  
DOBLE  
DOUBLE



**PARA MINI TRATOR**  
PARA MINI TRACTOR  
FOR MINI TRACTOR

**Ref. 28520/28521**

N. Ref.	Descrição	Marca	Quant. Caixa
28576	ARRANCAD BATATAS-MGD-DUPLO AJU	MADER GARDEN TOOLS	1/1

**ARRANCADOR BATATAS**  
COSECHADORA PATATAS  
POTATO HARVESTER

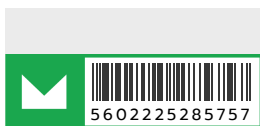

**600 mm**



**PARA MINI TRATOR**  
PARA MINI TRACTOR  
FOR MINI TRACTOR

**Ref. 28520/28521**

N. Ref.	Descrição	Marca	Quant. Caixa
28575	ARRANCADOR BATATAS-MGD-60CM	MADER GARDEN TOOLS	1/1

## CHARRUA VERTEDEIRA PLOUGH

**REVERSÍVEL**  
REVERSIBLE



**PARA MINI TRATOR**  
PARA MINI TRACTOR  
FOR MINI TRACTOR

**Ref. 28520/28521**

N. Ref.	Descrição	Marca	Quant. Caixa
28571	CHARRUA-MGD-REVERSÍVEL	MADER GARDEN TOOLS	1/1

## ABRE REGOS ABREZANJAS DITCHER

**AJUSTÁVEL**  
AJUSTABLE  
ADJUSTABLE

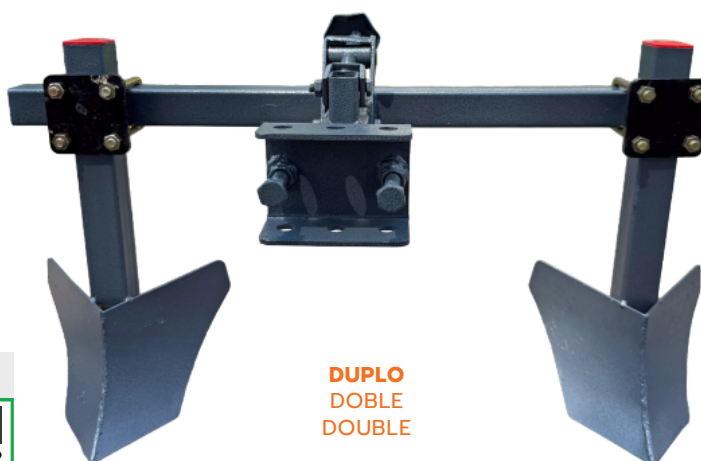
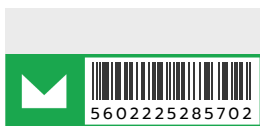

**DUPLO**  
DOBLE  
DOUBLE

**PARA MINI TRATOR**  
PARA MINI TRACTOR  
FOR MINI TRACTOR

**Ref. 28520/28521**

N. Ref.	Descrição	Marca	Quant. Caixa
28570	ABRE REGOS-MGD-DUPLO-AJUSTÁVEL	MADER GARDEN TOOLS	1/1

## FRESAS COMPLETAS CORTADOR COMPLETO ROTARY CUTTER COMPLETE

28569



900 mm

**PARA MINI TRATOR**  
PARA MINI TRACTOR  
FOR MINI TRACTOR

**Ref. 28520/28521**

N. Ref.	Descrição	Marca	Quant. Caixa
28569	FRESAS COMPLETAS-MGD-90CM	MADER GARDEN TOOLS	1/1

## SEMEADORA SEBRADORA SOWER



28573



5602225285733

PARA MINI TRATOR  
PARA MINI TRATOR  
FOR MINI TRACTOR

Ref. 28520/28521

N. Ref.	Descrição	Marca	Quant. Caixa
28573	SEMEADORA-MGD	MADER GARDEN TOOLS	1/1

## PULVERIZADOR PULVERIZADOR SPRAYER

PARA MINI TRATOR  
PARA MINI TRATOR  
FOR MINI TRACTOR

Ref. 28520/28521

2 BRAÇOS  
2 BRAZOS  
2 ARMS

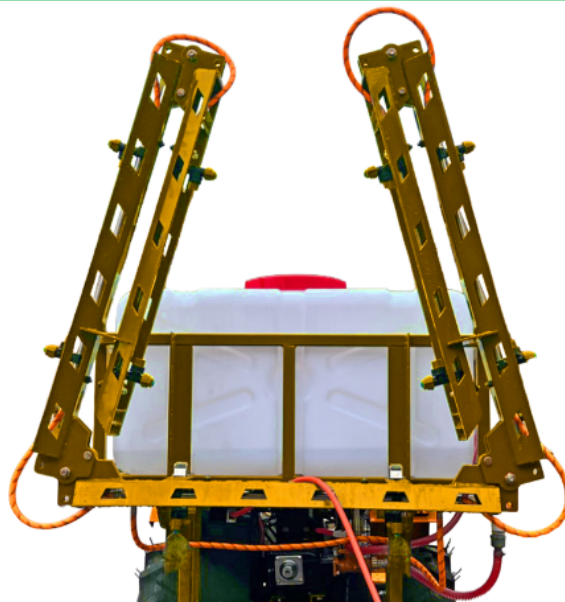

28577



5602225285771

200 L

N. Ref.	Descrição	Marca	Quant. Caixa
28577	ATOMIZADOR-MGD-200L 2 BRAÇOS	MADER GARDEN TOOLS	1/1

## REBOQUE REMOLOQUE TRAILER

500 Kg  
1250 x 800 x 300 mm



28574



5602225285740

PARA MINI TRATOR  
PARA MINI TRATOR  
FOR MINI TRACTOR

Ref. 28520/28521

N. Ref.	Descrição	Marca	Quant. Caixa
28574	REBOQUE-MGD-125X80X30CM 500KG	MADER GARDEN TOOLS	1/1

**MINI TRATOR**  
MINI TRACTOR  
MINI TRACTOR

**DIESEL**



**COM ARCO DE PROTEÇÃO**  
CON ARCO PROTECTOR  
WITH PROTECTION ARCH

**ARRANQUE ELÉTRICO**  
ARRANQUE ELÉCTRICO  
ELECTRIC START

**(2x) Farol frontal de trabalho**  
(2x) Luz de trabajo frontal  
(2x) Front work light

**TOMADA FORÇA - PTO**  
TOMADA FUERZA - PTO  
POWER TAKE OFF - PTO

**2 VELOCIDADES**  
2 GEARS



**456 cc**



**Fresas - 4x (500 x 120 mm)**  
**Cavalete para Fresas**  
Cortadorres - 4x (500 x 120 mm)  
Soporte de Fresado  
Cutters - 4x (500 x 120 mm)  
Milling Stand

<b>Motor / Engine</b>	<b>Diesel</b>
<b>Potência / Potencia / Power</b>	<b>7.2 kW</b>
<b>RPM</b>	<b>3600</b>
<b>Velocidades / Marchas / Gears</b>	<b>2 - (R + 1)</b>
<b>Roda / Rueda / Wheel</b>	<b>(4x) 6.0 - 12</b>
<b>Ruído / Noise</b>	<b>109 dB(A)</b>
<b>Fresagem (Profundidade) / Fresado (Profundidad)</b>	<b>&gt; 120 mm</b>
<b>Fresagem (Largura) / Fresado (Ancho) / Tilling (Width)</b>	<b>1050 mm</b>

N. Ref.	Descrição	Marca	Quant. Caixa
28522	MINI TRATOR-MGD-456CC DIESEL	MADER GARDEN TOOLS	1/1

PARA MINI TRATOR  
PARA MINI TRACTOR  
FOR MINI TRACTOR

Ref. 28522

### ABRE REGOS ABREZANJAS DITCHER

**AJUSTÁVEL**  
AJUSTABLE  
ADJUSTABLE



? m



N. Ref.	Descrição	Marca	Quant. Caixa
28581	ABRE REGOS AJUST-MGD-P/28522	MADER GARDEN TOOLS	1/1

### CHARRUA VERTEDERA PLOUGH

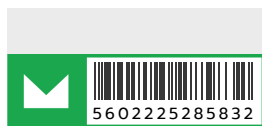

? m



N. Ref.	Descrição	Marca	Quant. Caixa
28583	CHARRUA-MGD-P/28522	MADER GARDEN TOOLS	1/1

### CHARRUA VERTEDERA PLOUGH

**REVERSÍVEL**  
REVERSIBLE



? m



N. Ref.	Descrição	Marca	Quant. Caixa
28582	CHARRUA REVERSÍVEL-MGD-P/28522	MADER GARDEN TOOLS	1/1

### REBOQUE REMOLOQUE TRAILER



? m



N. Ref.	Descrição	Marca	Quant. Caixa
28580	REBOQUE-MGD-P/28522	MADER GARDEN TOOLS	1/1

**MÁQUINA DE CORTE DE ERVA**  
**MOTOSEGADORA**  
**SCYTHE MOWER**

**2 Velocidades**  
**2 Speeds**



**Roda Pneumática**  
**Rueda Neumática**  
**Air Wheel**

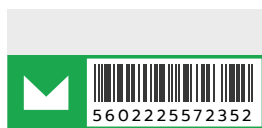

**212cc**  
**900mm**

**4T - Gasolina 95**  
**4S - Gasoline 95**

<b>Potência / Potencia / Power</b>	<b>4.1kW</b>
<b>RPM</b>	<b>3600</b>
<b>Filtro Ar / Filtro de aire / Air Filter</b>	<b>Óleo</b>
<b>Depósito Combustível / Depósito Combustible / Fuel Tank</b>	<b>3.6L</b>
<b>Arranque / Start System</b>	<b>Manual</b>
<b>Velocidade / Velocidad / Speed</b>	<b>2 (R + 1)</b>
<b>Caixa Transmissão / Caja Transmisión / Gear Box</b>	<b>Valvulina (80W90)</b>
<b>Cárter / Crankcase</b>	<b>0.6L (10W40 /15W40 /SAE30)</b>
<b>Corte (Altura) / Cut (Height)</b>	<b>10 » 80mm</b>
<b>Roda / Rueda / Wheel</b>	<b>3,30 x 6" (x 2)</b>
<b>Ruído / Noise</b>	<b>109 dB</b>

**Transmissão » Correia**  
**Transmisión » Correa**  
**Transmission » Belt**

**Valvulina ( incluído)**  
**Valvulina (incluido)**  
**Valvuline ( included)**

**80W90 - Recom. ref. 25200**

**Óleo (não incluído)**  
**Aceite (no incluido)**  
**Oil (not included)**

**10W40 - Recom. ref. 25203**



N. Ref.	Descrição	Marca	Quant. Caixa
57235	MAQ CORTE ERVA-MGD-7,0HP 4.1KW	MADER GARDEN TOOLS	1

## LÂMINA CUCHILLA BLADE ASSY

MÁQUINA CORTE ERVA  
MOTOGUADAÑA  
SCYTHE MOWER

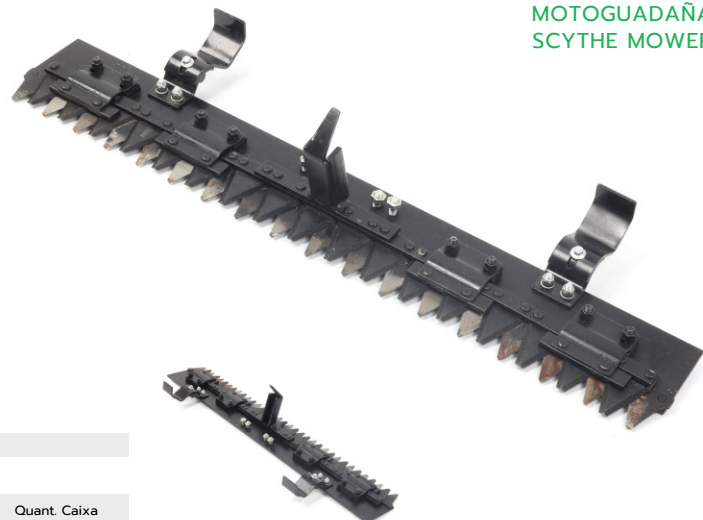

900 mm

Para Modelo / Para El Modelo / For Model **57235**

N. Ref.	Descrição	Marca	Quant. Caixa
57233	CONJ PENTES P/MAQ CORTE ERVA	MADER GARDEN TOOLS	1/1

## PENTE COMPLETO PEINE COMPLETO CONNECTOR + BLADE

MÁQUINA CORTE ERVA  
MOTOGUADAÑA  
SCYTHE MOWER



Para Modelo / Para El Modelo / For Model **57235**

N. Ref.	Descrição	Marca	Quant. Caixa
57232	PENTE COMPLETO P/MQ.CORTE ERVA	MADER GARDEN TOOLS	1/1

## RODAS PNEUMÁTICAS RUEDAS NEUMÁTICAS PNEUMATIC WHEELS

MÁQUINA CORTE ERVA  
MOTOGUADAÑA  
SCYTHE MOWER



1 par (2un)

Para Modelo / Para El Modelo / For Model **57235**

N. Ref.	Descrição	Marca	Quant. Caixa
57231	RODAS PNEUM P/MAQ C/ERVA PAR	MADER GARDEN TOOLS	1/1

**DESTROÇADOR DE MATO**  
**SEGADORA DE MARTILLOS**  
**FLAIR MOWER**



**196 cc**  
**600 mm**

<b>Refrigerado a Ar / Refrigerado al Aire / Air Cooled</b>	<b>Sim</b>
<b>RPM</b>	<b>3600</b>
<b>Arranque / Start System</b>	<b>Manual</b>
<b>Depósito Combustível / Depósito Combustible / Fuel Tank</b>	<b>3.6 L</b>
<b>Ruído / Noise</b>	<b>105 dB (A)</b>
<b>Velocidades / Marchas / Gears</b>	<b>2F + 1R</b>

N. Ref.	Descrição	Marca	Quant. Caixa
28509	DESTROÇADOR MATO-MGD-212CC	MADER GARDEN TOOLS	1/1



**4T - Gasolina 95**  
**4T - Gasoline 95**

# MADER®

# GARDEN TOOLS



**MÁQUINA DE CORTAR MATO**  
MÁQUINA DE DESBROCE  
MOWER

**Arranque Elétrico**  
Arranque Electrico  
Electric Start

**PODE SER RODADO 360° SOBRE SI MESMO**  
SE PUEDE GIRAR 360° SOBRE SÍ MISMO  
CAN BE ROTATED 360° IN PLACE

**CONTROLO REMOTO**  
CONTROL REMOTO  
REMOTE-CONTROL

**Locomoção por lagartas**  
Marcha por orugas  
Crawler walking



**340cc**

670mm

57236



5602225572369

**608cc**

900mm

57237



5602225572376

<b>RPM</b>	<b>3300</b>
<b>Bateria / Bateria / battery</b>	<b>12V - 20Ah (2*)</b>
<b>Área (máx.) / Area (máx.)</b>	<b>0 ~ 200 m</b>
<b>Corte (Altura) / Cut (Height)</b>	<b>20 - 140mm</b>
<b>Velocidade / Velocidad / Speed</b>	<b>0 ~ 5 km/h</b>

**Não corte declives muito íngremes inferior a 30°**

**No corte pendientes demasiado pronunciadas - inferior a 30°**

**Do not trim too steep slopes below 30°**

N. Ref.	Descrição	Marca	Quant. Caixa
57236	MAQ CORTA MATO-MGD-C/COM 340CC	MADER GARDEN TOOLS	1/1
57237	MAQ CORTA MATO-MGD-C/COM 608CC	MADER GARDEN TOOLS	1/1

**4T - Gasolina 95**  
4S - Gasoline 95

**MADER**

**TRABALHA COMO UM PROFISSIONAL**

26JAN21 20

## ESCARIFICADOR ESCARIFICADOR MINI TILLER



**25.4cc**  
400mm

Potência / Potencia / Power	<b>11hp</b>
Depósito Combustível / Depósito Combustible / Fuel Tank	<b>1L</b>
Fresagem (Profundidade) / Fresado (Profundidad)	<b>130 ~ 260mm</b>

N. Ref.	Descrição	Marca	Quant. Caixa
28385	ESCARIFICADOR-MGD-25.4CC	MADER GARDEN TOOLS	1/1



**2T - Gasolina Mix 4%**

**Mix 4% - Ref. 25208 - 1L (n. incl.)**

## ESCARIFICADOR ESCARIFICADOR MINI TILLER



**2T - Gasolina Mix 4%**

**Mix 4% - Ref. 25208 - 1L (n. incl.)**



**52cc**  
250 - 300mm

Potência / Potencia / Power	<b>19hp</b>
Depósito Combustível / Depósito Combustible / Fuel Tank	<b>12L</b>
Fresagem (Profundidade) / Fresado (Profundidad)	<b>100 ~ 150mm</b>

N. Ref.	Descrição	Marca	Quant. Caixa
28440	ESCARIFICADOR-MGD-52CC	MADER POWER TOOLS	1/1



**MOTOENXADA**  
**MOTOAZADA**  
**MOTOR HOE**



**GUIADOR - ALTURA AJUSTÁVEL**  
**MANILLAR - ALTURA AJUSTABLE**  
**HANDLEBAR - HEIGHT ADJUSTABLE**

**Correias**  
 Correas  
 Belt Run

**FRESAGEM - 950MM**  
**FRESADO - 950MM**  
**TILLING - 950MM**

- 1 - Abre Regos - Fixo
- 1 - Fresas - 2x (500xØ350mm)
- 2 - Roda Pneumática
- 1 - Roda Borracha

- 1 - Abrezanjas - Fijo
- 1 - Cortadores - 2x (500xØ350mm)
- 2 - Rueda Neumática
- 1 - Rueda Goma

- 1 - Digger - Fixed
- 1 - Cutters - 2x (500xØ350mm)
- 2 - Air Wheel
- 1 - Rubber Wheel



**212 cc**

<b>RPM</b>	<b>3600</b>
<b>Filtro Ar / Filtro de aire / Air Filter</b>	<b>Óleo</b>
<b>Refrigerado a Ar / Refrigerado al Aire / Air Cooled</b>	<b>Sim</b>
<b>Arranque / Start System</b>	<b>Manual</b>
<b>Velocidades / Marchas / Gears</b>	<b>3 - ( R + 1 + 2 )</b>
<b>Sistema Segurança / Sistema de seguridad</b>	<b>Paragem Automática</b>
<b>Caixa Transmissão / Caja Transmisión / Gear Box</b>	<b>15L - Valvulina (80W90)</b>
<b>Cárter / Crankcase</b>	<b>0.65L (10W40 /15W40 /SAE30)</b>
<b>Fresagem (Largura) / Fresado (Ancho) / Tilling (Width)</b>	<b>950mm</b>
<b>Fresagem (Profundidade) / Fresado (Profundidad)</b>	<b>&gt; 150mm</b>
<b>Roda Pneumática / Rueda Neumática / Pneumatic Wheel</b>	<b>4.00 x 8"</b>
<b>Depósito Combustível / Depósito Combustible / Fuel Tank</b>	<b>3.6L</b>
<b>Ruído / Noise</b>	<b>86 dB(A)</b>

**4T - Gasolina 95**  
 4S - Gasoline 95

**Valvulina (não incluído)**  
 Valvulina (no incluido)  
 Valvuline (not included)

**80W90 - Ref. 25200 - 1L**

**Óleo (não incluído)**  
 Aceite (no incluido)  
 Oil (not included)

**10W40 - Ref. 25203 - 1L**

N. Ref.	Descrição	Marca	Quant. Caixa
28435	MOTOENXADA-MGD-212CC 3V	MADER GARDEN TOOLS	1/1

**MOTOENXADA**  
MOTOAZADA  
MOTOR HOE

**3 Velocidades**  
3 Gears



**Guiador - Altura Ajustável**  
**(2 Posições)**

Manillar - Altura Ajustable

(2 Posiciones)

Handlebar - Height Adjustable

(2 Positions)



28405



5602225284057

**196cc**

**Fixo**



**2x (500xØ350mm)**

**4T - Gasolina 95**

4S - Gasoline 95

<b>RPM</b>	<b>3600</b>
<b>Filtro Ar / Filtro de aire / Air Filter</b>	<b>Óleo</b>
<b>Arranque / Start System</b>	<b>Manual</b>
<b>Velocidades / Marchas / Gears</b>	<b>3 - (R + 1 + 2)</b>
<b>Caixa Transmissão / Caja Transmisión / Gear Box</b>	<b>(80W90) Valvulina - 15L</b>
<b>Cárter / Crankcase</b>	<b>0.65L (10W40 /15W40 /SAE30)</b>
<b>Fresagem (Largura) / Fresado (Ancho) / Tilling (Width)</b>	<b>500 - 900mm</b>
<b>Fresagem (Profundidade) / Fresado (Profundidad)</b>	<b>100 - 350mm</b>
<b>Roda Pneumática / Rueda Neumática / Pneumatic Wheel</b>	<b>4.00 x 8"</b>
<b>Depósito Combustível / Depósito Combustible / Fuel Tank</b>	<b>3.6L</b>
<b>Ruído / Noise</b>	<b>86 dB(A)</b>

**Transmissão » Engrenagem**

Transmisión » Engranaje

Transmission » Gear

**Valvulina (não incluído)**

Valvulina (no incluido)

Valvuline (not included)

**80W90 - Recom. ref. 25200 - 1L**

**Óleo (não incluído)**

Aceite (no incluido)

Oil (not included)

**10W40 - Recom. ref. 25203 - 1L**



N. Ref.	Descrição	Marca	Quant. Caixa
28405	MOTOENXADA-MGD-7HP 3VEL	MADER GARDEN TOOLS	1

**MOTOENXADA**  
MOTOAZADA  
MOTOR HOE

**3**  
Velocidades | Gears

**COM FILTRO AR » ELEVADO**  
CON FILTRO AIRE » ALTO  
WITH AIR FILTER » HIGH

**GUIADOR - ALTURA AJUSTÁVEL**  
(2 POSIÇÕES)  
MANILLAR - ALTURA AJUSTABLE  
(2 POSICIONES)  
HANDLEBAR - HEIGHT ADJUSTABLE  
(2 POSITIONS)

**FRESAGEM - 900MM**  
FRESADO - 900MM  
TILLING - 900MM

1 - Abre Regos - Fixo  
1 - Fresas - 2x (500xØ350mm)  
2 - Roda Pneumática  
1 - Roda Borracha

1 - Abrezanjas - Fijo  
1 - Cortadores - 2x (500xØ350mm)  
2 - Rueda Neumática  
1 - Rueda Goma

1 - Digger - Fixed  
1 - Cutters - 2x (500xØ350mm)  
2 - Air Wheel  
1 - Rubber Wheel

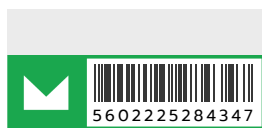

**196 cc**

4T - Gasolina 95  
4S - Gasoline 95

**Engrenagem**  
Engranaje  
Gear

**Valvulina (não incluído)**  
Valvulina (no incluido)  
Valvuline (not included)

**80W90 - Ref. 25200 - 1L**

**Óleo (não incluído)**  
Aceite (no incluido)  
Oil (not included)

**10W40 - Ref. 25203 - 1L**

<b>RPM</b>	<b>3600</b>
<b>Filtro Ar</b> / Filtro de aire / Air Filter	<b>Óleo</b>
<b>Arranque</b> / Start System	<b>Manual</b>
<b>Velocidades</b> / Marchas / Gears	<b>3 - (R + 1 + 2)</b>
<b>Caixa Transmissão</b> / Caja Transmisión / Gear Box	<b>1.5L - Valvulina (80W90)</b>
<b>Cárter</b> / Crankcase	<b>0.65L (10W40 /15W40 /SAE30)</b>
<b>Fresagem (Largura)</b> / Fresado (Ancho) / Tilling (Width)	<b>500 - 900mm</b>
<b>Fresagem (Profundidade)</b> / Fresado (Profundidad)	<b>100 - 350mm</b>
<b>Roda Pneumática</b> / Rueda Neumática / Pneumatic Wheel	<b>4.00 x 8"</b>
<b>Depósito Combustível</b> / Depósito Combustible / Fuel Tank	<b>3.6L</b>
<b>Ruído</b> / Noise	<b>86 dB(A)</b>



N. Ref.	Descrição	Marca	Quant. Caixa
28434	MOTOENXADA-MGD-196CC 3V FIL AR	MADER GARDEN TOOLS	1/1

**MOTOENXADA**  
MOTOAZADA  
MOTOR HOE

**3 Velocidades**  
**3 Gears**



**Guiador - Altura Ajustável**  
Manillar - Altura Ajustable  
Handlebar - Height Adjustable

**Fixo**



**900 mm**



28426



5602225284262

**208 cc**

**4T - Gasolina 95**  
**4S - Gasoline 95**

<b>RPM</b>	<b>3600</b>
<b>Filtro Ar / Filtro de aire / Air Filter</b>	<b>Óleo</b>
<b>Arranque / Start System</b>	<b>Manual</b>
<b>Velocidades / Cambio / Gears</b>	<b>3 - (R + 1 + 2)</b>
<b>Caixa Transmissão / Caja Transmisión / Gear Box</b>	<b>15L - Valvulina (80W90)</b>
<b>Cárter / Crankcase</b>	<b>0.7L (10W40 /15W40 /SAE30)</b>
<b>Fresagem (Largura) / Fresado (Ancho) / Tilling (Width)</b>	<b>500 - 900mm</b>
<b>Fresagem (Profundidade) / Fresado (Profundidad)</b>	<b>100 - 350mm</b>
<b>Roda Pneumática / Rueda Neumática / Pneumatic Wheel</b>	<b>4.00 x 8"</b>
<b>Depósito Combustível / Depósito Combustible / Fuel Tank</b>	<b>3.6L</b>
<b>Ruído / Noise</b>	<b>86 dB(A)</b>

**Transmissão » Engrenagem**  
Transmisión » Engranaje  
Transmission » Gear

**Valvulina (não incluído)**  
Valvulina (no incluido)  
Valvuline (not included)

**80W90 - Recom. ref. 25200 - 1L**

**Óleo (não incluído)**  
Aceite (no incluido)  
Oil (not included)

**10W40 - Recom. ref. 25203 - 1L**



N. Ref.	Descrição	Marca	Quant. Caixa
28426	MOTOENXADA-MGD-208CC 3 VELOCID	MADER GARDEN TOOLS	1

**MOTOENXADA**  
MOTOAZADA  
MOTOR HOE

**3 Velocidades**  
3 Gears

**COM FILTRO AR » ELEVADO**  
CON FILTRO AIRE » ALTO  
WITH AIR FILTER » HIGH

**GUIADOR - ALTURA AJUSTÁVEL**  
MANILLAR - ALTURA AJUSTABLE  
HANDLEBAR - HEIGHT  
ADJUSTABLE

**FRESAGEM - 900MM**  
FRESADO - 900MM  
TILLING - 900MM

**Abre Regos - Fixo**  
**Fresas - 2x (500xØ350mm)**  
**Roda Pneumática**  
**Roda Borracha**

Abrezanjas - Fijo  
Cortadores - 2x (500xØ350mm)  
Rueda Neumática  
Rueda Goma

Digger - Fixed  
Cutters - 2x (500xØ350mm)  
Air Wheel  
Rubber Wheel



**208 cc**

<b>RPM</b>	<b>3600</b>
<b>Filtro Ar / Filtro de aire / Air Filter</b>	<b>Óleo</b>
<b>Arranque / Start System</b>	<b>Manual</b>
<b>Velocidades / Marchas / Gears</b>	<b>3 - ( R + 1 + 2 )</b>
<b>Sistema Segurança / Sistema de seguridad</b>	<b>Paragem Automática</b>
<b>Caixa Transmissão / Caja Transmisión / Gear Box</b>	<b>15L - Valvulina (80W90)</b>
<b>Cárter / Crankcase</b>	<b>0.7L (10W40 /15W40 /SAE30)</b>
<b>Fresagem (Largura) / Fresado (Ancho) / Tilling (Width)</b>	<b>500 - 900mm</b>
<b>Fresagem (Profundidade) / Fresado (Profundidad)</b>	<b>100 - 350mm</b>
<b>Roda Pneumática / Rueda Neumática / Pneumatic Wheel</b>	<b>4.00 x 8"</b>
<b>Depósito Combustível / Depósito Combustible / Fuel Tank</b>	<b>3.6L</b>
<b>Ruído / Noise</b>	<b>86 dB(A)</b>

**4T - Gasolina 95**  
4S - Gasoline 95

**Engrenagem**  
Engranaje  
Gear

**Valvulina (não incluído)**  
Valvulina (no incluido)  
Valvuline (not included)

**80W90 - Ref. 25200 - 1L**

**Óleo (não incluído)**  
Aceite (no incluido)  
Oil (not included)

**10W40 - Ref. 25203 - 1L**



N. Ref.	Descrição	Marca	Quant. Caixa
28432	MOTOENXADA-MGD-208CC 3V FIL AR	MADER GARDEN TOOLS	1/1

**MOTOENXADA**  
MOTOAZADA  
MOTOR HOE

**ARRANQUE ELÉTRICO**  
ARRANQUE ELÉCTRICO  
ELECTRIC START

**COM FILTRO AR » ELEVADO**  
CON FILTRO AIRE » ALTO  
WITH AIR FILTER » HIGH

**3 Velocidades**  
3 Gears

**GUIADOR - ALTURA AJUSTÁVEL**  
MANILLAR - ALTURA AJUSTABLE  
HANDLEBAR - HEIGHT ADJUSTABLE

**FRESAGEM - 900MM**  
FRESADO - 900MM  
TILLING - 900MM

**Abre Regos - Fixo**  
**Fresas - 2x (500xØ350mm)**  
**Roda Pneumática**  
**Roda Borracha**

Abrezanjas - Fijo  
Cortadores - 2x (500xØ350mm)  
Rueda Neumática  
Rueda Goma

Digger - Fixed  
Cutters - 2x (500xØ350mm)  
Air Wheel  
Rubber Wheel

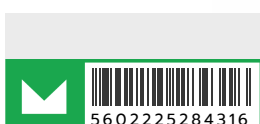

**208 cc**

**4T - Gasolina 95**  
4S - Gasoline 95

<b>RPM</b>	<b>3600</b>
<b>Filtro Ar</b> / Filtro de aire / Air Filter	<b>Óleo</b>
<b>Arranque</b> / Start System	<b>Manual e Eléctrico a Bateria</b>
<b>Bateria</b> / Bateria / battery	<b>18 A</b>
<b>Velocidades</b> / Marchas / Gears	<b>3 - (R + 1 + 2)</b>
<b>Caixa Transmissão</b> / Caja Transmisión / Gear Box	<b>15L - Valvulina (80W90)</b>
<b>Cárter</b> / Crankcase	<b>0.7L (10W40 /15W40 /SAE30)</b>
<b>Fresagem (Largura)</b> / Fresado (Ancho) / Tilling (Width)	<b>500 - 900mm</b>
<b>Fresagem (Profundidade)</b> / Fresado (Profundidad)	<b>100 - 350mm</b>
<b>Roda Pneumática</b> / Rueda Neumática / Pneumatic Wheel	<b>4.00 x 8"</b>
<b>Depósito Combustível</b> / Depósito Combustible / Fuel Tank	<b>3.6L</b>
<b>Ruído</b> / Noise	<b>86 dB(A)</b>

**Engrenagem**  
Engranaje  
Gear

**Valvulina (não incluído)**  
Valvulina (no incluido)  
Valvuline (not included)

**80W90 - Ref. 25200 - 1L**

**Óleo (não incluído)**  
Aceite (no incluido)  
Oil (not included)

**10W40 - Ref. 25203 - 1L**



N. Ref.	Descrição	Marca	Quant. Caixa
28433	MOTOENXAD-MGD-208CC A.EL FIL A	MADER GARDEN TOOLS	1/1
28431	MOTOENXADA-MGD-208CC A.ELE FIL	MADER GARDEN TOOLS	1/1

**MOTOENXADA**  
MOTOZADA  
MOTOR HOE

**ARRANQUE ELÉCTRICO**  
ELECTRIC START

**4 Velocidades**  
4 Gears

**GUIADOR GIRATÓRIO**  
**E ALTURA AJUSTÁVEL**  
MANILLAR GIRATORIO  
Y ALTURA AJUSTABLE  
SWIVEL HANDLEBAR  
AND ADJUSTABLE HEIGHT

**Paragem Automática**  
Parada Automática  
Automatic Stopping

**FRESAGEM - 1050MM**  
FRESADO - 1050MM  
TILLING - 1050MM



**389cc**

<b>Potência / Potencia / Power</b>	<b>10 Hp - 75 Kw</b>
<b>RPM</b>	<b>3600</b>
<b>Filtro Ar / Filtro de aire / Air Filter</b>	<b>Óleo</b>
<b>Arranque / Start System</b>	<b>Arranque Elétrico + Manual</b>
<b>Bateria / Bateria / battery</b>	<b>18A</b>
<b>Velocidades / Marchas / Gears</b>	<b>4 - (R + 1ª (22 rpm) + 2ª + 3ª)</b>
<b>Caixa Transmissão / Caja Transmisión / Gear Box</b>	<b>(80W90) Valvulina - 2.0L</b>
<b>Cárter / Crankcase</b>	<b>13L (10W40 /15W40 /SAE30)</b>
<b>Fresagem (Largura) / Fresado (Ancho) / Tilling (Width)</b>	<b>1050mm</b>
<b>Fresagem (Profundidade) / Fresado (Profundidad)</b>	<b>350mm</b>
<b>Roda Pneumática / Rueda Neumática / Pneumatic Wheel</b>	<b>5.00 x 12"</b>
<b>Depósito Combustível / Depósito Combustible / Fuel Tank</b>	<b>6.5L</b>
<b>Ruído / Noise</b>	<b>96 dB(A)</b>

**4T - Gasolina 95**  
4S - Gasoline 95

**Engrenagem**  
Engranaje  
Gear

**Valvulina (não incluído)**  
Valvulina (no incluido)  
Valvuline (not included)

**80W90 - Ref. 25200 - 1L**

**Óleo (não incluído)**  
Aceite (no incluido)  
Oil (not included)

**10W40 - Ref. 25203 - 1L**



N. Ref.	Descrição	Marca	Quant. Caixa
28430	MOTOENXADA-MGD-389CC ARRQ.ELET	MADER GARDEN TOOLS	1

**MOTOCULTIVADOR**  
MOTOCULTOR  
TILLER



**2 VELOCIDADES**  
2 SPEEDS

**FRESAGEM - 500MM**  
FRESADO - 500MM  
TILLING - 500MM



**4T - Gasolina 95**  
4S - Gasoline 95

**Filtro de papel com pré filtro de esponja**  
Filtro de papel con prefiltro de esponja  
Paper filter with sponge pre-filter

**Engrenagem**  
Engranaje  
Gear

**Valvulina (incluída)**  
Valvulina (incluido)  
Valvuline (included)

**80W90 - Ref. 25200 - 1L**

**Óleo (não incluído)**  
Aceite (no incluido)  
Oil (not included)

**10W40 - Ref. 25203 - 1L**

**SENSOR CONTRA FALTA DE ÓLEO**  
SENSOR DE FALTA DE ACEITE  
OIL SHORTAGE SENSOR



28429



5602225284293

**212cc**  
**500mm**

<b>RPM</b>	<b>3600</b>
<b>Arranque / Start System</b>	<b>Manual</b>
<b>Velocidades / Marchas / Gears</b>	<b>2 - (R + 1)</b>
<b>Caixa Transmissão / Caja Transmisión / Gear Box</b>	<b>(80W90) Valvulina</b>
<b>Cárter / Crankcase</b>	<b>0.6L (10W40 / 15W40 / SAE30)</b>
<b>Fresagem (Profundidade) / Fresado (Profundidad)</b>	<b>175 - 350mm</b>
<b>Roda Pneumática / Rueda Neumática / Pneumatic Wheel</b>	<b>5.00 x 6"</b>
<b>Depósito Combustível / Depósito Combustible / Fuel Tank</b>	<b>3.6 L</b>
<b>Ruído / Noise</b>	<b>102 dB</b>

N. Ref.	Descrição	Marca	Quant. Caixa
28429	MOTOCULTIVADOR-MGD-212CC	MADER GARDEN TOOLS	1/1

## MOTOCULTIVADOR MOTOCULTOR TILLER

**4 Velocidades**  
4 Speeds

**Guiador Reversível e Altura Ajustável**  
Manillar Reversible y Altura Ajustable  
Reversible handlebar and Height Adjustable

**Paragem Automática**  
Parada Automática  
Automatic Stopping

**Fresagem - 500mm**  
Fresado - 500mm  
Tilling - 500mm

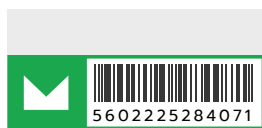

**196cc**

<b>RPM</b>	<b>3600</b>
<b>Filtro Ar / Filtro de aire / Air Filter</b>	<b>Óleo</b>
<b>Arranque / Start System</b>	<b>Manual</b>
<b>Velocidades / Marchas / Gears</b>	<b>4 - (R + R2 + 1 + 2)</b>
<b>Caixa Transmissão / Caja Transmisión / Gear Box</b>	<b>(80W90) Valvulina</b>
<b>Cárter / Crankcase</b>	<b>0.7L (10W40 / 15W40 / SAE30)</b>
<b>Fresagem (Largura) / Fresado (Ancho) / Tilling (Width)</b>	<b>500mm</b>
<b>Fresagem (Profundidade) / Fresado (Profundidad)</b>	<b>80 - 210mm</b>
<b>Roda Pneumática / Rueda Neumática / Pneumatic Wheel</b>	<b>4.00 x 8"</b>
<b>Depósito Combustível / Depósito Combustible / Fuel Tank</b>	<b>3.6L</b>
<b>Ruído / Noise</b>	<b>102 dB</b>

**4T - Gasolina 95**  
4S - Gasoline 95

**Transmissão » Engrenagem**  
Transmisión » Engranaje  
Transmission » Gear

**Valvulina (não incluído)**  
Valvulina (no incluido)  
Valvuline (not included)

**80W90 - Recom. ref. 25200 - 1L**

**Óleo (não incluído)**  
Aceite (no incluido)  
Oil (not included)

**10W40 - Recom. ref. 25203 - 1L**



N. Ref.	Descrição	Marca	Quant. Caixa
28407	MOTOCULTIVADOR-MGD-6,5HP 4V	MADER GARDEN TOOLS	1

**MOTOCULTIVADOR**  
MOTOCULTOR  
TILLER

**DIESEL**

**4 Velocidades**  
4 Speeds

**Guiador Reversível e Altura Ajustável**  
Manillar Reversible y Altura Ajustable  
Reversible handlebar and Height  
Adjustable

**Paragem Automática**  
Parada Automática  
Automatic Stopping

**Fresagem - 500mm**  
Fresado - 500mm  
Tilling - 500mm

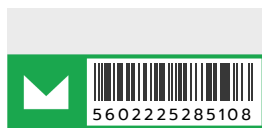

**296cc**

<b>RPM</b>	<b>3600</b>
<b>Filtro Ar / Filtro de aire / Air Filter</b>	<b>Óleo</b>
<b>Refrigerado a Ar / Refrigerado al Aire / Air Cooled</b>	<b>Sim</b>
<b>Arranque / Start System</b>	<b>Manual</b>
<b>Velocidades / Marchas / Gears</b>	<b>4 - (R + R2 + 1 + 2)</b>
<b>Destques / Destacado / Featured</b>	<b>4 Velocidades</b>
<b>Caixa Transmissão / Caja Transmisión / Gear Box</b>	<b>(80W90) Valvulina</b>
<b>Cárter / Crankcase</b>	<b>0.7L (10W40 / 15W40 / SAE30)</b>
<b>Fresagem (Largura) / Fresado (Ancho) / Tilling (Width)</b>	<b>560mm</b>
<b>Fresagem (Profundidade) / Fresado (Profundidad)</b>	<b>200mm</b>
<b>Roda Pneumática / Rueda Neumática / Pneumatic Wheel</b>	<b>4.00 x 8"</b>
<b>Depósito Combustível / Depósito Combustible / Fuel Tank</b>	<b>3.6L</b>
<b>Ruído / Noise</b>	<b>101 dB</b>

**4T - Gasolina 95**  
4S - Gasoline 95

**Transmissão » Engrenagem**  
Transmisión » Engranaje  
Transmission » Gear

**Valvulina (não incluído)**  
Valvulina (no incluido)  
Valvuline (not included)

**80W90 - Recom. ref. 25200 - 1L**

**Óleo (não incluído)**  
Aceite (no incluido)  
Oil (not included)

**10W40 - Recom. ref. 25203 - 1L**

N. Ref.	Descrição	Marca	Quant. Caixa
28510	MOTOCULTIVADOR-MGD-6HP 4V	MADER GARDEN TOOLS	1

**MOTOCULTIVADOR**  
MOTOCULTOR  
TILLER

**GASOLINA**  
**GASOLINE**

**Arranque Eléctrico**  
**Arranque Eléctrico**  
**Electric Start**



**5 VELOCIDADES**  
**5 SPEEDS**

**GUIADOR REVERSÍVEL E**  
**ALTURA AJUSTÁVEL**

**MANILLAR REVERSIBLE Y**  
**ALTURA AJUSTABLE**  
**REVERSIBLE HANDLEBAR AND**  
**HEIGHT ADJUSTABLE**

**Marcha Atrás » desativa as Fresas**  
**( Fresas Soltas » não rodam)**  
Marcha atrás » desactiva las fresas\*  
(las fresas sueltas » no giran)\*  
Reverse Gear » disables the Cutters\*  
( Free Cutters » do not rotate)



**420cc**

<b>RPM</b>	<b>3600</b>
<b>Filtro Ar / Filtro de aire / Air Filter</b>	<b>Óleo</b>
<b>Refrigerado a Ar / Refrigerado al Aire / Air Cooled</b>	<b>Sim</b>
<b>Arranque / Start System</b>	<b>Eléctrico + Manual</b>
<b>Velocidades / Marchas / Gears</b>	<b>5 - ( R + R2 + 1 + 2 + 3)</b>
<b>Caixa Transmissão / Caja Transmisión / Gear Box</b>	<b>(80W90) Valvulina</b>
<b>Cárter / Crankcase</b>	<b>12L (10W40 /15W40 /SAE30)</b>
<b>Fresagem (Largura) / Fresado (Ancho) / Tilling (Width)</b>	<b>660 mm</b>
<b>Fresagem (Profundidade) / Fresado (Profundidad)</b>	<b>80 - 180 mm</b>
<b>Roda Pneumática / Rueda Neumática / Pneumatic Wheel</b>	<b>5.00 x 10"</b>
<b>Depósito Combustível / Depósito Combustible / Fuel Tank</b>	<b>6.5 L</b>
<b>Ruído / Noise</b>	<b>105 dB(A)</b>



**4T - Gasolina 95**  
**4S - Gasoline 95**

**Engrenagem**  
**Engranaje**  
**Gear**

**Valvulina (incluída)**  
**Valvulina (incluido)**  
**Valvuline (included)**

**80W90 - Ref. 25200 - 1L**

**Óleo (não incluído)**  
**Aceite (no incluido)**  
**Oil (not included)**

**10W40 - Ref. 25203 - 1L**



N. Ref.	Descrição	Marca	Quant. Caixa
28511	MOTOCULTIVADOR-MGD-15HP 420CC	MADER GARDEN TOOLS	1/1

**MOTOCULTIVADOR**  
MOTOCULTOR  
TILLER

**DIESEL**

**Arranque Eléctrico**  
Arranque Eléctrico  
Electric Start



**5 VELOCIDADES**  
5 SPEEDS

**GUIADOR REVERSÍVEL E**  
**ALTURA AJUSTÁVEL**

MANILLAR REVERSIBLE Y  
ALTURA AJUSTABLE  
REVERSIBLE HANDLEBAR AND  
HEIGHT ADJUSTABLE

**Marcha Atrás » desativa as Fresas**  
**( Fresas Soltas » não rodam)**  
Marcha atrás » desactiva las fresas  
(las fresas sueltas » no giran)  
Reverse Gear » disables the Cutters  
( Free Cutters » do not rotate)



**418cc**

<b>RPM</b>	<b>3600</b>
<b>Filtro Ar / Filtro de aire / Air Filter</b>	<b>Óleo</b>
<b>Refrigerado a Ar / Refrigerado al Aire / Air Cooled</b>	<b>Sim</b>
<b>Arranque / Start System</b>	<b>Eléctrico + Manual</b>
<b>Velocidades / Marchas / Gears</b>	<b>5 - (R + R2 + 1 + 2 + 3)</b>
<b>Caixa Transmissão / Caja Transmisión / Gear Box</b>	<b>(80W90) Valvulina</b>
<b>Cárter / Crankcase</b>	<b>12L (10W40 /15W40 /SAE30)</b>
<b>Fresagem (Largura) / Fresado (Ancho) / Tilling (Width)</b>	<b>660 mm</b>
<b>Fresagem (Profundidade) / Fresado (Profundidad)</b>	<b>80 - 180 mm</b>
<b>Roda Pneumática / Rueda Neumática / Pneumatic Wheel</b>	<b>5.00 x 10"</b>
<b>Depósito Combustível / Depósito Combustible / Fuel Tank</b>	<b>6.5 L</b>
<b>Ruído / Noise</b>	<b>105 dB(A)</b>

N. Ref.	Descrição	Marca	Quant. Caixa
28512	MOTOCULTIVAD-MGD-9HP 418CC DIE	MADER GARDEN TOOLS	1/1



**4T - Diesel**  
**4S - Diesel**

**Engrenagem**  
Engranaje  
Gear

**Valvulina (incluída)**  
Valvulina (incluido)  
Valvuline (included)

**80W90 - Ref. 25200 - 1L**

**Óleo (não incluído)**  
Aceite (no incluido)  
Oil (not included)

**10W40 - Ref. 25203 - 1L**

## DESTROÇADOR / CORTADOR DE MATO DESBROZADORA / TRITURADORA BUSH CUTTER / MOWER



**600 mm**

Ref. 28402



Encaixe / Encaje / Fitting	Ø 52 mm
	100 mm
	2 Dentes
Medidas / Measures	77 x 79 x 53 cm

N. Ref.	Descrição	Marca	Quant. Caixa
28559	DESTROÇ/CORT MATO 60CM 2D	MADER	1/1

## ENGATE RÁPIDO ACOPLAMIENTO RÁPIDO QUICK HITCH

**2 Dentes**

2 Dientes

2 Teeth

Ref. 28402



Ref. 28511, 28512



**só Macho**  
**solo Macho**  
**Male only**

Encaixe / Encaje / Fitting	Ø 52 mm
	100 mm

N. Ref.	Descrição	Marca	Quant. Caixa
28560	ENGATE RÁPIDO 2D	MADER	1/1
28579	ENG RÁP MACHO-MGD-LIG 2DENTES	MADER GARDEN TOOLS	1/1



## PNEU NEUMÁTICO TIRE

**5.00 x 10"**

6PR



## CÂMARA DE AR CÂMARA DE AIRE AIR CHAMBER

**5.00~10"**

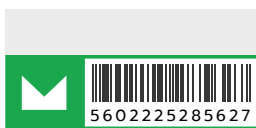

Ref.: 28402  
- 28511  
- 28512

N. Ref.	Descrição	Marca	Quant. Caixa
28561	PNEU-MGD-6PR 5.00-10	MADER GARDEN TOOLS	0/1
28562	CAMARA AR-MGD-5.00-10	MADER GARDEN TOOLS	0/1

## LÂMINA CORTE ERVA CUCHILLA CORTE HIERBA CUT GRASS BLADE

para Motocultivador  
para Motocultor  
for Tiller

Ref. 28402



28412



56 02225 284125

1170 mm

N. Ref.	Descrição	Marca	Quant. Caixa
28412	LÂMINA CORTE ERVA-MGD-P/28402	MADER GARDEN TOOLS	1

## FRESAS COMPLETAS CORTADOR COMPLETO ROTARY CUTTER COMPLETE

para Motocultivador  
para Motocultor  
for Tiller

Ref. 28402



28417



56 02225 284170

80 - 180 mm

Fresagem (Profundidade) / Fresado (Profundidad)

N. Ref.	Descrição	Marca	Quant. Caixa
28417	FRESAS COMPLETAS P/28402	MADER GARDEN TOOLS	1

## FACA CUCHILLO KNIFE

ESQUERDA  
IZQUIERDA  
LEFT

DIREITA  
DERECHA  
RIGHT



56 02225 285528



56 02225 285535



20 x 3 cm

Medidas / Measures

2 un (dist. 5.5 cm)

Furos / Agujeros / Holes

N. Ref.	Descrição	Marca	Quant. Caixa
28552	FACA ESQUERDA P/MOTOCULTIVADOR	MADER GARDEN TOOLS	60
28553	FACA DIREITA P/MOTOCULTIVADOR	MADER GARDEN TOOLS	60

Ref. 28402

## ARRANCADOR DE BATATAS COSECHA DE PATATAS POTATO DIGGER

para Motocultivador  
para Motocultor  
for Tiller

Ref. 28511 - 28512



28296



5602225282961

13 posições  
13 posiciones  
13 positions



com Adaptador  
con Adaptador  
with Adapter

Medidas / Measures	37 x 83 x 68 cm
Encaixe / Encaje / Fitting	<-> 35 mm

N. Ref.	Descrição	Marca	Quant. Caixa
28296	ARRANCADOR BATATAS C/ADAPT	MADER	1

## ABRE-REGOS ABRE ZANJAS RIDGE PLOW

para Motocultivador  
para Motocultor  
for Tiller

Ref. 28511 - 28512



28410



5602225284101

5 Posições  
5 Posiciones  
5 Positions



com Adaptador  
con Adaptador  
with Adapter

Medidas / Measures	40 x 80 x 54 cm
Encaixe / Encaje / Fitting	Ø 42 100mm

N. Ref.	Descrição	Marca	Quant. Caixa
28410	ABRE REGOS C/ADAPTADOR	MADER GARDEN TOOLS	1

## ABRE REGOS ABREZANJAS DITCHER

para Motocultivador  
para Motocultor  
for Tiller

Ref. 28511 - 28512

Regulável  
Regulable  
Adjustable



28398



5602225283982

5 + 15 posições



com Adaptador  
con Adaptador  
with Adapter

Medidas / Measures	52 x 90 x 51 cm
Encaixe / Encaje / Fitting	Ø 42 <-> 100mm

N. Ref.	Descrição	Marca	Quant. Caixa
28398	ABRE REGOS REGULÁVEL	MADER GARDEN TOOLS	1

## CHARRUA REVERSÍVEL VERTEDERA REVERSIBLE REVERSIBLE PLOW

REVERSÍVEL  
REVERSIBLE



15 Posições  
15 Posiciones  
15 Positions

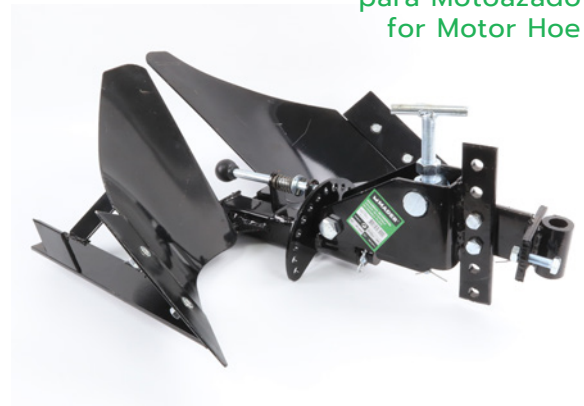

para Motoenxada  
para Motoazado  
for Motor Hoe

com Adaptador  
con Adaptador  
with Adapter

N. Ref.	Descrição	Marca	Quant. Caixa
28420	CHARRUA REVERSÍVEL	MADER	1

## LIMPA NEVE QUITANIEVES SNOW PUSHER



5 Posições  
5 Posiciones  
5 Positions

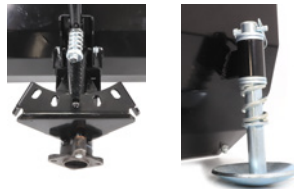

para Motocultivador  
para Motocultor  
for Tiller

Ref. 28511 - 28512

com Adaptador  
con Adaptador  
with Adapter

<b>Medidas / Measures</b>	<b>100 x 45 x 48 cm</b>
<b>Pega / Manija / Handle</b>	<b>144 cm</b>
<b>Encaixe / Encaje / Fitting</b>	<b>Ø 52 mm</b>
	<b>100 x 113 mm</b>

N. Ref.	Descrição	Marca	Quant. Caixa
28423	LIMPA NEVE	MADER	1

## LIMPA NEVE QUITANIEVES SNOW THROWER



104 x 67 x 115 cm  
Ø 48 mm  
100 mm



para Motocultivador  
para Motocultor  
for Tiller

Ref. 28511 - 28512

com Adaptador  
con Adaptador  
with Adapter

<b>Medidas / Measures</b>	<b>104 x 67 x 115 cm</b>
<b>Encaixe / Encaje / Fitting</b>	<b>Ø 48 mm</b>
	<b>100 mm</b>

N. Ref.	Descrição	Marca	Quant. Caixa
28422	LIMPA NEVES C/FRESAS	MADER	1

**FACA DIREITA**  
CUCHILLA DERECHA  
RIGHT KNIFE



PARA 28429



**ESQUERDA**

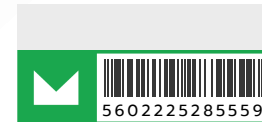

**DIREITA**

N. Ref.	Descrição	Marca	Quant. Caixa
28554	FACA ESQUERDA P/28429	MADER GARDEN TOOLS	0/1
28555	FACA DIREITA P/28429	MADER GARDEN TOOLS	0/1

**RODA COMPLETA**  
RUEDA COMPLETA  
COMPLETE WHEEL

PARA 28429



**PAR**

**PNEU + CÂMARA DE AR**  
NEUMÁTICO + CÁMARA DE AIRE  
TIRE + INNER TUBE



**KIT 2 PCS**

N. Ref.	Descrição	Marca	Quant. Caixa
28557	RODA COMPLETA P/28429-PAR	MADER GARDEN TOOLS	0/1
28558	PNEU+CÂMARA AR P/28429 - KIT 2 PCS	MADER GARDEN TOOLS	0/1

**FRESA PARA MOTOCULTIVADOR**  
CORTADORES DE MOTOCULTOR  
TILLER CUTTERS

PARA 28429



**COMPLETA**  
**COMPLETO**  
**COMPLETE**



N. Ref.	Descrição	Marca	Quant. Caixa
28556	FRESA COMP C/EIXO P/28429-PAR	MADER GARDEN TOOLS	0/1

## CHARRUA ROTATIVA ARADO ROTATIVO ROTARY PLOW

para Motoenxada  
para Motoazado  
for Motor Hoe



28346



5602225283463

**3 Posições**  
3 Posiciones  
3 Positions

sem Adaptador  
sin Adaptador  
without Adapter

N. Ref.	Descrição	Marca	Quant. Caixa
28346	CHARRUA ROTATIVA 3POS S/ADAPT	EUROSYSTEM	1

## ABRE REGOS ABREZANJAS DITCHER

**FIXO**  
FIJO  
FIXED



**REGULÁVEL**  
REGULABLE  
ADJUSTABLE



para | for  
28388-28383-28401

**REGULÁVEL**  
REGULABLE  
ADJUSTABLE



5602225284163



5602225283456



5602225283975

sem Adaptador  
sin Adaptador  
without Adapter

N. Ref.	Descrição	Marca	Quant. Caixa
28416	ABRE REGOS SIMPLES	MADER GARDEN TOOLS	1
28345	ABRE REGOS REGULAV S/ADAPTADOR	MADER	1
28397	ABRE REGOS AJUSTÁVEL	MADER GARDEN TOOLS	1

## ARRANCADOR DE BATATAS COSECHA DE PATATAS POTATOES HARVESTER

sem Adaptador  
sin Adaptador  
without Adapter



5602225282954



5602225283432

N. Ref.	Descrição	Marca	Quant. Caixa
28295	ARRANCADOR BATATAS S/ADAPT	MADER	12
28343	ARRANCADOR BATATAS S/ADAPTADOR	MADER	1

## DISCO LATERAL DISCO LATERAL SIDE DISC

para Motoenxada  
para Motoazado  
for Motor Hoe

Ref. 48412, 28426, 28388, 48410

Ref. 28403, 28404

Ref.  
28396  
28426  
28432  
28433



2 un (Par)

2 un (Par)

2 un (Par)  
240 mm

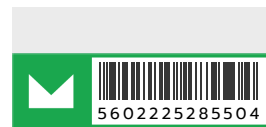

N. Ref.	Descrição	Marca	Quant. Caixa
28549	DISCO LATERAL P/48111	MADER	1
28551	DISCO LATERAL P/48412-28426-28388-48410	MADER	1
28550	DISCO LATERAL P/28403-28404 PAR	MADER	1

## FACA CUCHILLO KNIFE

ESQUERDA  
IZQUIERDA  
LEFT

DIREITA  
DERECHA  
RIGHT



<b>Medidas / Measures</b>	<b>23.5 x 4 cm</b>
<b>Furos / Agujeros / Holes</b>	<b>2 un (dist. 6.5 cm)</b>

N. Ref.	Descrição	Marca	Quant. Caixa
28394	FACA ESQUERDA-MOTOENXADA	MADER GARDEN TOOLS	1
28393	FACA DIREITA-MOTOENXADA	MADER GARDEN TOOLS	1

Ref. 28426, 28388, 48412, 48410

## SUPORTE PARA FRESAS SOPORTE DE FRESAS SUPPORT FOR ROTTARY CUTTER



2 un (Par)  
240 mm

Furo hexagonal  
Agujero hexagonal  
Hexagonal hole



N. Ref.	Descrição	Marca	Quant. Caixa
28396	SUPORTE P/FRESAS PAR	MADER GARDEN TOOLS	1

Ref. 28405, 28383, 48412, 48413

### ADAPTADOR ADAPTADOR ADAPTER

**CHARRUA / ABRE RÊGOS / ARRANCADOR**  
ARADO / ABRAZANJAS / COSECHA  
PLOW / DIGGER / HARVESTER



30 cm - Longo



40 cm - Longo



para Motoenxada  
para Motoazado  
for Motor Hoe

N. Ref.	Descrição	Marca	Quant. Caixa
28360	ADAPT CHARR/AB REG/ARRANC EUR5	MADER GARDEN TOOLS	3/3
28548	ADAPT CHARR/AB LONGO EUR5*40CM	MADER GARDEN TOOLS	1/1

### ADAPTADOR PARA RODA ADAPTADOR PARA RUEDA WHEEL ADAPTER

Ref. 28388  
**RODA FERRO**  
RUEDA HIERRO  
STEEL WHEEL



2 un  
25 mm HEX

N. Ref.	Descrição	Marca	Quant. Caixa
28356	ADAPT P/ROD Fº 2PC 25MM EURO 5	MADER GARDEN TOOLS	1

### RODA PARA MOTOENXADA RUEDA PARA MOTOAZADO MOTOR HOE WHEEL

**Ferro**  
Hierro  
Iron

**UNIVERSAL**

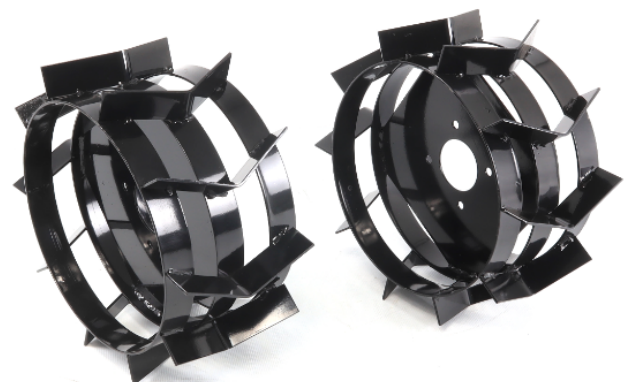

2 un (Par)

Medidas / Measures	Ø 285 mm (Int.)
Medidas / Measures	Ø 340 mm (Ext.)

sem Adaptador  
sin Adaptador  
without Adapter

N. Ref.	Descrição	Marca	Quant. Caixa
28344	RODA FERRO-PAR 2PC-S/ADAPTADOR	EUROSYSTEM	1

## RODA PARA MOTOENXADA RUEDA PARA MOTOAZADO MOTOR HOE WHEEL

**Pneumática**  
Neumática  
Air

com Adaptador  
con Adaptador  
with Adapter



**2 un (Par)**  
23 mm HEX



Medidas / Measures

**4.00 x 8"**

N. Ref.	Descrição	Marca	Quant. Caixa
28390	RODA PN 4.00X8" C/ADAP P/28426	MADER	1

Ref. 28426, 28428, 28405, 48410, 48413

## CÂMARA DE AR CÂMARA DE AIRE AIR CHAMBER



Ref. 87669

**4.00 x 8"**

**Conjunto de 2 peças**  
1 Pneu + 1 Câmara

Juego de 2 piezas  
1 Neumático + 1 Câmara

Set of 2 pieces  
1 Tire + 1 Tube

**4.00 x 8"**



## PNEU + CÂMARA DE AR NEUMÁTICO + CÂMARA DE AIRE TIRE + INNER TUBER



Ref. 48410, 28383, 28388

N. Ref.	Descrição	Marca	Quant. Caixa
28418	CÂMARA AR P/PNEU MOTOEN 4.00-8	MADER	1
87669	PNEU C/CÂMARA AR 2PCS P/48410-28383-28388	MADER	1

## ADAPTADOR ADAPTADOR ADAPTER

para Motoenxada  
para Motoazado  
for Motor Hoe



Ø 15mm

para Ref | for Ref:  
28383, 28388, 28405, 48411, 48412, 48413

N. Ref.	Descrição	Marca	Quant. Caixa
28363	ADAPTADOR P/REBOQUE EURO 5	MADER GARDEN TOOLS	1

**REBOQUE PARA MOTOCULTIVADOR**  
**REMOLOQUE DE ARADO MECÂNICO**  
**MOTOR HOE TRAILER**

**COM BÁSCULA**  
**CON BÁSCULA**  
**WITH WEIGHBRIDGE**

**COM TRAVÃO**  
**CON FRENO**  
**WITH BRAKE**



Medidas / Measures	130 x 90 x 30 cm (Caixa)
Capacidade / Capacidad / Capacity	220 Kg

N. Ref.	Descrição	Marca	Quant. Caixa
28348	REBOQUE P/MOTOCULTIV 120X80	MADER GARDEN TOOLS	1/1

**sem Adaptador**  
**sin Adaptador**  
**without Adapter**

**REBOQUE PARA MOTOCULTIVADOR**  
**REMOLOQUE DE ARADO MECÂNICO**  
**MOTOR HOE TRAILER**

**COM BÁSCULA**  
**CON BÁSCULA**  
**WITH WEIGHBRIDGE**

**COM TRAVÃO**  
**CON FRENO**  
**WITH BRAKE**



Medidas / Measures	111 x 72 x 30 cm (Caixa - Interna)
	35,5 x 18 x 19 cm (assento)
	Total: 120 x 270 x 107 cm
Capacidade / Capacidad / Capacity	500 Kg
Roda / Rueda / Wheel	4.00 x 12"

N. Ref.	Descrição	Marca	Quant. Caixa
28424	REBOQUE P/MOTOCULTIVADOR	MADER	1/1



**com Adaptador**  
**con Adaptador**  
**with Adapter**

**MOTOR GASOLINA**  
MOTOR GASOLINA  
GASOLINE ENGINE

**ARRANQUE MANUAL**  
MANUAL START

**SENSOR NÍVEL ÓLEO**  
SENSOR DE NIVEL DE ACEITE  
OIL LEVEL SENSOR



**Base de Acoplamento Universal**  
Base de Acoplamiento Universal  
Universal Docking Base



**para Motoenxada de Correia**  
para Motoazada de Correa  
for Belt Transmission Hoe

**Guia: 6mm largura**  
**Diâmetro interno: 55mm**  
**Diâmetro externo: 85mm**  
Guia: 6mm ancho  
Diâmetro interior: 55 mm  
Diâmetro exterior: 85 mm  
Guide: 6mm width  
Internal diameter: 55mm  
Outside diameter: 85mm



**para Motoenxada de Engrenagem**  
para Motoazada de Engrenaje for  
Geared Motorshafts

**Veio da Cambota:**  
**Ø 25 x 35 mm (sem Rosca)**  
**Estriado (6 estrias)**  
**Largura do Rasgo: 7mm**  
Eje del Cigüeñal:  
Ø 25 x 35 mm (sin Rosca)  
Estriado (6 estrias)  
Anchura del rasgón: 7mm  
Crankshaft Spindle:  
Ø 25 x 35 mm (Threadless)  
Striated (6 striations)  
Scale tear width: 7mm



**Óleo (não incluído)**  
Aceite (no incluido)  
Oil (not included)

**10W40 - Ref. 25203 - 1L**



**208 cc**

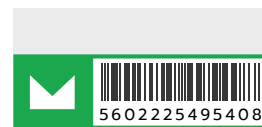

**208 cc**

**Arranque / Start System**

**Manual**

**Manual**

**Potência / Potencia / Power**

**7 hp**

**7 hp**

**Filtro Ar / Filtro de aire / Air Filter**

**Óleo**

**Óleo**

**Cárter / Crankcase**

**0.6L (10W40 / 15W40 / SAE30)**

**0.6L (10W40 / 15W40 / SAE30)**

**Ruído / Noise**

**86 dB(A)**

**86 dB(A)**

N. Ref.	Descrição	Marca	Quant. Caixa
49519	MOTOR GASOL-MGD-7.0 208CC P/CR	MADER GARDEN TOOLS	1
49540	MOTOR GASOL-MGD-7.0 208CC P/EG	MADER GARDEN TOOLS	1

## MOTOR A GASOLINA

MOTOR DE GASOLINA  
GASOLINE ENGINE

## SENSOR NÍVEL ÓLEO

SENSOR DE NIVEL DE ACEITE  
OIL LEVEL SENSOR

## ARRANQUE ELÉTRICO

ARRANQUE ELÉCTRICO  
ELECTRIC START

## Base de Acoplamento Universal

Base de Acoplamiento Universal  
Universal Docking Base

para Motoenzada de Engrenagem  
para Motoazada de Engrenaje  
for Geared Motorshafts

**Veio da Cambota:**  
Ø 25 x 35 mm (sem Rosca)  
Estriado (6 estrías)  
Largura do Rasgo: 7mm

**Eje del Cigüeñal:**  
Ø 25 x 35 mm (sin Rosca)  
Estriado (6 estrías)  
Anchura del rasgón: 7mm

**Crankshaft Spindle:**  
Ø 25 x 35 mm (Threadless)  
Striated (6 striations) Scale  
tear width: 7mm



49541



5602225495415

**389 cc**

Arranque / Start System	Eléctrico
Potência / Potencia / Power	10 hp
Filtro Ar / Filtro de aire / Air Filter	Óleo
Cárter / Crankcase	0.6L (10W40 / 15W40 / SAE30)
Ruido / Noise	96 dB(A)



4 T - Gasolina - EURO V  
4 S - Gasoline - EURO V

Óleo (não incluído)  
Aceite (no incluido)  
Oil (not included)

10W40 - Ref. 25203 - 1L

N. Ref.	Descrição	Marca	Quant. Caixa
49541	MOTOR GASOL-MGD-10HP P/ARR ELE	MADER GARDEN TOOLS	1

## SISTEMA DE ARRANQUE

SISTEMA DE ARRANQUE  
STARTING SYSTEM



28419



5602225284194

Para Modelo / Para El Modelo / For Model **28426**

N. Ref.	Descrição	Marca	Quant. Caixa
28419	SISTEMA DE ARRANQUE P/28426	MADER	1

### ABRE BURACOS TALADRO DE TIERRA GROUND AUGER



Capacidade máxima: Ø200 mm  
Opcional » Medidas disponíveis:  
Ø 80, 100, 150, 200mm (x 700mm)  
Capacidad máxima: Ø200 mm  
Opcional » Tamaños disponibles:  
Ø 80, 100, 150, 200mm (x 700mm)  
Maximum capacity: Ø200 mm  
Optional » Available sizes:  
Ø 80, 100, 150, 200mm (x 700mm)

**3 BROCAS (INCLUÍDAS)**  
**3 DRILL (INCLUDED)**  
Ø 100 x 700mm  
Ø 150 x 700mm  
Ø 200 x 700mm



**51.7 cc**



<b>Potência / Potencia / Power</b>	<b>147 kW</b>
<b>RPM</b>	<b>6500</b>
<b>Depósito Combustível / Depósito Combustible / Fuel Tank</b>	<b>12 L</b>
<b>Caixa Transmissão / Caja Transmisión / Gear Box</b>	<b>34:1</b>
<b>Ruido / Noise</b>	<b>108 db(A)</b>

**2T - Gasolina Mix 4%**  
**2T - Gasoline Mix 4%**

N. Ref.	Descrição	Marca	Quant. Caixa
69523	ABRE BURACOS-MGD-51.7CC 3BROCA	MADER GARDEN TOOLS	1/1

**Mix 4% - Ref. 25208 - 1L**  
**(n. incl.)**

**ABRE BURACOS**  
TALADRO DE TIERRA  
GROUND AUGER

**3 BROCAS (INCLUÍDAS)**  
3 DRILL (INCLUDED)

**COM SISTEMA DE SEGURANÇA**  
CON SISTEMA DE SEGURIDAD  
WITH SECURITY SYSTEM



Capacidade máxima: Ø200 mm  
OPCIONAL » Medidas disponíveis:  
Ø 80, 100, 150, 200mm (x 700mm)

Capacidad máxima: Ø200 mm  
Opcional » Tamaños disponibles:  
Ø 80, 100, 150, 200mm (x 700mm)  
Maximum capacity: Ø200 mm  
Optional » Available sizes:  
Ø 80, 100, 150, 200mm (x 700mm)

**51.2 cc**

**51.2 cc**

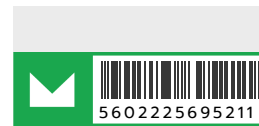

Potência / Potencia / Power	<b>23 kW</b>	<b>23 kW</b>
RPM	<b>4200</b>	<b>3200</b>
Depósito Combustível / Depósito Combustible / Fuel Tank	<b>500 mL</b>	<b>500 mL</b>
Caixa Transmissão / Caja Transmisión / Gear Box	<b>34:1</b>	<b>34:1</b>
Broca / Taladro / Drill		<b>Ø 100 - 150 - 200 (x 700mm)</b>
Ruído / Noise	<b>108 db(A)</b>	<b>108 db(A)</b>



**2T - Gasolina Mix 4%**  
2T - Gasoline Mix 4%

**Mix 4% - Ref. 25208 - 1L**  
(n. incl.)

N. Ref.	Descrição	Marca	Quant. Caixa
69522	ABRE BURACOS-MGD-512CC 3BROCA	MADER GARDEN TOOLS	1/1
69521	ABRE BURACOS-MGD-512CC 3BROCA	MADER GARDEN TOOLS	1/1

## BROCA PARA ABRE BURACOS BROCA PARA TALADRO DE TIERRA DRILL GROUND AUGER

### UNIVERSAL



800 mm

Ø 100 mm

Ø 150 mm

Ø 200 mm



800 mm

**REFORÇADA  
REFORZADA  
REINFORCED**



Ø 100 mm

Ø 150 mm

Ø 200 mm



Encaixe / Encaje / Fitting

Ø 20mm

N. Ref.	Descrição	Marca	Quant. Caixa
69218	BROCA ABRE BURAC-MGD-100X800MM	MADER GARDEN TOOLS	1
69219	BROCA ABRE BURAC-MGD-150X800MM	MADER GARDEN TOOLS	1
69220	BROCA ABRE BURAC-MGD-200X800MM	MADER GARDEN TOOLS	1
69301	BROCA REFORÇADA 100X800MM	MADER GARDEN TOOLS	1
69302	BROCA REFORÇADA 150X800MM	MADER GARDEN TOOLS	1
69303	BROCA REFORÇADA 200X800MM	MADER GARDEN TOOLS	1

## LÂMINA DE SUBSTITUIÇÃO LÂMINA DE SUBSTITUCION REPLACEMENT BLADE

para Broca Reforçada  
para Broca Reforzada  
for Reinforced Drill



Ø 100mm

Ø 150mm

Ø 200mm

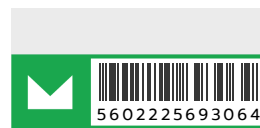

N. Ref.	Descrição	Marca	Quant. Caixa
69304	LÂMINA DE SUBSTITUIÇÃO 100	MADER GARDEN TOOLS	5
69305	LÂMINA DE SUBSTITUIÇÃO 150	MADER GARDEN TOOLS	12
69306	LÂMINA DE SUBSTITUIÇÃO 200	MADER GARDEN TOOLS	5

## CARRO PARA ABRE BURACOS CARRETILLA PARA TALADRO DE TIERRA TROLLEY FOR GROUND AUGER

Controlo da máquina no punho  
Control de la máquina en el mango  
Machine control on the handle



Pega Dupla  
Manija Doble  
Double Handle

ARTICULADO  
ARTICULATED



Caixa para Ferramenta  
Caja de Herramientas  
Tool Box

Roda / Rueda / Wheel **300 - 8**

N. Ref.	Descrição	Marca	Quant. Caixa
69194	CARRO P/ABRE BURAC-MGD-PEG DUP	MADER GARDEN TOOLS	1

## EXTENSOR EXTENSIÓN EXTENSION BAR

PARA ABRE BURACOS  
DE TALADRO DE TIERRA  
FOR GROUND AUGER



**30 cm**



N. Ref.	Descrição	Marca	Quant. Caixa
69193	EXTENSOR 30CM-MGD-P/ABRE BURAC	MADER GARDEN TOOLS	1/20

## AMORTECEDOR AMORTIGUADOR SHOCK ABSORVER

PARA ABRE BURACOS  
DE TALADRO DE TIERRA  
FOR GROUND AUGER

**UNIVERSAL**

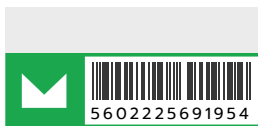

N. Ref.	Descrição	Marca	Quant. Caixa
69195	AMORTECEDOR-MGD-P/ABRE BURACOS	MADER GARDEN TOOLS	1

## EXTENSÃO ELÉTRICA PROLONGADOR ELÉCTRICO ELECTRICAL EXTENSION

EXTERIOR  
OUTSIDE

**10m**  
3G x 1.0mm<sup>2</sup>

**25m**  
3G x 1.0mm<sup>2</sup>



**10m**  
3G x 1.5mm<sup>2</sup>

**20m**  
3G x 1.5mm<sup>2</sup>

**25m**  
3G x 1.5mm<sup>2</sup>

**30m**  
3G x 1.5mm<sup>2</sup>

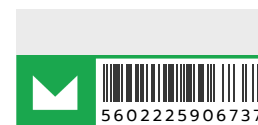

N. Ref.	Descrição	Marca	Quant. Caixa
90672	EXT FIO ELE-MGD-10MX1MM S/ENR	MADER GARDEN TOOLS	20/20
90671	EXT FIO ELE-MGD-25MX1MM	MADER GARDEN TOOLS	10/10
90676	EXT ELE-MHM-10MT 3GX1,5MM	MADER HOME TOOLS	1/20
90677	EXT ELE-MHM-20MT 3GX1,5MM	MADER HOME TOOLS	10/10
90686	EXT ELE-MHM-25M 3GX1,5MM LARAN	MADER HOME TOOLS	10/10
90673	EXT FIO ELE-MGD-30MX15MM S/EN	MADER GARDEN TOOLS	8/8

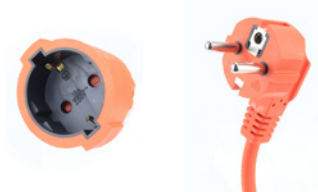

## EXTENSÃO ELÉTRICA PROLONGADOR ELÉCTRICO ELECTRICAL EXTENSION

EXTERIOR  
OUTSIDE

ENROLADOR  
ENROLLACABLE  
CABLE REEL



**25m**  
3G x 1.5mm<sup>2</sup>

**50m**  
3G x 1.5mm<sup>2</sup>



N. Ref.	Descrição	Marca	Quant. Caixa
90674	EXT ELE-MGD-25MT P/EXTERIOR	MADER GARDEN TOOLS	4/4
90675	EXT ELE-MGD-50MT P/EXTERIOR	MADER GARDEN TOOLS	2/2

### APARADOR DE RELVA CORTABORDES GRASS TRIMMER



**250W**  
220mm

RPM	12 000
Tensão / Tensión / Voltage	230V-50Hz
Fio / Hilo / Wire	1mm x 5m

N. Ref.	Descrição	Marca	Quant. Caixa
69391	APARADOR RELVA-MGD-250W-220MM	MADER GARDEN TOOLS	15

### APARADOR DE RELVA CORTABORDES GRASS TRIMMER

**EXTENSÍVEL**  
**EXTENSIBLE**

**1040 » 1200 mm**

**CABEÇA ARTICULADA**  
CABEZA ARTICULADA  
ARTICULATED HEAD



**FIO NYLON**  
HILO NYLON  
NYLON CUTTER

**C/ RODA**  
C/ RUEDA  
W/ WHEEL

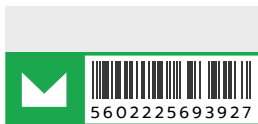

**600W**  
320mm

RPM	9300
Tensão / Tensión / Voltage	230V-50Hz
Fio / Hilo / Wire	15mm x 4m
Extensível / Extensible	1040 » 1200 mm

N. Ref.	Descrição	Marca	Quant. Caixa
69392	APARADOR RELVA-MGD-600W-320MM	MADER GARDEN TOOLS	4



**ELÉTRICO**  
ELECTRICO  
ELECTRIC

### BOBINE FIO NYLON BOBINA HILO NYLON NYLON WIRE REEL

para Aparador Relva  
para Cortabordes  
for Grass Trimmer



»69392



»69249  
»69391



6m  
1.6mm



»69390

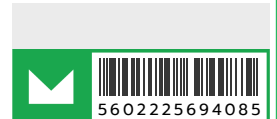

N. Ref.	Descrição	Marca	Quant. Caixa
MAR424344	MAR-GT600D-KIT BOBINE FIO NYL	MADER GARDEN TOOLS	-
69318	BOBINE FIO-MGD-P/APARAD 69249	MADER GARDEN TOOLS	500
69408	BOBINE FIO-MGD-NYLON 1.6MMX6M	MADER GARDEN TOOLS	4

### TAMPA PARA BOBINE FIO NYLON CUBIERTA PARA BOBINA DE HILO NYLON COVER FOR NYLON WIRE SPOOL

Bobine Fio Nylon » Aparador  
Bobina Hilo Nylon » Cortabordes  
Nylon Wire Spool » Grass Trimmer



69257

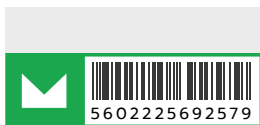

5602225692579

69256 » Bobine

para Aparador » 69252  
para Cortabordes » 69252  
for Grass Trimmer » 69252

N. Ref.	Descrição	Marca	Quant. Caixa
69257	TAMPA-MGD-P/BOBINE FIO APARAD	MADER GARDEN TOOLS	200

### MOTOR PARA APARADOR MOTOR PARA CORTABORDES GRASS TRIMMER ENGINE



69399



5602225693996

250W



Para Modelo / Para El Modelo / For Model **69391**

N. Ref.	Descrição	Marca	Quant. Caixa
69399	MOTOR P/APARADOR RELVA 69391	MADER GARDEN TOOLS	100

**ROÇADORA**  
**DESBROZADORA**  
**BRUSH CUTTER**

**Proteção do depósito em metal**  
 Protector del tanque de metal  
 Metal tank protection



**25.4 cc**  
 Ø 26 x 1520mm

<b>Potência / Potencia / Power</b>	<b>0.7 kW</b>
<b>RPM</b>	<b>7500</b>
<b>Depósito Combustível / Depósito Combustible / Fuel Tank</b>	<b>0.5 L</b>
<b>Arranque / Start System</b>	<b>Manual</b>
<b>Acessórios / Accesorios / Accessories</b>	<b>Suspensório</b>
<b>Bobine / Bobina / Trimmer_Head</b>	<b>Nylon - 7500rpm</b>
<b>Ruído / Noise</b>	<b>114 db</b>

N. Ref.	Descrição	Marca	Quant. Caixa
69612	ROÇADORA-MGD-25,4CC	MADER GARDEN TOOLS	1



**2T - Gasolina Mix 4%**  
**2S - Gasoline Mix 4%**

**Mix 4% - Recom. ref. 25208**

**ROÇADORA**  
**DESBROZADORA**  
**BRUSH CUTTER**

**ANTI-VIBRAÇÃO**  
**ANTIVIBRACIÓN**  
**ANTI-VIBRATION**

**Regulação Fácil do Guiador**  
 Fácil regulación del manillar  
 Easy regulation handlebar



**Cabeça Roçadora » JAPAN**  
 Cabeza Desbrozadora » JAPAN  
 Brush Cutter Gear Box » JAPAN



49279



5602225492797

**52 cc**  
 Ø 28 x 1500mm

<b>Potência / Potencia / Power</b>	<b>145kW</b>
<b>RPM</b>	<b>6500</b>
<b>Depósito Combustível / Depósito Combustible / Fuel Tank</b>	<b>12L</b>
<b>Bobine / Bobina / Trimmer_Head</b>	<b>Nylon</b>
<b>Disco / Blade</b>	<b>(40) - Ø 255 x 254 x 3 mm</b>
<b>Ruído / Noise</b>	<b>114 db</b>

N. Ref.	Descrição	Marca	Quant. Caixa
49279	ROÇADORA-MGD-52CC ANTI-VIBRA	MADER GARDEN TOOLS	1

**2T - Gasolina Mix 4%**  
**2S - Gasoline Mix 4%**

**Mix 4% - Recom. ref. 25208 - 1L**  
**(n. incl.)**

**ROÇADORA**  
**DESBROZADORA**  
**BRUSH CUTTER**

**ANTI-VIBRAÇÃO**  
**ANTIVIBRACIÓN**  
**ANTI-VIBRATION**

**REGULAÇÃO FÁCIL DO GUIADOR**  
**FÁCIL REGULACIÓN DEL MANILLAR**  
**EASY REGULATION HANDLEBAR**

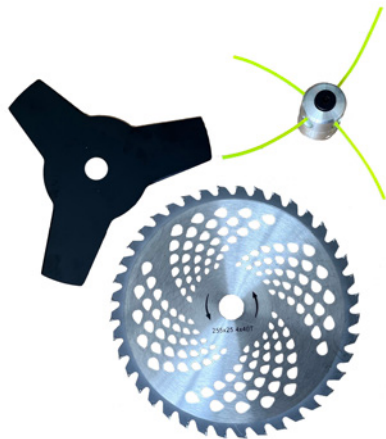

Disco | Blade

**2 un (3D + 40D)**

Bobine Nylon | Bobina Nylon | Trimmer Head

**2 un (Plastico + Metal)**

Suspensório Duplo | Arnes Doble | Double Suspenders

**1 un**

Viseira de Proteção | Protector Facial

| Mesh Face Shield

**1 un**

Auscultadores de Proteção | Auriculares de Protección

| Protection Headphones

**1 un**

Luvas de Proteção | Guantes de Protección

| Protection Gloves

**1 un**



**51.7 cc**

**Ø 28 x 1650mm**

<b>Potência / Potencia / Power</b>	<b>14 kW</b>
<b>RPM</b>	<b>9000</b>
<b>Depósito Combustível / Depósito Combustible / Fuel Tank</b>	<b>12 L</b>
<b>Arranque / Start System</b>	<b>Manual</b>
<b>Pega / Manija / Handle</b>	<b>Dupla</b>
<b>Disco / Blade</b>	<b>(3) - Ø 255 x 25.4 x 14 mm</b>
	<b>(40) - Ø 255 x 25.4 x 3 mm</b>
<b>Ruído / Noise</b>	<b>114 dB (A)</b>

N. Ref.	Descrição	Marca	Quant. Caixa
69614	ROÇADORA-MGD-517CC 28MM 1.4KW	MADER GARDEN TOOLS	1/1

**2T - Gasolina Mix 4%**  
**2S - Gasoline Mix 4%**



**Mix 4% - Ref. 25208 - 1L**  
**(n. incl.)**

**ROÇADORA**  
DESBROZADORA  
BRUSH CUTTER

**ANTI-VIBRAÇÃO**  
ANTIVIBRACIÓN  
ANTI-VIBRATION

**REGULAÇÃO FÁCIL DO GUIADOR**  
FÁCIL REGULACIÓN DEL MANILLAR  
EASY REGULATION HANDLEBAR



**2 DISCOS + 1 NYLON**  
2 BLADES + 1 NYLON



69613



5602225696133

**51.7 cc**  
Ø 28 x 1650mm

<b>Potência / Potencia / Power</b>	<b>147 kW</b>
<b>RPM</b>	<b>7500</b>
<b>Depósito Combustível / Depósito Combustible / Fuel Tank</b>	<b>12 L</b>
<b>Arranque / Start System</b>	<b>Manual</b>
<b>Pega / Manija / Handle</b>	<b>Dupla</b>
<b>Acessórios / Accesorios / Accessories</b>	<b>Suspensório</b>
<b>Bobine / Bobina / Trimmer_Head</b>	<b>Nylon</b>
<b>Disco / Blade</b>	<b>(40) - Ø 255 x 25.4 x 3 mm</b>
	<b>(3) - Ø 255 x 25.4 x 14 mm</b>
<b>Ruído / Noise</b>	<b>114 dB (A)</b>



**2T - Gasolina Mix 4%**  
**2S - Gasoline Mix 4%**

**Mix 4% - Ref. 25208 - 1L**  
**(n. incl.)**

N. Ref.	Descrição	Marca	Quant. Caixa
69613	ROÇADORA-MGD-52CC 28MM ANT-VIB	MADER GARDEN TOOLS	1/1

# MADER®

# GARDEN TOOLS

## ROÇADORA DESBROZADORA BRUSH CUTTER

ARNÊS ALÇA DUPLA MAIS CONFORTO  
PUNHO ERGONÓMICO  
UNIÃO DE GUIADOR REFORÇADO  
ARRANQUE SUAVE

ARNÊS REFORZADO  
EMPUÑADURA ERGONÓMICA  
UNIÓN DEL MANILLAR REFORZADA  
ARRANQUE SUAVE

DOUBLE-STRAP HARNESS FOR GREATER  
COMFORT HANDLE

REINFORCED HANDLEBAR JOINT  
EASY START



CABEÇA DO MOTOR REFORÇADA  
CABEZA DEL MOTOR REFORZADA  
REINFORCED ENGINE BLOCK



**51.7cc**

Ø 28 x 1500mm



CABEÇA JAPONESA ALTA QUALIDADE  
CABEZA JAPONESA DE ALTA CALIDAD  
HIGH-QUALITY JAPANESE HEAD

Potência / Potencia / Power	13Kw
RPM	7500
Depósito Combustível / Depósito Combustible / Fuel Tank	12L
Arranque / Start System	Manual
Bobine / Bobina / Trimmer_Head	Nylon
Disco / Blade	(3) - Ø 255 x 25.4 x 1.4 mm
Ruído / Noise	117 db(A)

N. Ref.	Descrição	Marca	Quant. Caixa
69610	ROÇADORA-MGD-51.7CC 28MM	MADER GARDEN TOOLS	1/1



2T - Gasolina Mix 4%  
2S - Gasoline Mix 4%

Mix 4% - Ref. 25208 - 1L  
(n. incl.)

MADER

TRABALHA COMO UM PROFISSIONAL

26MAR27

## ROÇADORA DESBROZADORA BRUSH CUTTER

## PROFISSIONAL PROFESIONAL PROFESIONAL

## KAWASAKI



**Regulação Fácil do Guiador**  
Fácil regulación del manillar  
Easy regulation handlebar



**KAWASAKI**  
Japanese Engine



**2T - Gasolina Mix 4%**  
2S - Gasoline Mix 4%

**Mix 4% - Ref. 25208 - 1L**  
(n. incl.)



**45.4cc**

Ø 28 x 1500mm

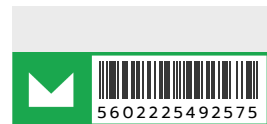
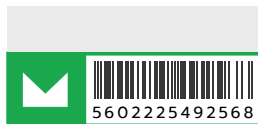

<b>Potência / Potencia / Power</b>	<b>142 kW</b>	<b>2.0kW</b>
<b>RPM</b>	<b>7500</b>	<b>8500</b>
<b>Depósito Combustível / Depósito Combustible / Fuel Tank</b>	<b>1.2L</b>	<b>1.2L</b>
<b>Bobine / Bobina / Trimmer_Head</b>	<b>Nylon</b>	<b>Nylon</b>
<b>Disco / Blade</b>	<b>(3) - Ø 300 x 25.4 x 3 mm</b>	<b>(3) - Ø 300 x 25.4 x 3 mm</b>
<b>Ruído / Noise</b>	<b>110 db(A)</b>	<b>114 db(A)</b>

N. Ref.	Descrição	Marca	Quant. Caixa
49256	ROÇADOURA-MGD-45.4CC PNBC450	MADER GARDEN TOOLS	1
49257	ROÇADOURA-MGD-53.2CC PNBC530	MADER GARDEN TOOLS	1

**ROÇADORA**  
**DESBROZADORA**  
**BRUSH CUTTER**

**PROFISSIONAL**  
**PROFESIONAL**  
**PROFESSIONAL**

**4 T**



**Regulação Fácil do Guiador**  
 Fácil regulación del manillar  
 Easy regulation handlebar



**33.5 cc**  
 Ø 28 x 1500mm

<b>Potência / Potencia / Power</b>	<b>0.8 kW</b>
<b>RPM</b>	<b>6500</b>
<b>Depósito Combustível / Depósito Combustible / Fuel Tank</b>	<b>760 mL</b>
<b>Cárter / Crankcase</b>	<b>0.5L (10W40 / 15W40 / SAE30)</b>
<b>Arranque / Start System</b>	<b>Manual</b>
<b>Bobine / Bobina / Trimmer_Head</b>	<b>Nylon</b>
<b>Disco / Blade</b>	<b>(3) - Ø 255 x 25.5 x 1.4 mm</b>
<b>Ruído / Noise</b>	<b>120 db</b>

N. Ref.	Descrição	Marca	Quant. Caixa
49267	ROÇADOURA-MGD-33,5CC	MADER GARDEN TOOLS	1



**4T - Gasolina 95**  
**4S - Gasoline 95**

**Óleo (não incluído)**  
**Aceite (no incluido)**  
**Oil (not included)**

**10W40 - Ref. 25203 - 1 L**

**ROÇADORA**  
**DESBROZADORA**  
**BRUSH CUTTER**

**MULTIFUNÇÕES**  
**MULTIFUNCIONES**  
**MULTIFUNCTIONS**



**Descanso do Motor**  
 Descanso de Motor  
 Engine Stand

**Proteção do Depósito**  
 Protección del depósito  
 Deposit Protection



**2 TRANSM.**



**42.7 cc**  
 Ø 26 mm

<b>Transmissão / Transmisión / Transmission</b>	<b>2 - Ø 8 mm</b>
<b>Potência / Potencia / Power</b>	<b>125 kW</b>
<b>RPM</b>	<b>9000</b>
<b>Depósito Combustível / Depósito Combustible / Fuel Tank</b>	<b>12 L</b>
<b>Arranque / Start System</b>	<b>Manual</b>
<b>Bobine / Bobina / Trimmer_Head</b>	<b>Nylon - 7 600 r.p.m.</b>
<b>Disco / Blade</b>	<b>(3) - Ø 255 x 25.4 x 14 mm</b>
<b>Ruído / Noise</b>	<b>114 db(A)</b>

N. Ref.	Descrição	Marca	Quant. Caixa
49255	ROÇADOURA-MGD-42,7CC 2TRANSMIS	MADER GARDEN TOOLS	1

**Veio: Ø 8mm, Encaixe: 5mm**  
 Eje: Ø 8mm, Encaje: 5mm  
 Axis: Ø 8mm, Slot: 5mm

**2T - Gasolina Mix 4%**  
**2S - Gasoline Mix 4%**

**Mix 4% - Ref. 25208 - 1L**  
**(n. incl.)**



**ROÇADORA**  
DESBROZADORA  
BRUSH CUTTER



**2 TRANSM.**

**MULTIFUNÇÕES**  
MULTIFUNCIONES  
MULTIFUNCTIONS

**5 IN 1**

**ROÇADORA**  
**PODADORA**  
**CORTA-SEBES**  
**PODADORA DE ALTURA**  
**CORTA-SEBES DE ALTURA**

**Veio: Ø 8mm, Encaixe: 5mm**  
Eje: Ø 8mm, Encaje: 5mm  
Axis: Ø 8mm, Slot: 5mm



**Descanso do Motor**  
Descanso de Motor  
Engine Stand



**Proteção do Depósito**  
Protección del Depósito  
Deposit Protection

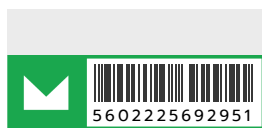

**42,7 cc**  
Ø 26mm



**2T - Gasolina Mix 4%**  
2S - Gasoline Mix 4%

**Mix 4% - Ref. 25208 - 1L**  
Mix 4% - Ref. 25208 - 1L  
**(n. incl.)**



<b>Transmissão / Transmisión / Transmission</b>	<b>2 » Ø 8 mm</b>
<b>Potência / Potencia / Power</b>	<b>125 kW</b>
<b>RPM</b>	<b>9000</b>
<b>Depósito Combustível / Depósito Combustible / Fuel Tank</b>	<b>12 L</b>
<b>Bobine / Bobina / Trimmer_Head</b>	<b>Nylon - 7 600 r.p.m.</b>
<b>Disco / Blade</b>	<b>(3) - 255 x 25.4 x 1.4 mm</b> <b>- 8400 rpm</b>
<b>Podadora / Chain Saw</b>	<b>250mm</b>
<b>Corta Sebes / Cortasetos / Hedge Cutter</b>	<b>430 mm</b>
<b>Extensão / Extensión / Extension</b>	<b>1 000 mm</b>
<b>Ruído / Noise</b>	<b>114 db</b>

N. Ref.	Descrição	Marca	Quant. Caixa
69295	ROÇADOURA MULTI-MGD-5EM1	MADER GARDEN TOOLS	1

**PODADORA DE ALTURA**  
 PODADORA DE ALTURA  
 HEIGHT PRUNER

**MULTIFUNÇÕES**  
 MULTIFUNCIONES  
 MULTIFUNCTIONS

**1.5 » 3.0 m**

**Veio Extensor**  
 Eje Extensor  
 Extensor Shaft

**3 TRANSM.**

**Veio: Ø 8mm, Encaixe: 5mm**  
 Eje: Ø 8mm, Encaje: 5mm  
 Axis: Ø 8mm, Slot: 5mm

**Proteção do Depósito**  
 Protección del Depósito  
 Deposit Protection

**Descanso do Motor**  
 Descanso de Motor  
 Engine Stand



**25,4 cc**  
 Ø 26mm

<b>Transmissão / Transmisión / Transmission</b>	<b>3 » Ø 8 mm</b>
<b>Potência / Potencia / Power</b>	<b>0.7 kW</b>
<b>RPM</b>	<b>7500</b>
<b>Depósito Combustível / Depósito Combustible / Fuel Tank</b>	<b>12 L</b>
<b>Podadora / Chain Saw</b>	<b>250mm</b>
<b>Extensão / Extensión / Extension</b>	<b>1 500 mm</b>
<b>Ruído / Noise</b>	<b>110 db</b>

N. Ref.	Descrição	Marca	Quant. Caixa
69350	PODADORA ALTURA-MGD-25.4CC 3M	MADER GARDEN TOOLS	1



**2T - Gasolina Mix 4%**  
 2S - Gasoline Mix 4%

**Mix 4% - Ref. 25208 - 1L**  
 (n. incl.)

## ROÇADORA DESBROZADORA BRUSH CUTTER



**MOCHILA  
BAG PACK**

**MULTIFUNÇÕES  
MULTIFUNCIONES  
MULTIFUNCTIONS**



**1 TRANSM.**

**Cabeça Fixa**  
Cabeza Fija  
Fixed Head

**2T - Gasolina Mix 4%**  
2S - Gasoline Mix 4%

**Mix 4% - Ref. 25208 - 1L**  
(n. incl.)

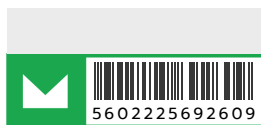

**42.7 cc**  
Ø 26 mm



**2 TRANSM.**

**Veio: Ø 8mm, Encaixe: 5mm**  
Eje: Ø 8mm, Encaje: 5mm  
Axis: Ø 8mm, Slot: 5mm

**42.7 cc**  
Ø 26 mm

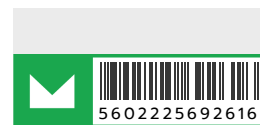

Ref.	M200	M500
<b>Potência / Potencia / Power</b>	<b>125 kW</b>	<b>125 kW</b>
<b>RPM</b>	<b>8500</b>	<b>8500</b>
<b>Depósito Combustível / Depósito Combustible / Fuel Tank</b>	<b>12 L</b>	<b>12 L</b>
<b>Arranque / Start System</b>	<b>Manual</b>	<b>Manual</b>
<b>Bobine / Bobina / Trimmer_Head</b>	<b>Nylon</b>	<b>Nylon</b>
<b>Disco / Blade</b>	<b>(3) - Ø 255 x 25.4 x 14 mm</b> - 7 800 rpm	<b>(3) - Ø 255 x 25.4 x 14 mm</b> - 7 800 rpm
<b>Ruído / Noise</b>	<b>110 db(A)</b>	<b>110 db(A)</b>

N. Ref.	Descrição	Marca	Quant. Caixa
69260	ROÇADOURA MOCH-MGD-42,7CC M200	MADER GARDEN TOOLS	1
69261	ROÇADOURA MOCH-MGD-42,7CC M500	MADER GARDEN TOOLS	1

**ROÇADORA  
DESBROZADORA  
BRUSH CUTTER**

**MOCHILA  
BAG PACK**



**KAWASAKI**  
Japanese Engine

**MULTIFUNÇÕES  
MULTIFUNCIONES  
MULTIFUNCTIONS**



**1 TRANSM.**



**45.4 cc**  
Ø 26 mm



**53.2 cc**  
Ø 26 mm



5602225696119



5602225693095



**Veio: Ø 8mm, Encaixe: 5mm**  
Eje: Ø 8mm, Encaje: 5mm  
Axis: Ø 8mm, Slot: 5mm

<b>Potência / Potencia / Power</b>	<b>16 kW</b>	<b>2.0 kW</b>
<b>RPM</b>	<b>9800</b>	<b>9300</b>
<b>Depósito Combustível / Depósito Combustible</b>	<b>1.2 L</b>	<b>1.2 L</b>
<b>Arranque / Start System</b>	<b>Manual</b>	<b>Manual</b>
<b>Bobine / Bobina / Trimmer_Head</b>	<b>Nylon</b>	<b>Nylon</b>
<b>Disco / Blade</b>	<b>Metal (3)</b>	<b>Metal (3)</b>
<b>Ruído / Noise</b>	<b>112 db</b>	<b>110 db(A)</b>



**2T - Gasolina Mix 4%**

**Mix 4% - Ref. 25208 - 1L**  
(n. incl.)

N. Ref.	Descrição	Marca	Quant. Caixa
69611	ROÇAD MOCH-MGD-45.4CC KAWASAKI	MADER GARDEN TOOLS	1
69309	ROÇAD MOCH-MGD-53.2CC KAWASAKI	MADER GARDEN TOOLS	1

**ROÇADORA**  
**DESBROZADORA**  
**BRUSH CUTTER**

**com RODAS**  
**con RUEDAS**  
**with WHEELS**

**52 cc**  
 Ø 28 mm



**com FILTRO AR » ELEVADO**  
**con FILTRO AIRE » ALTO**  
**with AIR FILTER » HIGH**



**Braço Reforçado**  
**Bravo reforzado**  
**Reinforced Arm**



<b>Potência / Potencia / Power</b>	<b>145 kW</b>
<b>RPM</b>	<b>7500</b>
<b>Depósito Combustível / Depósito Combustible / Fuel Tank</b>	<b>1L</b>
<b>Bobine / Bobina / Trimmer_Head</b>	<b>Nylon</b>
<b>Disco / Blade</b>	<b>Metal (3)</b>
<b>Ruído / Noise</b>	<b>111 db(A)</b>



**2T - Gasolina Mix 4%**

**Mix 4% - Recom. ref. 25208 - 1L (n. incl.)**

N. Ref.	Descrição	Marca	Quant. Caixa
69620	ROÇAD RODAS-MGD-52CC DUPL 28MM	MADER GARDEN TOOLS	1

## ROÇADORA DESBROZADORA BRUSH CUTTER

com RODAS  
con RUEDAS  
with WHEELS

### 3 Posições de Corte | Posiciones de Corte | Cutting Positions

Frente | Frontal | Front  
40° - Esquerda | Izquierda | Left  
40° - Direita | Derecha | Right



COM FILTRO AR » ELEVADO  
CON FILTRO AIRE » ALTO  
WITH AIR FILTER » HIGH



52 cc  
Ø 26 mm



Potência / Potencia / Power	145 kW
RPM	7500
Depósito Combustível / Depósito Combustible / Fuel Tank	1L
Bobine / Bobina / Trimmer_Head	Nylon
Disco / Blade	Metal (3)
Ruído / Noise	114 db(A)

N. Ref.	Descrição	Marca	Quant. Caixa
69621	ROÇAD RODAS-MGD-52CC DUPL 3POS	MADER GARDEN TOOLS	1/1



2T - Gasolina Mix 4%  
Mix 4% - Ref. 25208 - 1L  
(n. incl.)

## FILTRO DE AR ALTO FILTRO DE AIRE ALTO HIGH AIR FILTER

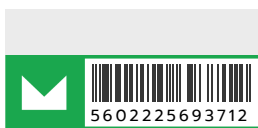

para Ref.:  
69329, 69330, 69331

N. Ref.	Descrição	Marca	Quant. Caixa
69371	FILTRO AR ALTO P/ROÇADOR RODAS	MADER GARDEN TOOLS	12

## MOTOR MULTIFUNÇÕES MOTOR MULTIFUNCIÓN MULTIFUNCTION ENGINE

DESCANSO DO MOTOR  
DESCANSO DE MOTOR  
ENGINE STAND



COMPATÍVEL COM TODOS OS ACESSÓRIOS MADER GARDEN  
COMPATIBLE CON TODOS LOS ACCESORIOS MADER GARDEN  
COMPATIBLE WITH ALL MADER GARDEN ACCESSORIES



69600

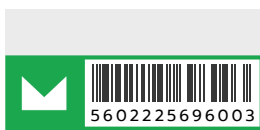

5602225696003

**25.4 cc**  
Ø 26 mm

Potência / Potencia / Power	<b>0.7 kW</b>
RPM	<b>7500</b>
Depósito Combustível / Depósito Combustible / Fuel Tank	<b>0.5 L</b>
Arranque / Start System	<b>Manual</b>
Transmissão / Transmisión / Transmission	<b>Veio: Ø 8mm, Encaixe: 5mm</b>
Ruído / Noise	<b>112 db(A)</b>

N. Ref.	Descrição	Marca	Quant. Caixa
69600	MOTOR MULTI FUNÇ-MGD-25.4CC	MADER GARDEN TOOLS	1/1



2T - Gasolina Mix 4%  
2S - Gasolina Mix 4%

Mix 4% - Ref. 25208

## CABEÇA COMPLETA CABEÇA COMPLETA FULL GEAR BOX

Para 69261, 49255, 69295, 69350 e 69297  
For 69261, 49255, 69295, 69350 and 69297

Eixo 8mm  
Encaixe 5mm  
Eje 8mm  
Encaje 5mm  
Axis 8mm  
Slot 5mm



69231



5602225692319

**430 mm**

## ESCARIFICADOR ESCARIFICADOR ROTARY CUTTER



69205



5602225692050

N. Ref.	Descrição	Marca	Quant. Caixa
69231	CABEÇA COMPLETA P/ROÇ MOCHILA	MADER GARDEN TOOLS	1/1
69205	ACE ESCARIFICADOR-MGD-P/ROÇAD	MADER GARDEN TOOLS	1/1

**ACESSÓRIOS » ROÇADORA**  
**ACCESORIOS » DESBROZADORA**  
**ACCESSORIES » BRUSH CUTTER**

Compatível  
 Compatible  
 Compatible

69261  
 49255  
 69295  
 69350  
 69297

φ 8mm » Veio/Eixo /Eje /Axis  
 ◇ 5mm » Encaixe /Encaje /Slot



**ARTICULADA**  
**ARTICULADO**  
**ARTICULATED**



**550 mm**

**Corta-Sebes**  
**Cortasetos**  
**Hedge Trimmer**

**Motobomba**  
**Water Pump**



**718mm**  
**25 mm-1"**

**Varejador**  
**Vareador**  
**Olive Shaker**



**710mm**

**Extensão**  
**Extensión**  
**Extension**



**1m**

**Podadora**  
**Pole Saw**



**250mm**

Descrição: **Acessórios p/ Roçadora**

Marca: **Mader Garden**

N. Ref.	Especificação	Quant.	Caixa:
69208	Corta-Sebes - 550 mm - Articulada	1	
69235	Motobomba - 1"	1	
69204	Varejador - 710 mm	1	
69232	Extensão - 1 m	1/10	
69207	Podadora - 250 mm	1	
69206	Podadora - 300 mm - Articulada	1	

**ARTICULADA**  
**ARTICULADO**  
**ARTICULATED**



**Podadora**  
**Pole Saw**



**300 mm**

**TUBO » ROÇADORA**  
**TUBO » DESBROZADORA**  
**WORKING POLE » BRUSH CUTTER**



**TRANSMISSÃO COMPLETA**  
**TRANSMISSION COMPLETA**  
**FULL DRIVE**

Disponível em SAURIUM



**9D**  
 $\phi$  28 mm

Made in JAPAN

Descrição: Transmissão p/ Roçadora  
 Marca: Mader Garden  
 N. Ref. Especificação Quant. Caixa:  
 49281 Tubo -  $\phi$  28mm - c/ Cabeça 9 D. 1

**TRANSMISSÃO COMPLETA » ROÇADORA**  
**TRANSMISSION COMPLETA » DESBROZADORA**  
**FULL DRIVE » BRUSH CUTTER**



Descrição: Transmissão p/ Roçadora  
 Marca: Mader Garden  
 N. Ref. Especificação Quant. Caixa:  
 69328 Completa 1



p/ | to  
 69261

**TRANSMISSÃO FLEXÍVEL » ROÇADORA**  
**TRANSMISSION FLEXIBLE » DESBROZADORA**  
**FLEXIBLE DRIVE » BRUSH CUTTER**

p/ | to  
 69260  
 69261



**INTERNA**  
**INTERNAL**



Descrição: Transmissão Flexível  
 Marca: Mader Garden  
 N. Ref. Especificação Quant. Caixa:  
 69224 Interna 10  
 69223 Completa 12



**COMPLETA**  
**FULL**



**DEPÓSITO DE COMBUSTÍVEL» ROÇADORA**  
**TANQUE DE COMBUSTIBLE » DESBROZADORA**  
**FUEL TANK » BRUSH CUTTER**



p/43cc - 52cc

Descrição: Depósito Combustível

Marca: Mader Garden

N. Ref.	Especificação	Quant. Caixa:
03700	p/ Roçadora	30
03709	p/ Roçadora 69330/49279	30
03407	p/ Roçadora 69330	1

**4**  
FUROS /HOYO /HOLE



p/69330 - 49279



p/69330

**CARBURADOR » ROÇADORA**  
**CARBURADOR » DESBROZADORA**  
**CARBURETOR » BRUSH CUTTER**



**43cc**



Descrição: Carburador p/ Roçadora

Marca: Mader Garden

N. Ref.	Especificação	Quant. Caixa:
69280	43 cc	100

**SISTEMA DE ARRANQUE » ROÇADORA**  
**SISTEMA DE ARRANQUE » DESBROZADORA**  
**STARTING SYSTEM » BRUSH CUTTER**



**Copo Metálico**  
**Vaso Metálico**  
**Metal Cup**



Descrição: Sistema de Arranque

Marca: Mader Garden

N. Ref.	Especificação	Quant. Caixa:
69276	Copo p/ Sistema de Arranque	200
03439	p/ Roçad. (49267) - Motor 4T	1
69275	p/ Roçadora	100



### SISTEMA DE ARRANQUE MANUAL SISTEMA DE ARRANQUE MANUAL MANUAL STARTING SYSTEM



**PARA / FOR:**  
**48426**

**ROÇADORA 52CC**  
DESBRUZADORA 52CC | 52CC BRUSH CUTTER



**ARRANQUE SUAVE**  
SMOOTH START

**PARA / FOR:**  
**ROÇADORA 52CC**  
DESBRUZADORA 52CC  
52CC BRUSH CUTTER



**PARA / FOR:**

**ROÇADORA**  
DESBRUZADORA | BRUSH CUTTER  
**49256 Kawasaki**



**PARA / FOR:**  
**ROÇADORA**  
DESBRUZADORA | BRUSH CUTTER  
**49257 Kawasaki**



**PARA / FOR:**

**MOTOBOMBA** | WATER PUMP  
**49507**



**PARA / FOR:**  
**ATOMIZADOR**  
GARDEN SPRAYER  
**49105**  
**49107**  
**49181**  
**69085**

Descrição: Sistema de Arranque

Marca: Mader Garden

N. Ref.	Especificação	Quant. Caixa:
69430	Arr Suave P/ Roçadora 52CC	100
69431	P/ Roçadora 48426	50
69432	P/ Roçadora 49257 Kawasaki	100
69433	P/ Roçadora 49256 Kawasaki	50
44575	P/ Motobomba	20
49131	P/ Atomizador	50

## PUNHO SIMPLES PARA ROÇADORA EMPUÑADURA SIMPLE PARA DESBROZADORA SIMPLE GRIP FOR BRUSH CUTTER

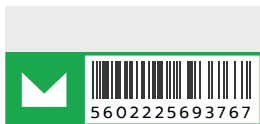

Para Modelo / Para El Modelo / For Model	<b>69260</b>
	<b>69261</b>
	<b>69297</b>
	<b>49255</b>

N. Ref.	Descrição	Marca	Quant. Caixa
69376	GUIADOR PEGA SIMPL P/ROÇAD	MADER GARDEN TOOLS	33

## PUNHO COM ACELERADOR MANGO ACELERADOR ACCELERATOR HANDLE



## UNIVERSAL

Ø 19 mm

Para Modelo / Para El Modelo

69260, 69261, 69297, 49255,  
69295, 69350, 69600

para Roçadora Multifunções  
para Desbrozadora Multifunciones  
for Multifunction Brush Cutter



para Roçadora  
para Desbrozadora  
for Brush Cutter

N. Ref.	Descrição	Marca	Quant. Caixa
69264	PUNHO C/ACELERADOR P/ROÇADOURA	MADER GARDEN TOOLS	21
69327	CABO ACELERADOR P/ROÇAD COSTA	MADER GARDEN TOOLS	27
69269	PUNHO C/ACELERAD P/ROÇAD MULTI	MADER GARDEN TOOLS	1

## RESGUARDO PARA ROÇADORA FUNDA PARA DESBROZADORA GUARD FOR MOWING

Universal



26/28mm



## ABRAÇADEIRA ABRAZADERA CLAMP

para Resguardo  
de Resguardo



Ø 26 / 28 mm



Ø 28 mm

N. Ref.	Descrição	Marca	Quant. Caixa
69229	RESGUARDO P/ROÇADOURA 26/28MM	MADER GARDEN TOOLS	25
03735	ABRAÇ P/RESGUARD ROÇ 26MM-28MM	MADER	20
03736	ABRAÇ P/RESGUARD ROÇ 28MM	MADER	20/20



**GUIADOR / BRAÇO » ROÇADORA**  
**MANILLAR » DESBROZADORA**  
**BIKE TYPE HANDLE » BRUSH CUTTER**

**Duplo**  
**UNIVERSAL**



**ACELERADOR REFORÇADO**  
**ACCELERATOR REFORCED**



Descrição: Guiador p/ Roçadora

Marca: Mader Garden

N. Ref.	Especificação	Quant.	Caixa:
69263	Braço Dulpo	20	
69375	Braço Dulpo - Reforçado	12	

**ABRAÇADEIRA » ROÇADORA**  
**ABRAZADERA » DESBROZADORA**  
**CLAMP » BRUSH CUTTER**

**DIRECIONAL**  
**DIRECCIONAL**  
**DIRECTIONAL**



**SUPORE**  
**SOPORTE**  
**HANDLE FIXER**

**REFORÇADO**  
**REFORZADO**  
**REFORCED**



Descrição: União / Abraçadeira

Marca: Mader Garden

N. Ref.	Especificação	Quant.	Caixa:
69240	do Guiador ao Tubo (φ 28mm)	20	
69370	Suporte Reforçado (φ 28mm)	1	



**ABRAÇADEIRA » ROÇADORA**  
**ABRAZADERA » DESBROZADORA**  
**CLAMP » BRUSH CUTTER**

p/ | to 69261



Descrição: União / Abraçadeira

Marca: Mader Garden

N. Ref.	Especificação	Quant.	Caixa:
69234	p/ Roçadora de Mochila	20	
69262	Parafuso de Fixação - 5 un.	5	



**PARAFUSO DE FIXAÇÃO**  
**TORNILLO**  
**BOLT**



**5un**



**TAMPA P/ DEPÓSITO**  
**TAPÓN P/ TANQUE**  
**FUEL TANK CAP**



Descrição: Acessórios p/ Roçadora

Marca: Mader Garden

N. Ref.	Especificação	Quant.	Caixa:
69238	Tampa p/ Depósito	100	
69239	Filtro de Gasolina	50	



**FILTRO DE GASOLINA**  
**GASOLINE FILTER**



## BOBINE PARA ROÇADORA BOBINA PARA DESBROZADORA TRIMMER HEAD FOR BRUSH CUTER

**Metal**

**UNIVERSAL**



**PARAFUSO LATERAL  
TORNILLO LATERAL  
SIDE SCREW**

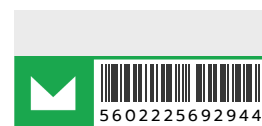

<b>Furos / Agujeros / Holes</b>	<b>8x</b>	<b>4x</b>	<b>4x</b>
<b>Fio / Hilo / Wire</b>	<b>4x 3mm</b>	<b>2x 3mm</b>	<b>2x 3mm</b>

N. Ref.	Descrição	Marca	Quant. Caixa
69277	BOBINE FIO-MGD-P/ROÇ 8XMET3MM	MADER GARDEN TOOLS	50
69278	BOBINE FIO-MGD-P/ROÇ 4XMET3MM	MADER GARDEN TOOLS	50
69294	BOBINE FIO-MGD-P/ROÇ 4X	MADER GARDEN TOOLS	50

## BOBINE PARA ROÇADORA BOBINA PARA DESBROZADORA TRIMMER HEAD FOR BRUSH CUTER

**Alumínio  
Aluminium**

**UNIVERSAL**

**sem Fio  
sin Hilo  
wireless**

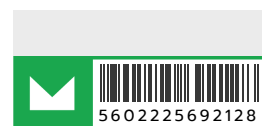
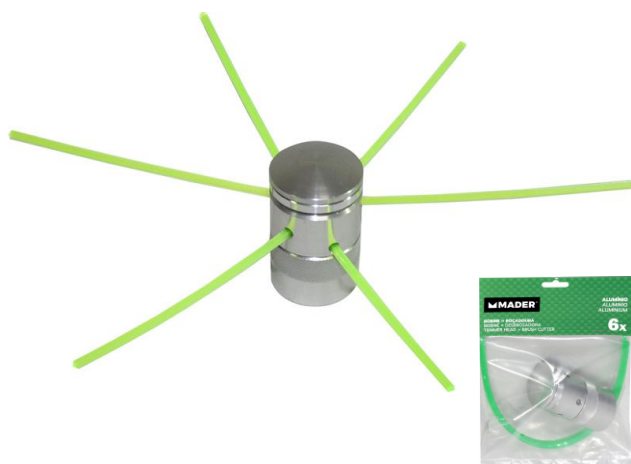

<b>Furos / Agujeros / Holes</b>	<b>8x</b>	<b>6x</b>
<b>Fio / Hilo / Wire</b>	<b>4x 3mm</b>	<b>3x 3mm</b>

N. Ref.	Descrição	Marca	Quant. Caixa
48061	BOBINE FIO-MGD-P/ROÇAD ALUM	MADER GARDEN TOOLS	50
69212	CABEÇA FIO P/ROÇ-MGD-6 FUROS	MADER GARDEN TOOLS	25

## BOBINE PARA ROÇADORA BOBINA PARA DESBROZADORA TRIMMER HEAD FOR BRUSH CUTER

Plástico  
Plastic



48069

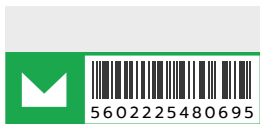

5602225480695

Recom. » Ref.: 49269

M8 x 1.25F

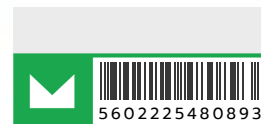

5602225480893

**ROSCA DIREITA**  
**ROSCA DERECHA**  
**RIGHT THREAD**

Furos / Agujeros / Holes	2x
Fio / Hilo / Wire	2.4 mm

### AUTOMÁTICA



69279



5602225692791

UNIVERSAL

M10 x 1.25F



Furos / Agujeros / Holes	2x
Fio / Hilo / Wire	2.4 mm

### AUTOMÁTICA



48085

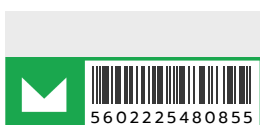

5602225480855

UNIVERSAL

M10 x 1.25F



Furos / Agujeros / Holes	2x
Fio / Hilo / Wire	2.4 mm



48063

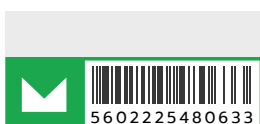

5602225480633

UNIVERSAL

M10 x 1.25F



Furos / Agujeros / Holes	2x
Fio / Hilo / Wire	2.4 mm

### AUTOMÁTICA



48086



5602225480862

UNIVERSAL

M10 x 1.25F



**RECARGA RÁPIDA**  
**FAST LOAD**



Furos / Agujeros / Holes	2x
Fio / Hilo / Wire	2.4 mm

N. Ref.	Marca	Quant. Caixa
48069	BOBINE FIO-MGD-P/ROÇ M8X1.25F	50
48089	BOBINE FIO-MGD-M8X1.25F R/DTA	50/12
69279	BOBINE FIO-MGD-P/ROÇ NYL2,4MM M10	15
48085	BOB FIO NYL-MGD-M10X1.25F AUTO	50
48063	BOBINE FIO-MGD-P/ROÇ M10X1.25F BOB	50
48086	FIO NY-MGD-M10X1.25F FACIL	40
48087	BOB FIO NYL-MGD-M8X1.25F 69612	1/1

**2 mm**  
**M8 x 1.25F**

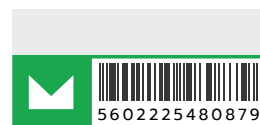

5602225480879

**CABEÇA » ROÇADORA**  
**CABEZA » DESBROZADORA**  
**GEAR BOX » BRUSH CUTTER**

**UNIVERSAL**



**7D 26 mm**

Descrição: Cabeça p/ Roçadora		
Marca: Mader Garden		
N. Ref.	Especificação	Quant. Caixa:
69225	26 mm - 7D	10
69226	26 mm - 9D	30
69230	28 mm - 9D	30



**9D 26 mm**



**9D 28 mm**

**ACESSÓRIOS P/ FIXAR O DISCO » ROÇADORA**  
**ACCESORIOS DE FIJACIÓN DE DISCO » DESBROZADORA**  
**DISC FIXING ACCESSORIES » BRUSH CUTTER**

**PORCA » CABEÇA**  
**TUERCA » CABEZA**  
**NUT » HEAD**



**TAÇA/COPO PROTEÇÃO PARA DISCO**  
**COPA/DISCO PROTECTOR DE COPA**  
**BOWL/CUP FOR DISC PROTECTION**

Descrição: Acessórios p/ Fixar Disco » Roçadora		
Marca: Mader Garden		
N. Ref.	Especificação	Quant. Caixa:
03438	Taça/Copo Proteção Disco	1
65991	Porca para Cabeça - 2un.	2
03428	Anilhas de Fixar o Disco - 6D	1
03427	Anilhas de Fixar o Disco - 10D	1



**2UN**



**6D** p/ Mader Garden

**ANILHAS DE FIXAR » DISCO**  
**ANILLOS DE FIJACIÓN » DISCO**  
**DISC » FIXING WASHERS**



**10D** p/ Mac Power

**DISCO HEXAGONAL ANTI-ERVA**  
**FUNDA ANTI ENREDOS**  
**ANTI-TANGLE COVER**

**ROÇADORA**  
**DESBROZADORA**  
**BRUSH CUTTER**

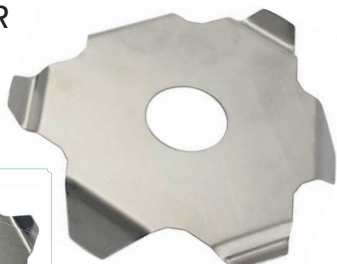

**DISCO PARA ROÇADORA**  
**DISCO PARA DESBROZADORA**  
**DISC FOR BRUSH CUTTER**

**PROTEÇÃO DE RAMOS E ARBUSTOS**  
**PROTECCIÓN DE RAMAS Y**  
**ARBUSTOS BRANCH AND BUSH**  
**PROTECTION**



Descrição: Disco p/ Roçadora		
Marca: Mader Garden		
N. Ref.	Especificação	Quant. Caixa:
48044	Hexagonal - Anti-Erva - 25,4mm	50
48015	Disco P/Roç-MGD- C/Prot	50



**φ 25,4mm**



**2un**

**DISCO » ROÇADORA**  
**DISCO » DESBROZADORA**  
**CUTTING BLADE » BRUSH CUTTER**

## UNIVERSAL

**PLANO**  
**LLANO**  
**FLAT**



**2D**  
**300 mm**



φ 25,4 mm x 2,4 mm  
 48052 BL



**CURVO**  
**CURVED**



φ 25,4 mm x 3,0 mm  
 48029 Caixa Cartão



**DENTADO**  
**INDENTED**



φ 25,4 mm x 3,0 mm  
 D-BL 48045

**PLANO**  
**LLANO**  
**FLAT**



**3D**  
**255 mm**



φ 25,4 mm x 1,4 mm  
 48036 D-BL

**PLANO**  
**LLANO**  
**FLAT**



φ 25,4 mm x 3,0 mm  
 48035 D-BL



**CURVO**  
**CURVED**



φ 25,4 mm x 3,0 mm  
 Caixa Cartão 48055



**8D**  
**255 mm**



φ 25,4 mm x 2,4 mm  
 48053 D BL

**PLANO**  
**LLANO**  
**FLAT**

Descrição: Disco p/ Roçadora

Marca: Mader Garden

N. Ref.	Especificação	Quant. Caixa:
48052	300 x 2,4mm x 2D - Plano	25
48029	300 x 3,0mm x 2D - Curvo	25
48045	300 x 3,0mm x 2D - Cur/Dentado	25
48036	255 x 1,4mm x 3D - Plano	25
48055	300 x 3,0mm x 3D - Curvo	20
48035	300 x 3,0mm x 3D - Plano	25
48053	255 x 2,4mm x 8D - Plano	25

## DISCO PASTILHADO DISCO PASTILLADO TIPPED CUTTING BLADE

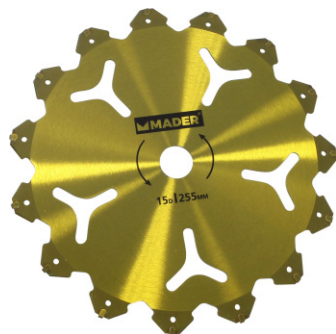

Ø 255 mm



**Dentes duplos**  
Dientes dobles  
Double teeth

15 D

20 D



40 D

**UNIVERSAL**

**ROÇADORA**  
DESBRUZADORA  
BRUSH CUTTER



Dentes / Dientes / Teeth	15	20	40
Disco (Furo) / Disco (Agujero) / Disc (Hole)	Ø 25.4 mm	Ø 25.4 mm	Ø 25.4 mm
Espessura / Espesor / Thickness	1.4 mm	2 mm	3 mm

N. Ref.	Descrição	Marca	Quant. Caixa
48051	DISCO P/ROÇ-MGD-255X15DENTES	MADER GARDEN TOOLS	25
48054	DISCO P/ROÇ-MGD-255X20DENTES	MADER GARDEN TOOLS	25
48046	DISCO P/ROÇ-MGD-255X40D PAST	MADER GARDEN TOOLS	25



## CATRABUCHA CEPILLO WIRE BRUSH

**ROÇADORA**  
DESBRUZADORA  
BRUSH CUTTER

**Limpeza de Passeios**  
Limpieza de Paseos  
Sidewalk Cleaning



Ø 150 mm



Ø 200 mm



Disco (Furo) / Disco (Agujero) / Disc (Hole)	Ø 25.4 mm	Ø 25.4 mm
Espessura / Espesor / Thickness	30 mm	50 mm
Velocidade / Velocidad / Speed	10 000 rpm (max)	10 000 rpm (max)

N. Ref.	Descrição	Marca	Quant. Caixa
48041	CATRAB-MGD-LIMP PASSEIO P/ROÇ	MADER POWER TOOLS	20
48040	CATRAB-MGD-LIMP PASSEIO P/ROÇ	MADER GARDEN TOOLS	10

### FIO DE NYLON HILO NYLON NYLON WIRE



**REDONDO**  
**REDONDO**  
**ROUND**

**MATÉRIA PRIMA - VIRGEM**  
**MATERIA PRIMA - VIRGEN**  
**RAW MATERIAL - VIRGIN**



15 m **1,3mm**



15 m **1,6mm**



15 m **2,0mm**



41 m **2,4mm**



84 m **2,4mm**



26 m **3,0mm**



54 m **3,0mm**



22 m **3,3mm**



44 m **3,3mm**

Descrição: Fio de Nylon - Redondo

Marca: Mader Garden

N. Ref. Especificação

Quant. Caixa:

90401	1,3 mm - 15m	16/192
90402	1,6 mm - 15m	16/192
90403	2,0 mm - 15m	10/120
90404	2,4 mm - 41m	10/40
90405	2,4 mm - 84m	10/20
90406	3,0 mm - 26m	10/40
90407	3,0 mm - 54m	10/20
90408	3,3 mm - 22m	10/40
90409	3,3 mm - 44m	10/20

#### Rolo

90445	2,4 mm - 384m - 2Kg	1/4
90446	3,0 mm - 246m - 2Kg	1/4
90390	3,0 mm - 280m	1/4
90393	3,3 mm - 205m	1/4

**ROLO**



**2Kg**



384 m **2,4mm**



246 m **3,0mm**

**2Kg**



280 m **3,0mm**



205 m **3,3mm**

### FIO DE NYLON HILO NYLON NYLON WIRE

**MATÉRIA PRIMA - VIRGEM**  
**MATERIA PRIMA - VIRGEN**  
**RAW MATERIAL - VIRGIN**



**ESTRELA**  
**ESTRELLA**  
**STAR SHAPE**



Descrição: Fio de Nylon - Estrela

Marca: Mader Garden

N. Ref. Especificação

Quant. Caixa:

90410	2,4 mm - 92 m	10/20
90411	3,0 mm - 60 m	10/20
90412	3,3 mm - 49 m	10/20



92 m **2,4mm**



60 m **3,0mm**



49 m **3,3mm**

### FIO DE NYLON

HILO NYLON  
NYLON WIRE

**MATÉRIA PRIMA - VIRGEM**  
MATERIA PRIMA - VIRGEN  
RAW MATERIAL - VIRGIN



### QUADRADO CUADRADO SQUARE



400 mm



50 un **3,3mm**



50 un **4,0mm**



15 m **2,0mm**



15 m **2,4mm**



25 m **2,4mm**



15 m **3,0mm**



25 m **3,0mm**



29 m **4,0mm**



144 m **4,0mm**



300 m **4,0mm**



144 m **4,0mm**



300 m **4,0mm**



144 m **4,0mm**



300 m **4,0mm**



15 m **2,0mm**



15 m **2,4mm**



15 m **3,0mm**



Descrição: Fio de Nylon - Quadrado

Marca: Mader Garden

N. Ref.	Especificação	Quant. Caixa:
90434	3,3mm x 400mm - 50un	1/50
90419	4,0mm x 400mm - 50un	1/50
90413	2,0mm - 15m	12/120
90414	2,4mm - 15m	10/40
90416	2,4mm - 25m	10/80
90415	3,0mm - 15m	10/80
90417	3,0mm - 25m	10/40
90418	4,0mm - 29m	10/20

#### Rolo

90391	4,0mm - 144m	1/4
90392	4,0mm - 300m	2/4



### FIO DE NYLON

HILO NYLON  
NYLON WIRE

**MATÉRIA PRIMA - VIRGEM**  
MATERIA PRIMA - VIRGEN  
RAW MATERIAL - VIRGIN



### TORCIDO TRENZADO TWIST



15 m **1,6mm**

Descrição: Fio de Nylon - Torcido

Marca: Mader Garden

N. Ref.	Especificação	Quant. Caixa:
90430	1,6 mm - 15m	10/120
90431	2,0 mm - 15m	10/120
90432	2,4 mm - 15m	10/80
90433	3,0 mm - 15m	10/80



15 m **2,0mm**



15 m **2,4mm**



15 m **3,0mm**

### FIO DE NYLON

HILO NYLON  
NYLON WIRE

MATÉRIA PRIMA - VIRGEM  
MATERIA PRIMA - VIRGEN  
RAW MATERIAL - VIRGIN



24 un **3,0mm**

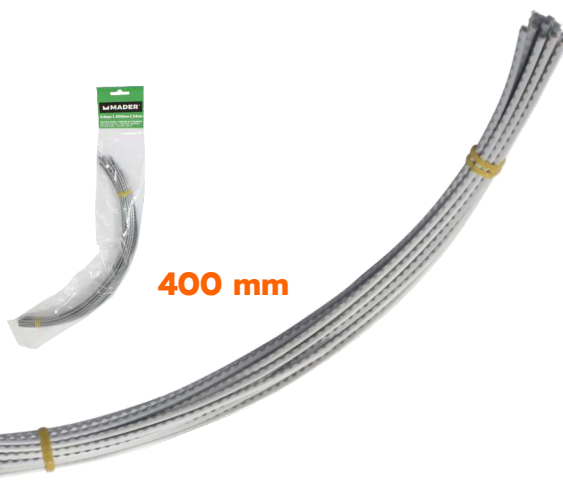

**400 mm**

### DENTES TUBARÃO

DIENTES TIBURÓN  
SHARK TEETH

Descrição: Fio de Nylon - Dentes Tubarão

Marca: Mader Garden

N. Ref.	Especificação	Quant. Caixa:
90438	3,0 x 400 mm - 24 un	10/200
90439	3,0 mm - 30 m	10/40



30 m **3,0mm**

### FIO DE NYLON

HILO NYLON  
NYLON WIRE



37 m **4,0mm**



29 m **4,5mm**



### ESPIRAL / SILENCIOSO

ESPIRAL / SILENCIOSO  
SPIRAL / SILENT

Descrição: Fio de Nylon - Espiral / Silencioso

Marca: Mader Garden

N. Ref.	Especificação	Quant. Caixa:
90441	4,0 mm - 37m	10
90443	4,0 mm - 163m	4
90442	4,5 mm - 29m	10
90444	4,5 mm - 128m	4



163 m **4,0mm**



128 m **4,5mm**



**VAREJADOR DE AZEITONAS**  
VAREADOR DE OLIVAS  
OLIVE SHAKER

**HASTE EXTENSÍVEL**  
VARILLA EXTENSIBLE  
EXTENSIBLE HANDLE

**1.5 » 2.5 m**

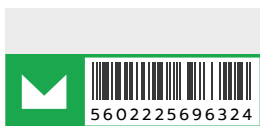

**12 V DC**  
130W

**Bateria » 20 Ah / 12 V**  
(não incluída) (no incluido) (not included)

Cabo / Cable	11 m		
Ruído / Noise	94 db(A)		
N. Ref.	Descrição	Marca	Quant. Caixa
69632	VAREJADOR AZEITON-MGD-12V 130W	MADER GARDEN TOOLS	1/1

**VAREJADOR DE AZEITONAS**  
VAREADOR DE OLIVAS  
OLIVE SHAKER

**HASTE EXTENSÍVEL**  
VARILLA EXTENSIBLE  
EXTENSIBLE HANDLE

**2.32 » 3.15 m**

**3 VELOCIDADES**  
3 SPEEDS

**BRUSHLESS**

**BATERIA**  
BATERÍA  
BATTERY



**Bateria: 20/ 40/ 60Ah - 12V**  
(não incluída) (no incluido) (not included)

**SÓ ADMITE BATERIAS DE 12V**  
SÓLO ACEPTA BATERÍAS DE 12V  
ONLY ACCEPTS 12V BATTERIES



**12V DC**  
340 W

Velocidade / Velocidad / Speed	1100 / 1250 / 1400 BPM		
Peso / Weight	2.7Kg		
Ruído / Noise	102db(A)		
N. Ref.	Descrição	Marca	Quant. Caixa
69633	VAREJADOR AZEITON-MGD-12V 340W	MADER GARDEN TOOLS	1/1

## CABO BATERIA CABLE BATERÍA BATTERY CABLE



49293



5602225492933

12M

Para Modelo / Para El Modelo / For Model

REF. 69633

N. Ref.	Descrição	Marca	Quant. Caixa
49293	CABO P/BATERIA-MGD-P/VAREJ 12M	MADER GARDEN TOOLS	100/1

## ACESSÓRIOS » VAREJADOR ACCESORIOS » VAREADOR ACCESSORIES » SHAKER

Para / For: 69633



5602225492940

10UN

2UN

2UN

### VARETA VARILLA | RODS

N. Ref.	Descrição	Marca	Quant. Caixa
49294	VARETAS-MGD-P/VAREJADOR 10UN	MADER GARDEN TOOLS	100/1
49295	SUPOORTE VARETA-MGD-P/VAREJ 2UN	MADER GARDEN TOOLS	100/1
49296	ENCAIXE VARETA-MGD-P/VAREJ 2UN	MADER GARDEN TOOLS	100/1



5602225492957

**SUPOORTE P/ VARETAS**  
SOPORTE PARA VARILLAS  
HOLDER FOR RODS



5602225492964

**ENCAIXE P/ VARETAS**  
ENCAJE PARA VARILLAS  
GROOVE FOR RODS

## ACESSÓRIOS » VAREJADOR ACCESORIOS » VAREADOR ACCESSORIES » SHAKER

2 un



56022251080000

p/ ref.  
49264

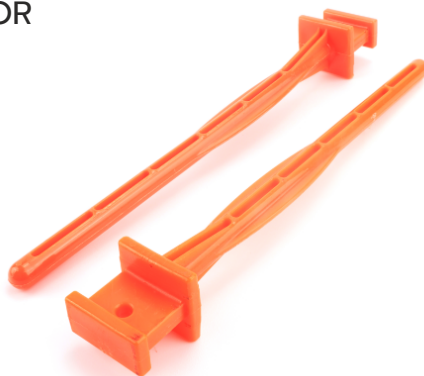

p/ ref.  
49264



56022251080017

### VARETA » PENTE VARA » RASTRILLO ROD » RAKE

1 un

**CONETOR**  
CONECTOR  
CONNECTOR

Descrição: Acessórios p/ Varejador		
Marca: Mader Garden		
N. Ref.	Especificação	Quant. Caixa:
08000	Vareta (Pente) » 49264 - 1 un	20
08001	Conector » 49264 - 2 un	20

## BATERIA BATERÍA BATTERY

≈ 4h (depende da intensidade)  
≈ 4h (depende de la intensidad)  
≈ 4h (depends on intensity)

para / to  
Ref.:69633

## MOCHILA BACKPACK



**Taxa de descarga: 5C**  
Índice de descarga: 5C  
Discharge rate: 5C

**Carregador ref. 69653**  
Cargador ref. 69653  
Charger ref. 69653



**16 Ah**  
**12 V**

**AVISO!**  
Utilize um carregador adequado a baterias de lítio.  
Armazene a bateria num local fresco e seco.  
Não aqueça nem coloque a bateria no fogo.  
Nunca desmonte a bateria.

**ADVERTENCIA!**  
Utilice un cargador adecuado para baterías de litio.  
Guarde la batería en un lugar fresco y seco.  
No caliente ni ponga la batería en el fuego.  
No desmonte nunca la batería.

**Cabo / Cable** **15 m**

N. Ref.	Descrição	Marca	Quant. Caixa
69651	BATERIA-MGD-12V 16AH MOCHILA	MADER GARDEN TOOLS	1/1

## CARREGADOR PARA BATERIA CARGADOR DE BATERÍA BATTERY CHARGER

**Recom. Bat.**  
**Ref. 69651**



**DC 12 V - 3 A**

**Tensão / Tensión / Voltage** **230V~ 50Hz**

N. Ref.	Descrição	Marca	Quant. Caixa
69653	CARREGADOR-MGD-12V 3A P/69651	MADER GARDEN TOOLS	1/1



## BATERIA BATERÍA BATTERY

Taxa de descarga: 5C  
Índice de descarga: 5C  
Discharge rate: 5C



para / to  
Ref.:69633



**12 V**  
**8 Ah**

≈ 2h (depende da intensidade)  
≈ 2h (depende de la intensidad)  
≈ 2h (depends on intensity)

N. Ref.	Descrição	Marca	Quant. Caixa
69650	BATERIA-MGD-12V 8AH	MADER GARDEN TOOLS	1/1

## CARREGADOR PARA BATERIA CARGADOR DE BATERÍA BATTERY CHARGER



**DC 12 V - 2 A**

Tensão / Tensión / Voltage **230V- 50Hz**

N. Ref.	Descrição	Marca	Quant. Caixa
69652	CARREGADOR-MGD-12V 2A P/69650	MADER GARDEN TOOLS	1/1

Recom. Bat.  
Ref. 69650

## ADAPTADOR PARA BATERIA ADAPTADOR PARA BATERÍA ADAPTER FOR BATTERY



**1.5m**



**2x2.0mm<sup>2</sup>**  
**339g**

N. Ref.	Descrição	Marca	Quant. Caixa
69662	ADAPTAD P/BAT-MGD-150CM 2X2MM2	MADER GARDEN TOOLS	1/1

### CINTO PARA BATERIA CINTURÓN PARA BATERÍA BELT FOR BATTERY



**890 mm**

<b>Espessura / Espesor / Thickness</b>	<b>15.5 mm</b>
<b>Peso / Weight</b>	<b>245 g</b>

N. Ref.	Descrição	Marca	Quant. Caixa
69660	CINTO P/BATERIA-MGD-89CCM	MADER GARDEN TOOLS	1/1

### BOLSA PARA BATERIA BOLSA PARA BATERÍA BAG FOR BATTERY



**2 UN**

<b>Medidas / Measures</b>	<b>110 x 110 x 110 mm</b>
<b>Peso / Weight</b>	<b>79.5 g</b>

N. Ref.	Descrição	Marca	Quant. Caixa
69661	BOLSA P/BATE-MGD-11CMX11CM 2UN	MADER GARDEN TOOLS	1/1

**Cinto 69660 não incluído**  
Cinturón 69660 no incluido  
Belt 69660 not included

## VAREJADOR DE AZEITONAS VAREADOR DE OLIVAS OLIVE SHAKER



**25,4cc**  
φ 26 mm



KM0406260F

**2** Transmissões  
Transmisiones  
Shaft

φ 8 mm » Veio/Eixo /Eje /Axis  
◇ 5 mm » Encaixe /Encaje /Slot



**2,3 m**

**Suspensório**  
Tirante  
Suspend

**Potência** /Potencia/Power:

**Refrigerado a Ar** /Refrigerado al Aire

**Tubo** /Working Pole : φ x Comp. /Length

**Pega** /Manija /Handle:

**Transmissão** /Transmisión /Shaft:

**Arranque** /Arranque /Start:

**Ruído** /Noise:

**Dimensões** /Dimensiones/Size:

**Peso** /Weight:

Explosão - 2T

25,4 cc - 0,70 KW

7500 r.p.m.

Sim /Si /Yes

26mm x 2,3m

Simple /Simple /Single

2

Manual

102 db(A)

1100 x 260 x 230 mm

8,5 Kg

**GASOLINA C/ MISTURA**  
GASOLINA MEZCLADA  
GASOLINE WITH OIL **4%**

Óleo/Aceite/Oil » 2T  
(não incluído /no incluido /not included)  
Recomendamos (25208)



**2T** Monocilindrico  
Single Cylinder

Descrição: Varejador de Azeitona

Marca: Mader Garden

N. Ref. Especificação

49246 Gasolina - 25,4 cc

Quant. Caixa:

1

**ACESSÓRIOS » VAREJADOR**  
**ACCESORIOS » VAREADOR**  
**ACCESSORIES » SHAKER**

**ENCAIXE » VARETA**  
**ENCAJE » VARILLA**  
**SLOT » ROD**

2un



S/Rosca /W/Thread

2un



C/Rosca /W/Thread

2un



C/Rosca /W/Thread  
 p/ ref. **49246**

**SUPORE » VARETA**  
**SOPORTE » VARILLA**  
**SUPPORT » ROD**



S/Rosca /W/Thread



C/Rosca /W/Thread

**VARETA**  
**VARILLA**  
**ROD**

10un

C/Rosca /W/Thread



10un

C/Rosca /W/Thread



p/ ref. **49246**



p/ ref. **49274**

**ENCAIXE**



10un  
 S/Rosca | S/Rosca | W/Thread



p/ ref. **49274 (ANTIGO)**

Descrição:	Acessórios p/ Varejador	
Marca:	Mader Garden	
N. Ref.	Especificação	Quant. Caixa:
49289	Encaixe » Vareta s/ Rosca	1
49290	Encaixe » Vareta c/ Rosca	1
49297	Encaixe » Var c/ R. p/49246	1
49288	Suporte » Vareta s/ Rosca	1
49287	Suporte » Vareta c/ Rosca	1
49298	Vareta c/ Rosca - 10 un	1
49285	Vareta c/ Rosca - 10 un	1
49286	Vareta s/ Rosca - 10 un	1



## UISEIRA DE PROTEÇÃO PROTECTOR FACIAL MESH FACE SHIELD

**ACRÍLICO**  
ACRILICO  
ACRYLIC



**Amarelo**  
Amarillo  
Yellow



**Amarelo**  
Amarillo  
Yellow

**Polybag**



**Laranja**  
Naranja  
Orange

**Polybag**

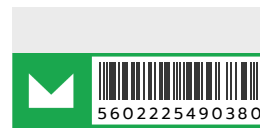

N. Ref.	Descrição	Marca	Quant. Caixa
65211	UISEIRA PROTEC-MHW-ACRILICO	MADER HARDWARE	40/10
57677	UISEIRA PROTEC-MHW-PL FS8051	MADER HARDWARE	24/24
49038	UISEIRA-MGD-KM1504019-P HDCARD	MADER GARDEN TOOLS	20/20

## UISEIRA DE PROTEÇÃO PROTECTOR FACIAL MESH FACE SHIELD

**REDE METÁLICA**  
RED METALICA  
STEEL MESH



**Amarelo**  
Amarillo  
Yellow



**Laranja**  
Naranja  
Orange



**Avulso**



**Avulso**

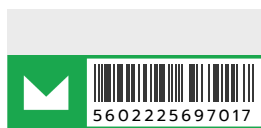

**Polybag**

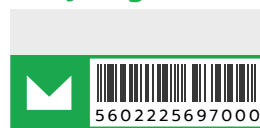

N. Ref.	Descrição	Marca	Quant. Caixa
65210	UISEIRA PROTEC-MHW-REDE	MADER HARDWARE	40/10
69701	UISEIRA-MGD-C/REDE LARANJA AVUL	MADER GARDEN TOOLS	40/1
69700	UISEIRA-MGD-C/REDE LARANJA	MADER GARDEN TOOLS	20/1

**ACESSÓRIOS » VISEIRA PROTECÇÃO**  
**ACCESORIOS » PROTECTOR FACIAL**  
**ACCESSORIES » FACE SHIELD**

Compatível { 65211  
 Compatible { 65210  
 Compatible



65211



65210



**ACRÍLICO**  
**ACRILICO**  
**ACRYLIC**



**REDE METÁLICA**  
**RED METALICA**  
**STEEL MESH**



SUPORE CABEÇA NÃO INCLUÍDO  
 SOPORTE PARA LA CABEZA NO INCLUIDO  
 HEAD SUPPORT NOT INCLUDED

Descrição: Acessórios » Viseira Protecção

Marca: Mader Hardware

N. Ref.	Especificação	Quant. Caixa
65213	Acrílico - p/ 65211	10
65214	Rede Metálica - p/ 65210	10

**KIT PROTECÇÃO**  
**JUEGO PROTECCIÓN**  
**PROTECTION KIT**

**Capacete**  
**Viseira**  
**Auscultadores**

**Casco**  
**Protector Facial**  
**Auriculares**

**Helmet**  
**Mesh Face Shield**  
**Headphones**



49040

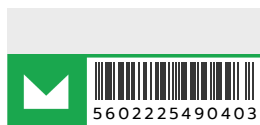

5602225490403

**Metal**



N. Ref.	Descrição	Marca	Quant. Caixa
49040	CAPACETE+VISEIRA+AUSC-MGD-3PC	MADER GARDEN TOOLS	8



**ÓCULOS DE PROTEÇÃO**  
GAFAS DE PROTECCIÓN  
SAFETY GLASSES



**Lente de rede**  
Lente de red  
Mesh Lens

**Armação Preta**  
Armadura Negra  
Black Frame

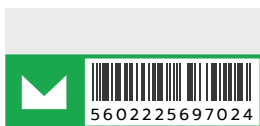

N. Ref.	Descrição	Marca	Quant. Caixa
69702	ÓCULOS PROTEÇÃO-MGD-REDE	MADER GARDEN TOOLS	1/1

## CANELEIRAS DE PROTEÇÃO CANILLERAS DE PROTECCIÓN LEG PROTECTIONS



48230



5602225482309

**1 Par**

para ROÇADORA  
para DESBROZADORA  
for BRUSH CUTTER

N. Ref.	Descrição	Marca	Quant. Caixa
48230	CANELEIRAS PROT-MGD-P/ROÇ PAR	MADER GARDEN TOOLS	25

## AVENTAL DE PROTEÇÃO FALDÓN DE PROTECCIÓN SAFETY APRON



**POLYESTER**



49030



5602225490304

**70 x 180 cm**

## CALÇAS PROTEÇÃO PANTALONES DE PROTECCIÓN SAFETY TROUSERS



48239

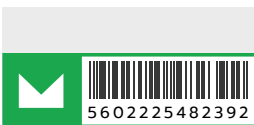

5602225482392

para ROÇADORA e MOTOSSERRA  
para DESBROZADORA y MOTOSIERRA  
for BRUSH CUTTER and CHAIN SAW

N. Ref.	Descrição	Marca	Quant. Caixa
49030	AVENTAL-MGD-P/ROÇADOURA	MADER GARDEN TOOLS	40
48239	CALÇAS PROT-MGD-P/ROÇADOURA	MADER GARDEN TOOLS	25

## SUSPENSÓRIO DUPLO SUSPENSIONE DOBLE DOUBLE SUSPENDER

PARA ROÇADORA MOCHILA  
PARA DESBROZADORA CON MOCHILA  
FOR BRUSH CUTTER WIT BAG PACK

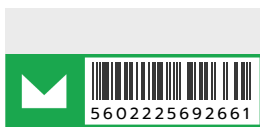

Para Modelo / Para El Modelo / For Model **69260, 69261**

N. Ref.	Descrição	Marca	Quant. Caixa
69266	SUSPENSÓRIO P/ROÇADOURA MOCHIL	MADER GARDEN TOOLS	10/10

## ESTRUTURA METÁLICA ESTRUCTURA METÁLICA METALLIC STRUCTURE

PARA ROÇADORA COM MOCHILA  
PARA DESBROZADORA CON MOCHILA  
FOR BRUSH CUTTER WITH BAG PACK



Para Modelo / Para El Modelo / For Model **69260 - 69261**

N. Ref.	Descrição	Marca	Quant. Caixa
69268	ESTRUTURA METÁLICA P/ROÇADOURA	MADER GARDEN TOOLS	6/6

## SUSPENSÓRIO PARA ROÇADORA ARNES PARA DESBROZADORA SUSPENDERS FOR BRUSH CUTTER

# UNIVERSAL

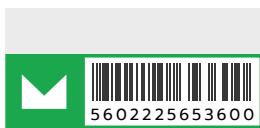

N. Ref.	Descrição	Marca	Quant. Caixa
65360	SUSPENSÓRIO-MHW-SIMPLES	MADER HARDWARE	50/50

**SIMPLES**  
SIMPLE

**SUSPENSÓRIO PARA ROÇADORA**  
**ARNES PARA DESBROZADORA**  
**SUSPENDERS FOR BRUSH CUTTER**

**UNIVERSAL**



**ARNÊS SIMPLES**  
**ARNÉS SIMPLE**  
**SIMPLE HARNESS**

N. Ref.	Descrição	Marca	Quant. Caixa
65362	SUSPENSÓRIO-MHW-KM520	MADER HARDWARE	6/30

**SUSPENSÓRIO PARA ROÇADORA**  
**ARNES PARA DESBROZADORA**  
**SUSPENDERS FOR BRUSH CUTTER**

**UNIVERSAL**

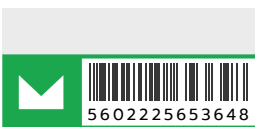

**ARNÊS DUPLO**  
**ARNÉS DOBLE**  
**DOUBLE HARNESS**

N. Ref.	Descrição	Marca	Quant. Caixa
65364	SUSPENSÓRIO-MGD-DUPLO	MADER GARDEN TOOLS	50/50

**SUSPENSÓRIO PARA ROÇADORA**  
**ARNES PARA DESBROZADORA**  
**SUSPENDERS FOR BRUSH CUTTER**

**UNIVERSAL**



**ARNÊS DUPLO**  
**ARNÉS DOBLE**  
**DOUBLE HARNESS**

N. Ref.	Descrição	Marca	Quant. Caixa
65363	SUSPENSÓRIO-MHW-DUPLO KM882	MADER HARDWARE	20/20

## SUSPENSÓRIO PARA ROÇADORA ARNES PARA DESBROZADORA SUSPENDERS FOR BRUSH CUTTER

CONFORTO  
COMODIDAD  
COMFORT

UNIVERSAL



65361

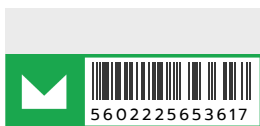

5602225653617

N. Ref.	Descrição	Marca	Quant. Caixa
65361	SUSPENSÓRIO-MHW-DUPLO	MADER HARDWARE	20/20

ARNÊS DUPLO  
ARNÉS DOBLE  
DOUBLE HARNESS

## SUSPENSÓRIO PARA ROÇADORA ARNES PARA DESBROZADORA SUSPENDERS FOR BRUSH CUTTER

CONFORTO  
COMODIDAD  
COMFORT

UNIVERSAL

ARNÊS DUPLO  
ARNÉS DOBLE  
DOUBLE HARNESS



69710



5602225697109

N. Ref.	Descrição	Marca	Quant. Caixa
69710	SUSPENSÓRIO-MGD-DUPLO	MADER GARDEN TOOLS	1/20



**CORTA-SEBES**  
CORTASETOS  
HEDGE TRIMMER



**600 W**  
**550 mm**



**com Proteção da Lâmina**  
con Protección de la Espada  
with Blade Protection

<b>RPM</b>	<b>1700</b>
<b>Tensão / Tensión / Voltage</b>	<b>230V-50Hz</b>

N. Ref.	Descrição	Marca	Quant. Caixa
49253	CORTA SEBES-MGD-600W 550MM	MADER GARDEN TOOLS	4

**PODADORA SEBES**  
PODADORA SETOS  
HEDGE TRIMMER



**PUNHO ROTATIVO - 2 POSIÇÕES**  
MANGO GIRATORIO - 2 POSICIONES  
ROTATING HANDLE - 2 POSITIONS

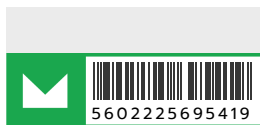

**2T - Gasolina Mix 4%**

**Óleo (não incluído)**  
Aceite (no incluido)  
Oil (not included)

**Mix 4% - Ref. 25208**

<b>RPM</b>	<b>7500</b>
<b>Depósito Combustível / Depósito Combustible / Fuel Tank</b>	<b>0.6 L</b>
<b>Ruído / Noise</b>	<b>108db(A)</b>

N. Ref.	Descrição	Marca	Quant. Caixa
69541	PODAD SEBE-MGD-25,4CC 550MM PR	MADER GARDEN TOOLS	1

**COM PROTEÇÃO DA LÂMINA**  
CON PROTECCIÓN DE LA ESPADA  
WITH BLADE PROTECTION

para | for Ref.:  
69332 - 69344 - 69349

para Tesoura de Podar a Bateria  
para Tijera de Podar a Bateria  
for Battery Pruning Shear



69379



5602225693798

**LÂMINA + BATENTE**  
LÁMINA + TOPE  
BLADE + DOWN BLADE



69382



5602225693828

**BATENTE DE LÂMINA**  
TOPE DE LA LÁMINA  
DOWN BLADE



16.8V - 2.0Ah



69381



5602225693811

**BATERIA**  
BATERÍA  
BATTERY



Tempo de Carga / Tiempo Carga / Charging Time **15 - 2h**

16.8 V



69384



5602225693842

**CARREGADOR**  
CARGADOR  
CHARGER



LED indicador de carga  
LED charging indicator

Tensão / Tensión / Voltage **230V- 50Hz**

N. Ref.	Descrição	Marca	Quant. Caixa
69379	LAMIN+BATENT-MGD-P/TES POD 2UN	MADER GARDEN TOOLS	1/1
69382	BATENTE P/TES PODAR-MGD	MADER GARDEN TOOLS	1/1
69381	BAT P/TES PODAR-MGD-16,8V	MADER GARDEN TOOLS	1/1
69384	CARREG BAT TES PODAR-MGD-16,8V	MADER GARDEN TOOLS	1/1

para | for Ref.:  
69332 - 69344 - 69349 - 69381

### TESOURA DE PODAR

TIJERA DE PODA  
PRUNING SHEAR

Bateria de Lítio  
Batería de Lítio  
Lithium Battery



69349

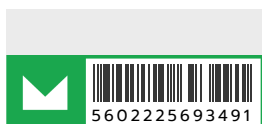

5602225693491



69344



5602225693446

com Visor  
con Pantalla  
with Display

#### Visor indica:

- Amplitude de cort
- Contagem de n.º de corte
- Percentagem restante da bateri

#### La pantalla lo indica:

- Amplitud de cort
- Recuento del número de corte
- Porcentaje de batería restant

#### Display indicates:

- Cutting amplitud
- Counting of no. of cut
- Remaining battery percentag



Ø 28mm (max.)  
Ø 15mm (min.)

**16.8V - 2.0Ah**

**Inclui 2 Baterias**  
Incluye 2 Baterías  
2 Batteries included

Autonomia / Autonomy	2 - 3h
Tempo de Carga / Tiempo Carga / Charging Time	15 - 2h

N. Ref.	Descrição	Marca	Quant. Caixa
69349	TESOURA POD-MGD-BAT 16,8V 2AH	MADER GARDEN TOOLS	10
69344	TESOUR POD-MGD-BAT 16,8V VISOR	MADER GARDEN TOOLS	10

Bateria | Batería | Battery: 2 un  
Carregador | Cargador | Charger: 1 un  
Mala de Transporte | Maletín de Transporte  
Carrying Case: 1 un  
Chave | Llave | Wrench: 4 un  
Lima | File: 1 un  
Lubrificante | Lubricante | Lubricant: 1 un

## BATERIA BATERÍA BATTERY

7.2V - 1.5Ah



**Tempo de Carga / Tiempo Carga**  
/ Charging Time  
**3 - 5h**

**para Tesoura de Podar (69341)**  
para Tijera de Podar (69341)  
for Pruning Shear (69341)

**para novo modelo,**  
**após outubro 2022**  
para nuevo modelo,  
de outubro de 2022  
for new model,  
after October 2022

N. Ref.	Descrição	Marca	Quant. Caixa
69348	BATERIA P/TES PODAR-MGD-7,2V	MADER GARDEN TOOLS	1



9 V - 0,4 A

## CARREGADOR CARGADOR CHARGER



<b>Para Modelo / Para El Modelo / For Model</b>	<b>69341</b>
<b>Tensão / Tensión / Voltage</b>	<b>230V~ 50Hz</b>

N. Ref.	Descrição	Marca	Quant. Caixa
69366	CARREGADOR-MGD-P/TES POD 69341	MADER GARDEN TOOLS	1



1 un

## LÂMINA HOJA BLADE



N. Ref.	Descrição	Marca	Quant. Caixa
69365	LAMINA P/TES PODAR 69341-MGD	MADER GARDEN TOOLS	1

para | to  
Ref: 69340

**para Tesoura de Podar a Bateria**  
para Tijera de Podar a Bateria  
for Battery Pruning Shear



## BATENTE TOPE DE LA LÁMINA BLADE



## LÂMINA HOJA BLADE

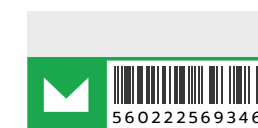

N. Ref.	Descrição	Marca	Quant. Caixa
69346	BATENTE P/TES PODAR-MGD	MADER GARDEN TOOLS	1
69347	LAMINA P/TES PODAR-MGD	MADER GARDEN TOOLS	1

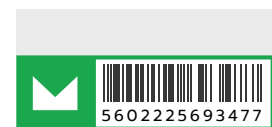

**SERRA DE PODAR**  
SIERRA DE PODAR  
PRUNING CHAIN SAW

### BRUSHLESS

com Depósito de Óleo e  
Lubrificação automática da Corrente

con Depósito de Aceite y  
Lubricación automática de la Cadena

with Oil tank and  
Automatic chain Lubrication

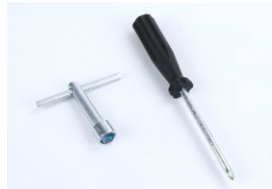

**2 Baterias**



69461



5602225694610

**7"**  
**21 V / 5.2 Ah**

<b>Potência / Potencia / Power</b>	<b>800 W</b>
<b>Carga / Load</b>	<b>2 - 3 h</b>
<b>Autonomia / Autonomy</b>	<b>2 - 2.5h</b>
<b>Corte / Cortada / Section</b>	<b>175 mm</b>
<b>Velocidade / Velocidad / Speed</b>	<b>11 m/s</b>

N. Ref.	Descrição	Marca	Quant. Caixa
69461	SERRA DE PODAR-MGD-BAT 21V-6"	MADER GARDEN TOOLS	1/5



**1.4" x 0.043" (1.1mm) - 48 Elos**

Óleo para Corrente - 25204 - 1L  
Aceite para Cadena - 25204 - 1L  
Chain Oil - 25204 - 1L

**BATERIA**  
BATERIA  
BATERIA



para 69461  
for 69461



69468



5602225694689

**21 V**  
**5.2 Ah**



69469



5602225694696

<b>Carga / Load</b>	<b>15 - 25 h</b>
<b>Autonomia / Autonomy</b>	<b>2 - 2.5 h</b>

N. Ref.	Descrição	Marca	Quant. Caixa
69468	BAT P/SERRA POD-MGD-6" 5.2AH	MADER GARDEN TOOLS	1
69469	CARREGADOR P/SERR POD-MGD-6"	MADER GARDEN TOOLS	1

**DC 21V - 2A**  
**230V~ 50Hz**

## BATERIA BATERIA BATERIA



**21 V**  
**4.0 Ah**



PARA REF: 69475, 48504 (SAU)

100% da bateria pode funcionar cerca de 60 minutos sem carga, e pode ir a 300 ciclos. Isto significa que a vida útil é de cerca de 18000 minutos para uma bateria (sem carga)

Carga / Load	4 - 6 h
Autonomia / Autonomy	60 min
Tempo de Trabalho / Tiempo Trabajo / Working Time	18000 min

N. Ref.	Descrição	Marca	Quant. Caixa
69476	BATERIA P/SERR POD-MGD-4AH 21V	MADER GARDEN TOOLS	8

## CARREGADOR CARREGADOR CARREGADOR

para/ for 69352



**21 V**  
**1 A**



para/ for 69470

## BATERIA BATERIA BATERIA

**21 V**  
**2.0 Ah**

Para Modelo / Para El Modelo / For Model	69352	Para Modelo / Para El Modelo / For Model	69470
Tensão / Tensión / Voltage	230V~ 50Hz	Tempo de Carga / Tiempo Carga / Charging Time	13h

N. Ref.	Descrição	Quant. Caixa	N. Ref.	Descrição	Quant. Caixa
69386	CARREGADOR-MGD-P/69352	1	69482	BATERIA P/SERR POD-MGD-2AH 21V	4

## LÂMINA ESPADA BLADE

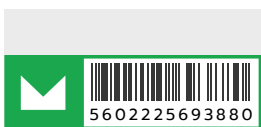

**4" - 100 mm**  
**0,043"(1,1mm)**



para 69352  
for 69352

N. Ref.	Descrição	Marca	Quant. Caixa
69388	LÂMINA-MGD-P/69352	MADER GARDEN TOOLS	1

## BATERIA BATERIA BATTERY

**1.5Ah**  
**16.8V**



## CARREGADOR CARGADOR CHARGER

**16.8V - 1A**

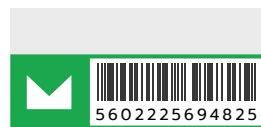

Para Modelo / Para El Modelo / For Model	69480	Para Modelo / Para El Modelo / For Model	69480
Tempo de Carga / Tiempo Carga / Charging Time	1 - 15h (1A)	Tensão / Tensión / Voltage	230V~ 50Hz

N. Ref.	Descrição	Quant. Caixa	N. Ref.	Descrição	Quant. Caixa
69481	BATERIA-MGD-16.8V1.5AH P/69480	4	69482	CARREGADOR-MGD-16.8V1A P/69480	4

**ELETROSSERRA**  
ELECTROSSIERRA  
ELECTRIC CHAIN SAW

**Motor Elétrico**  
Motor Eléctrico  
Electric Motor

**Sistema SDS**  
SDS System



**3/8" MINI - 57 Elos - 0.050" (1.3mm)**



**LUZ ATIVIDADE**  
LUZ ACTIVIDAD  
ACTIVITY LIGHT

**Óleo » Corrente: ref. 25204**



**1800W**  
16" (400mm)



**2200W**  
16" (400mm)



**2400W**  
16" (400mm)

**Sistema SDS - Ajuste Rápido da Corrente**  
Sistema SDS - Ajuste Rápido da Corriente  
SDS System - Fast Current Adjustment

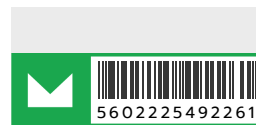
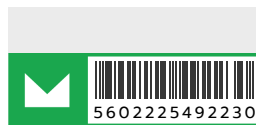
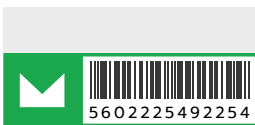

<b>Tensão / Tensión / Voltage</b>	<b>230V~ 50Hz</b>	<b>230V~ 50Hz</b>	<b>230V~ 50Hz</b>
<b>Velocidade da Corrente / Velocidad de la Cadena</b>	<b>15 m/s (Stop &lt; 0.12 s)</b>	<b>13 m/s (Stop &lt; 0.12 s)</b>	<b>13 m/s (Stop &lt; 0.12 s)</b>
<b>Depósito Óleo / Depósito De Aceite / Oil Deposit</b>	<b>280 mL</b>	<b>135 mL</b>	<b>280 mL</b>
<b>Ruído / Noise</b>	<b>107 dB</b>	<b>107 dB</b>	<b>112 dB</b>

N. Ref.	Descrição	Marca	Quant. Caixa
49225	ELETROSSERRA-MGD-1800W 400MM	MADER GARDEN TOOLS	1
49223	ELETROSSERRA-MGD-2200W 400MM HT	MADER GARDEN TOOLS	1
49226	ELETROSSERRA-MGD-2400W 400MM	MADER GARDEN TOOLS	1

### MOTOSSERRA MOTOSIERRA CHAIN SAW



3/8" MINI - 40 Elos - 0.050" (1.3mm)



**25.4 cc**  
10" (250mm)

Potência / Potencia / Power	<b>0.7 kW</b>
RPM	<b>12 000</b>
Depósito Combustível / Depósito Combustible / Fuel Tank	<b>230 mL</b>
Depósito Óleo / Depósito De Aceite / Oil Deposit	<b>160 mL</b>
Ruído / Noise	<b>112 dB</b>

N. Ref.	Descrição	Marca	Quant. Caixa
69500	MOTOSSERRA-MGD-25.4CC 10"	MADER GARDEN TOOLS	1/2

### PODADORA PRUNER



2T - Gasolina Mix 4%  
2S - Gasoline Mix 4%

Mix 4% - Ref. 25208

Óleo » Corrente: ref. 25204  
Aceite » Cadena: ref. 25204  
Oil » Chain: ref. 25204

### MOTOSSERRA MOTOSIERRA CHAIN SAW

DESIGN MODERNO E ATRATIVO  
DISEÑO MODERNO Y ATRACTIVO  
MODERN AND ATTRACTIVE DESIGN

### PODADORA PRUNER

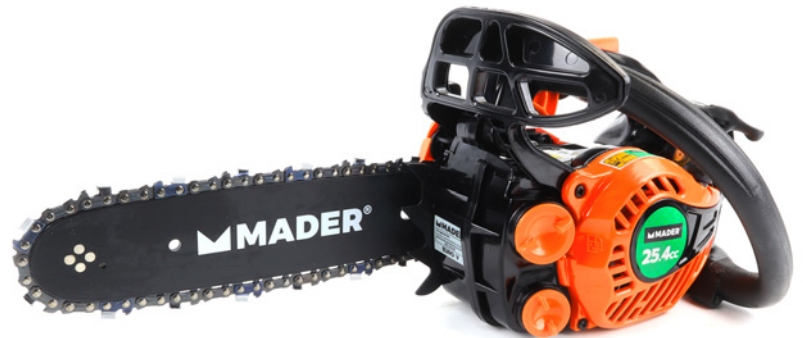

**2.99 Kg**

3/8" MINI - 40 Elos - 0.050" (1.3mm)

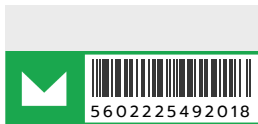

**25.4 cc**  
10" (255mm)

Potência / Potencia / Power	<b>0.75 kW</b>
RPM	<b>7500</b>
Depósito Combustível / Depósito Combustible / Fuel Tank	<b>190 mL</b>
Depósito Óleo / Depósito De Aceite / Oil Deposit	<b>140 mL</b>
Ruído / Noise	<b>111 dB (A)</b>

N. Ref.	Descrição	Marca	Quant. Caixa
49201	MOTOSSERRA-MGD-25.4CC 10" ET25	MADER GARDEN TOOLS	1/1



2T - Gasolina Mix 4%  
2S - Gasoline Mix 4%

Mix 4% - Ref. 25208

Óleo » Corrente: ref. 25204  
Aceite » Cadena: ref. 25204  
Oil » Chain: ref. 25204

**MOTOSSERRA**  
MOTOSIERRA  
CHAIN SAW

**PODADORA**  
PRUNER



**PROFISSIONAL**  
PROFESIONAL  
PROFESSIONAL

## WALBRO®

**Carburador Japonês**  
Carburador Japonés  
Japanese Carburetor

## CARVING

**Lâmina para Esculpir**  
Espada para Tallar  
Blade to Carve

**1/4" MINI - 60 Elos - 0.050" (1.3mm)**

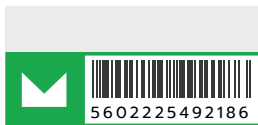

**25.4 cc**  
**10" (250mm)**



**2T - Gasolina Mix 4%**  
**2S - Gasoline Mix 4%**

**Mix 4% - Ref. 25208**

**Óleo » Corrente: ref. 25204**  
**Aceite » Cadena: ref. 25204**  
**Oil » Chain: ref. 25204**



**Caixa Colorida**  
Caja de Color  
Color Box

<b>Potência / Potencia / Power</b>	<b>0.9 kW</b>
<b>RPM</b>	<b>11 000</b>
<b>Depósito Combustível / Depósito Combustible / Fuel Tank</b>	<b>230 mL</b>
<b>Depósito Óleo / Depósito De Aceite / Oil Deposit</b>	<b>160mL</b>
<b>Ruído / Noise</b>	<b>113 dB</b>

N. Ref.	Descrição	Marca	Quant. Caixa
49218	MOTOSSERRA-MGD-25.4CC 10" CARV	MADER GARDEN TOOLS	2

**CARBURADOR**  
CARBURADOR  
CARBURATOR

## WALBRO

» **MOTOSSERRA**  
» **MOTOSIERRA**  
» **CHAIN SAW**

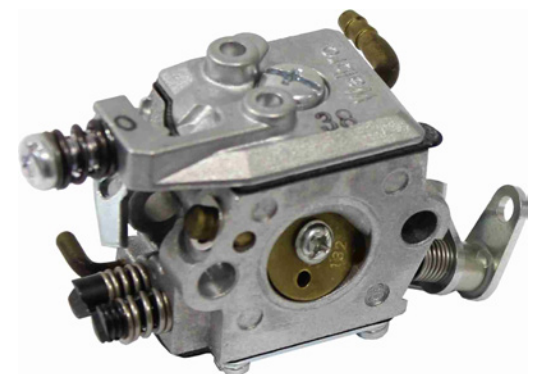

**Para Modelo / Para El Modelo / For Model** **49205-49218-69500 (25.4cc)**

N. Ref.	Descrição	Marca	Quant. Caixa
69283	CARBURADOR P/MOTOSSERRA 25.4CC	MADER GARDEN TOOLS	100/100

### MOTOSSERRA MOTOSIERRA CHAIN SAW

### PODADORA PRUNER



3/8" - 45 Elos - 0.050" (1.3mm)



**25.4 cc**  
12" (300mm)

Potência / Potencia / Power	1 kW
RPM	8500
Depósito Combustível / Depósito Combustible / Fuel Tank	190 mL
Depósito Óleo / Depósito De Aceite / Oil Deposit	140 mL
Ruído / Noise	113 dB



2T - Gasolina Mix 4%  
2S - Gasoline Mix 4%

Mix 4% - Ref. 25208

Óleo » Corrente: ref. 25204  
Aceite » Cadena: ref. 25204  
Oil » Chain: ref. 25204

N. Ref.	Descrição	Marca	Quant. Caixa
69502	MOTOSSERRA-MGD-25.4CC 12"	MADER GARDEN TOOLS	2/2

### LÂMINA PARA MOTOSSERRA ESPADA PARA MOTOSSIERRA BLADE FOR CHAIN SAW



**12" - 0,050"**  
45 Elos - 3/8"



Para Modelo / Para El Modelo / For Model **para 69502**

N. Ref.	Descrição	Marca	Quant. Caixa
69490	LÂMINA P/MOTOSS 12"-MGD-3/8"	MADER GARDEN TOOLS	1/20

### CORRENTE PARA MOTOSSERRA CADENA PARA MOTOSSIERRA SAW CHAIN



**45 Elos - 3/8"**  
12" - 0,050"



Para Modelo / Para El Modelo / For Model **para 69502**

N. Ref.	Descrição	Marca	Quant. Caixa
69491	CORRENTE P/MOTOSSE-MGD-12" 45E	MADER GARDEN TOOLS	1/60

**MOTOSSERRA**  
**MOTOSIERRA**  
**CHAIN SAW**

0.325" - 72 Elos - 0.050" (1.3mm)



**ARRANQUE SUAVE**  
**SMOOTH START**



**2T - Gasolina Mix 4%**  
**2S - Gasoline Mix 4%**

**Mix 4% - Ref. 25208**

**Óleo » Corrente: ref. 25204**  
**Aceite » Cadena: ref. 25204**  
**Oil » Chain: ref. 25204**

**Caixa Colorida**  
**Caja de Color**  
**Color Box**



**46cc**  
**18" (450mm)**

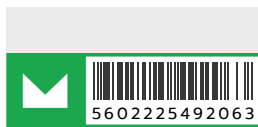

**53cc**  
**18" (450mm)**

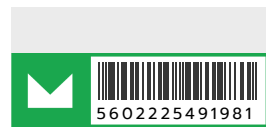

<b>Potência / Potencia / Power</b>	<b>2.0kW - 2.7Hp</b>	<b>2.2kW - 3.0Hp</b>
<b>RPM</b>	<b>11 000</b>	<b>11 000</b>
<b>Depósito Combustível / Depósito Combustible / Fuel Tank</b>	<b>550mL</b>	<b>550mL</b>
<b>Depósito Óleo / Depósito De Aceite / Oil Deposit</b>	<b>260mL</b>	<b>260mL</b>
<b>Ruído / Noise</b>	<b>114 dB</b>	<b>114 dB</b>

N. Ref.	Descrição	Marca	Quant. Caixa
49206	MOTOSSERRA-MGD-46CC 18"	MADER GARDEN TOOLS	2
49198	MOTOSSERRA-MGD-53CC 18"	MADER GARDEN TOOLS	2

# MADER®

# GARDEN TOOLS

**MOTOSSERRA**  
MOTOSIERRA  
CHAIN SAW

**ARRANQUE SUAVE**  
SMOOTH START



**Abertura do Ar ao Carburador**  
**AUTOMÁTICA**

Apertura de Aire al Carburador  
**AUTOMÁTICO**  
Carburetor Air Vent  
**AUTOMATIC**

**0.325" - 72 Elos - 0.058" (1.5mm)**

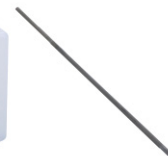

49195



5602225491950

**54cc**

**18" (450mm)**

Potência / Potencia / Power	<b>2.2kW</b>
RPM	<b>7500</b>
Depósito Combustível / Depósito Combustible / Fuel Tank	<b>550mL</b>
Depósito Óleo / Depósito De Aceite / Oil Deposit	<b>260mL</b>
Ruído / Noise	<b>110 dB</b>

N. Ref.	Descrição	Marca	Quant. Caixa
49195	MOTOSSERRA-MGD-54CC 18"	MADER GARDEN TOOLS	1



**2T - Gasolina Mix 4%**  
**2S - Gasoline Mix 4%**

**Mix 4% - Ref. 25208**

**Óleo » Corrente: ref. 25204**  
**Aceite » Cadena: ref. 25204**  
**Oil » Chain: ref. 25204**

**MADER**

# TRABALHA COMO UM PROFISSIONAL

24JUN18

105

**MOTOSSERRA**  
MOTOSIERRA  
CHAIN SAW

**Semi-Profissional**  
Semiprofesional  
Semi professional

**ARRANQUE SUAVE**  
SMOOTH START



**0.325" - 72E - 0.058" (1.5mm)**

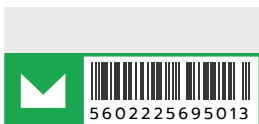

**55cc**  
18" (450mm)



Com bomba gasolina para ferrar o carburador  
Con bomba gasolina para llegar al carburador  
With gasoline pump to hit carburetor

**0.325" - 76E - 0.058" (1.5mm)**



**55cc**  
20" (500mm)



Potência / Potencia / Power	<b>2.5kW - 3.4Hp</b>
RPM	<b>10 000</b>
Filtro Ar / Filtro de aire / Air Filter	<b>Papel</b>
Depósito Combustível / Depósito Combustible / Fuel Tank	<b>550mL</b>
Depósito Óleo / Depósito De Aceite / Oil Deposit	<b>260mL</b>
Ruído / Noise	<b>116 dB</b>

**2T - Gasolina Mix 4%**  
2S - Gasoline Mix 4%

**Mix 4% - Ref. 25208**

**Óleo » Corrente: ref. 25204**  
Aceite » Cadena: ref. 25204  
Oil » Chain: ref. 25204



N. Ref.	Descrição	Marca	Quant. Caixa
69501	MOTOSSERRA-MGD-55CC 18"	MADER GARDEN TOOLS	2/2
49199	MOTOSSERRA-MGD-55CC 20"	MADER GARDEN TOOLS	1

**FILTRO DE AR**  
FILTRO DE AIRE  
AIR FILTER



**Para Modelo / Para El Modelo / For Model** **49199**

N. Ref.	Descrição	Marca	Quant. Caixa
49216	FILTRO-MGD-P/MOTOSERRA 49199	MADER GARDEN TOOLS	100

# MADER®

## GARDEN TOOLS

**MOTOSSERRA**  
MOTOSIERRA  
CHAIN SAW

**ARRANQUE SUAVE**  
SMOOTH START



**Abertura do Ar ao Carburador**  
**AUTOMÁTICA**

Apertura de Aire al Carburador  
**AUTOMÁTICO**  
Carburetor Air Vent  
**AUTOMATIC**

**0.325" - 76 Elos - 0.058" (1.5mm)**

**Reforçado (metálico)**  
Reforzado (metálico)  
Reinforced (metálic)



**Filtro Ar - Revestido a Felpo (Película)**  
Filtro Aire - Recubierto de Tela (Película)  
Air Filter - Coated Cloth (Film)

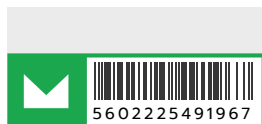

**58cc**  
20" (500mm)

<b>Potência / Potencia / Power</b>	<b>2.4kW</b>
<b>RPM</b>	<b>12 000</b>
<b>Depósito Combustível / Depósito Combustible / Fuel Tank</b>	<b>550mL</b>
<b>Depósito Óleo / Depósito De Aceite / Oil Deposit</b>	<b>260mL</b>
<b>Ruído / Noise</b>	<b>113 dB</b>

N. Ref.	Descrição	Marca	Quant. Caixa
49196	MOTOSSERRA-MGD-58CC 20"	MADER GARDEN TOOLS	1



**2T - Gasolina Mix 4%**  
2S - Gasoline Mix 4%

**Mix 4% - Ref. 25208**

**Óleo » Corrente: ref. 25204**  
Aceite » Cadena: ref. 25204  
Oil » Chain: ref. 25204

**MADER**

**TRABALHA COMO UM PROFISSIONAL**

24JUN18

107

### ÓLEO PARA CORRENTE ACEITE PARA CADENAS CHAIN OIL

» **Motosserra**  
» **Motosierra**  
» **Chainsaw**

**Aditivos: Antioxidantes e Inibidores de Corrosão**  
Aditivos: Antioxidantes e Inhibidores de la Corrosión  
Additives: Antioxidants and Corrosion Inhibitors

**1 L**

**5 L**

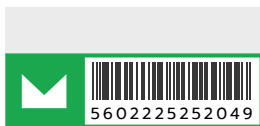

N. Ref.	Descrição	Marca	Quant. Caixa
25204	ÓLEO-MGD-CORR.MOTOSERRA 1L	MADER GARDEN TOOLS	12/12
25205	ÓLEO-MGD-CORR.MOTOSERRA 5L	MADER GARDEN TOOLS	4/4

### ÓLEO SINTÉTICO ACEITE SINTÉTICO SYNTHETIC OIL

**Motosserra e Roçadora**  
**Motosierra y Desbrozadora**  
**Chainsaw and Brushcutter**

**2T**



**Motor 2 Tempos » 4% (25:1)**  
**40 ml por cada 1L de gasolina**  
Motor 2 Tiempos » 4% (25:1)  
40 ml por cada 1L de gasolina  
2-Stroke Engine » 4% (25:1)  
40 ml for every 1L of gasoline



**1/8 L**  
125 mL



**200 mL**



**1 L**



**1 L**



**COM DOSEADOR**  
**| CON DOSIFICADOR**  
**| WITH DOSER**  
**50 ML - 100 ML**



### LUBRIFICANTE » MOTORES REFRIGERADOS POR AR LUBRICANTE » MOTORES REFRIGERADOS POR AIRE AIR-COOLED ENGINE LUBRICANT

N. Ref.	Descrição	Marca	Quant. Caixa
25202	ÓLEO-MGD-2T SINTÉTICO 1/8L	MADER GARDEN TOOLS	20/20
25198	ÓLEO-MGD-2T SINTÉTICO 200ML	MADER GARDEN TOOLS	1/20
25208	ÓLEO-MGD-2T SINTÉTICO 1L	MADER GARDEN TOOLS	12/20
25196	ÓLEO-MGD-2T SINT 1L DOSE-100ML	MADER GARDEN TOOLS	12/12



**p/ Misturar c/ gasolina 95/98**  
**» 4% Óleo**  
**p/ Mezclar c/ gasolina 95/98**  
**» 4% Aceite**  
**for Mixing with 95/98 gasoline**  
**» 4% Oil**

### ÓLEO LUBRICANTE OIL

**Motoenxadas, Corta-Relvas, Geradores**  
Motoazada, Cortacéspedes, Generadores  
Motor Hoes, Lawn Mowers, Generators

### 4 T

**SEMI-SINTÉTICO, Multiválvulas**  
SEMI SINTETICO, Multivalvulas  
SEMI-SYNTHETIC, Multivalve

**Lubrificante » Motor Multigraduado**  
Lubricante » Motor Multigraduado  
Lubricant » Multigrade Engine



## 10W40

1 L

N. Ref.	Descrição	Marca	Quant. Caixa
25203	ÓLEO-MGD-4T (10W40) 1L	MADER GARDEN TOOLS	6/12

### VALVULINA VALVULINA VALVULINE

**Motoenxadas, Motocultivador**  
Motoazada, Motocultor  
Motor Hoes, Tiller

**Transmissões Mecânicas**  
Transmisiones Mecánicas  
Mechanical Transmissions



## 80W90

1 L

N. Ref.	Descrição	Marca	Quant. Caixa
25200	VALVULINA-MGD-1L 80W90	MADER GARDEN TOOLS	12/12

### ÓLEO LUBRICANTE OIL

**Rachador Lenha**  
Tronzador de Leña  
Log Splitter

**ANTI DESGASTE - BOA VISCOSIDADE**  
ANTI DESGASTE - BUENA VISCOSIDAD  
ANTI WEAR - GOOD VISCOSITY

**Lubrificante para Circuitos Hidráulicos**  
Lubricante para Circuitos Hidráulicos  
Lubricant para Hydraulic Circuits

## HLP 46

1 L

5 L



N. Ref.	Descrição	Marca	Quant. Caixa
25224	ÓLEO P/HIDRAUL-MGD-46WG20 1L	MADER GARDEN TOOLS	4/4
25213	ÓLEO P/HIDRAUL -MHM-46WG20 5L	MADER GARDEN TOOLS	4/4

## ÓLEO MULTIUSOS LUBRICANTE MULTIUSOS MULTIPURPOSE OIL

**ISO-22**

Para lubrificação de máquinas de pequeno porte, como máquinas de podar e eletrosserras. Pode ainda aplicar este produto em fechaduras, máquinas de costura, dobradiças, ou seja, lubrificações no geral. Assim sendo, pode utilizar este óleo para a lubrificação em ambientes de bricolage, domésticos e até profissionais.



**150 mL**



Para lubrificar máquinas pequenas como podadoras y electrosierras. También puede aplicar este producto a cerraduras, máquinas de coser, bisagras, es decir, a la lubricación en general. Por lo tanto, puede utilizar este aceite para la lubricación en entornos de bricolaje, domésticos e incluso profesionales.

N. Ref.	Descrição	Marca	Quant. Caixa
25197	ÓLEO MULTIUSOS-MGD-150ML	MADER GARDEN TOOLS	5/20

## MASSA MULTIUSOS GRASA MULTIUSOS MULTIPURPOSE GREASE

A massa consistente de lítio com aditivos antioxidantes, anticorrosivos e extrema pressão é útil para lubrificar engrenagens, carretos, transmissões

**MASSA LÍTICA  
GRASA LÍTICA  
LITHIC GREASE**

**MASSA  
GRAFITADA  
GRASA GRAFITO  
GRAPHITE GREASE**

Massa Multiusos de Grafite para aplicações automotrizes e industriais; Resistência a temperaturas: -35°C a +140°C. Particularmente útil em casos de movimentos oscilantes e bruscos;

Resistente à água; Boa proteção conta a corrosão;



**150 g**  
-30°C a 130°C



**200 g**  
-35°C a 140°C

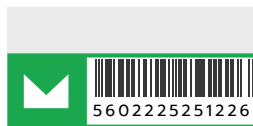

N. Ref.	Descrição	Marca	Quant. Caixa
25218	MASSA CONSIST LÍTIO-MPT-150GR	MADER POWER TOOLS	1/20
25222	MASSA CONSIS GRAFITAD-MPT-200G	MADER POWER TOOLS	1/1

**A EMBALAGEM FACILITA A SUA APLICAÇÃO**  
LA EMBALAJE FACILITA SU APLICACIÓN  
THE PACKAGING FACILITATES ITS APPLICATION

## BOMBA EXTRATORA BOMBA EXTRACTORA EXTRACTOR PUMP

**SERINGA  
JERINGA  
SYRINGE**

**EXTRATOR ÓLEO  
EXTRACTOR ACEITE  
OIL EXTRACTOR**

**TUBO DESCONEXÃO RÁPIDA  
TUBO DESCONEXIÓN RÁPIDA  
QUICK DISCONNECT TUBE**

**4 un**



**500 mL**

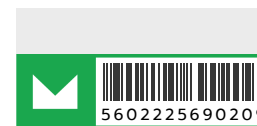

Bomba | Pump: 1 un - 300 mL  
Funil | Embudo | Funnel: 1 un  
Tubo | Tube: 1 un - 255 mm  
Reservatório | Depósito | Reservoir: 1 un - 1000 mL



N. Ref.	Descrição	Marca	Quant. Caixa
69020	KIT BOMBA EXTRATO ÓLEO-MGD-4UN	MADER GARDEN TOOLS	1/1
63042	SERINGA P/ÓLEO-MPT-500ML	MADER POWER TOOLS	1/20

Para remover óleo de caixas de velocidades e motores  
Para utilização com líquido dos travões/ anticongelante  
Aspiração e alimentação de óleos de engrenagens, etc.

## VELA BUJÍA SPARK PLUG



- Embalagem Individual
- Caixa Master de 10un

AVULSO

BLISTER



19mm - M14 x 1,25 - 9,5 mm



21mm

M14 x 1,25 - 17 mm



16mm

M10 x 1,0 - 12,7 mm

Descrição: Vela

Marca: Mader Garden

N. Ref.	Especificação	Quant. Caixa:
61501	19mm - M14 - Avulso	100
61500	19mm - M14 - Blister	36
61502	21mm - M14 - Blister	36
61503	16mm - M10 - Blister	36

## CHAVE DE VELAS LLAVE DE BUJÍAS SPARK PLUG WRENCH



COM CHAVE DE FENDAS  
CON DESTORNILLADOR  
WITH SCREWDRIVER



UNIVERSAL

Descrição: Chave de Velas

Marca: Mader Garden

N. Ref.	Especificação	Quant. Caixa:
69290	c/ Chave Fendas - 14/19 mm	100

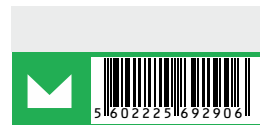

## CHAVE MULTIFUNÇÕES » MOTOSSERRA LLAVE MULTIFUNCIONES » MOTOSIERRA MULTI TOOL » CHAIN SAW

MANUTENÇÃO / REPARAÇÃO  
MANTENIMIENTO / REPARACIÓN  
MAINTENANCE / REPAIR

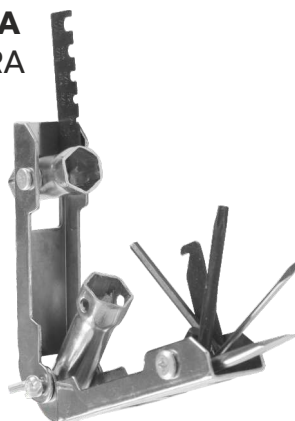

UNIVERSAL



17 Chaves

C/ BOLSA  
W/ BAG



Descrição: Chave Multifunções

Marca: Mader Garden

N. Ref.	Especificação	Quant. Caixa:
69289	p/ Motosserra	20

## CORDA DE ARRANQUE CUERDA DE ARRANQUE START ROPE



**3,6~3,8mm**  
100 m



**4,5mm**  
100 m

Descrição:	Corda de Arranque	
Marca:	Mader Garden	
N. Ref.	Especificação	Quant. Caixa:
69321	3,6~3,8 mm - 100 m	30
69197	4,5 mm - 100 m	10

## SISTEMA DE ARRANQUE STARTING SYSTEM

**Manual**



Para /For:  
(49205) - 25.4cc



Para /For:  
(49196) - 58cc



Descrição:	Sistema de Arranque	
Marca:	Mader Garden	
N. Ref.	Especificação	Quant. Caixa:
69233	p/ Motosserra (49205)	38
03440	p/ Motosserra (49196)	1

## CHAVE AFINAÇÃO » CARBURADOR LLAVE REGULADORA » CARBURADOR CARBURETOR ADJUSTER



**35-60**  
PAC MAN



**35-61**  
SPLINED



**35-62**  
SINGLE D



**35-63**  
DOUBLE D

Descrição:	Chave Afinação » Carburador	
Marca:	Mader Garden	
N. Ref.	Especificação	Quant. Caixa:
69285	35 - 60 - Pac Man	50
69286	35 - 61 - Splined	50
69287	35 - 62 - Single D	50
69288	35 - 63 - Double D	50
69324	CY - 05 - Hexagon	50
69325	CY - 06 - Splined	50



**CY-05**  
HEXAGON



**CY-06**  
SPLINED



## ESCOVA DE CARBURADOR CEPILLO DE CARBURADOR CARBURETOR BRUSH

para Limpeza  
para Limpieza  
for Cleaning



12 un

N. Ref.	Descrição	Marca	Quant. Caixa
69380	ESCOVA P/CARBURADOR-MGD	MADER GARDEN TOOLS	240

## CHAVE PARA RETIRAR FILTRO LLAVE PARA SACAR FILTRO FILTER HOOK

para Motor Explosão  
para Motor Explosión  
for Explosion Engine



N. Ref.	Descrição	Marca	Quant. Caixa
69322	CH RETIRAR FILTRO-MGD-P/MOTOR	MADER GARDEN TOOLS	40

## CHAVE PARA RETIRAR EMBRAIAGEM LLAVE PARA SACAR EMBRAGUE FLY WHEEL TOOL

para Motor Explosão  
para Motor Explosión  
for Explosion Engine

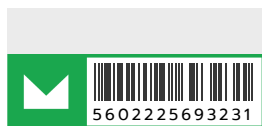

N. Ref.	Descrição	Marca	Quant. Caixa
69323	DISPOSIT-MGD-RETIRAR EMBRAIAG	MADER GARDEN TOOLS	25

### AFIADOR CORRENTE AFILADORA CADENA CHAIN SAW SHARPENER



C/ BOLSA  
W/ BAG

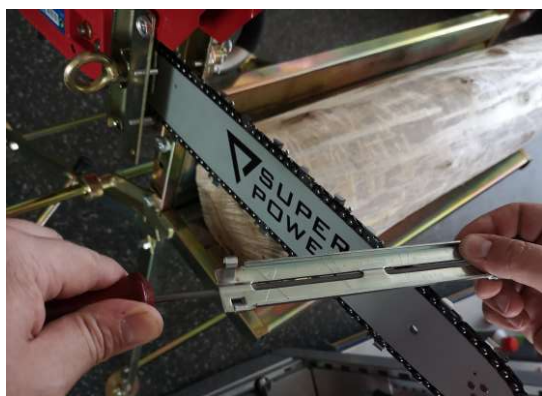

4,0mm » 5/32"



4,8mm » 3/16"

Corrente / Cadena / Chain

1/4" - 3/8" MINI

0.325"

Descrição: Afiador de Corrente

Marca: Mader Garden

N. Ref.	Especificação	Quant.	Caixa:
69453	p/ Cor. 1/4" e 3/8" mini - 4 mm	4	
69454	p/ Cor. 0,325" - 4,8 mm	4	

### CARBURADOR CARBURADOR CARBURETOR

para/to  
ROÇADORA | DESBROZADORA  
63.3cc

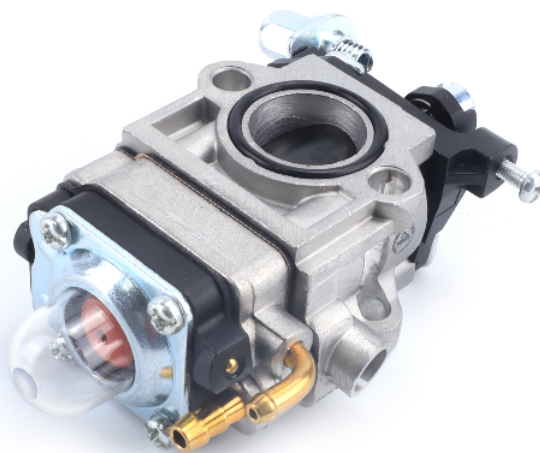

N. Ref.	Descrição	Marca	Quant. Caixa
49219	CARBURADOR	MADER GARDEN TOOLS	25/1

## AFIADOR DE CORRENTE AFILADOR DE CADENA CHAIN SHARPENER

## UNIVERSAL



**220 W**  
100 mm



**1 Disco**  
1 Disc



**230 W**  
145 mm



**2 Disco**  
2 Disc



<b>RPM</b>	<b>7500</b>	<b>3000</b>
<b>Tensão / Tensión / Voltage</b>	<b>230V-50Hz</b>	<b>230V-50Hz</b>

N. Ref.	Descrição	Marca	Quant. Caixa
01006	AFIADOR CORRENTE-MGD-ELE 220W	MADER GARDEN TOOLS	6/6
01009	AFIADOR CORRENTE-MGD-ELE 230W-2D	MADER GARDEN TOOLS	3/3

## DISCO ABRASIVO DISCO ABRASIVO SAW DISK



**100 mm**  
3,2 x 10 mm

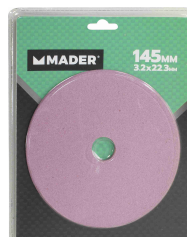

**145 mm**  
3,2 x 22,3 mm



N. Ref.	Descrição	Marca	Quant. Caixa
01010	DISCO P/AFIADOR-MGD-100X4,5X10	MADER GARDEN TOOLS	10/100
01011	DISCO P/AFIADOR-MGD-145X22,3MM	MADER GARDEN TOOLS	10/100

## CORRENTE PARA MOTOSSERRA CADENA PARA MOTOSIERRA SAW CHAIN

**1/4" - 60E**  
10" - 0,050"

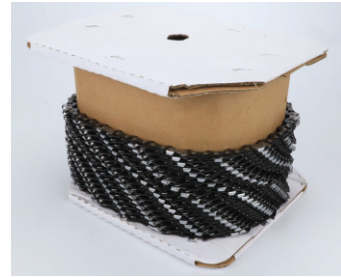

**3/8"mini-40E**  
10" - 0,050"



**3/8"mini-57E**  
16" - 0.050"



**3/8"mini-1640E**  
0.050"



**0.325" - 72E**  
18" - 0,050"



**0.325" - 76E**  
20" - 0.058"



**0.325"-1840E**  
0.050"



N. Ref.	Descrição	Marca	Quant. Caixa
49230	CORR P/MOTOS-MGD-1/4"X0.050"	MADER GARDEN TOOLS	5
49231	CORR P/MOTOS-MGD-1640E MINI3/8	MADER GARDEN TOOLS	5
49232	CORRENTE P/MOTOSSE-MGD-1840E 0.325	MADER GARDEN TOOLS	5
69496	CORRENTE P/MOTOSSE-MGD-10" 40E	MADER GARDEN TOOLS	5
69497	CORRENTE P/MOTOSSE-MGD-16" 57E	MADER GARDEN TOOLS	5
69498	CORRENTE P/MOTOSSE-MGD-18" 72E	MADER GARDEN TOOLS	5
69499	CORRENTE P/MOTOSSE-MGD-20" 76E	MADER GARDEN TOOLS	1



**1/4" - 60E**  
10" - 0,050"



**3/8"mini-40E**  
10" - 0,050"



**3/8"mini-57E**  
16" - 0,050"



**TITÂNIO**  
TITANIO  
TITANIUM

**0.325" - 72E**  
18" - 0,050"



**0.325" - 76E**  
20" - 0.058"

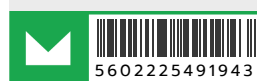

N. Ref.	Descrição	Marca	Quant. Caixa
49190	CORR MOTOSSE-MGD-10"1/4" TITAN	MADER GARDEN TOOLS	5
49191	CORR MOTOSSE-MGD-10"3/8" TITAN	MADER GARDEN TOOLS	5
49192	CORR MOTOSSE-MGD-16"3/8" TITAN	MADER GARDEN TOOLS	5
49193	CORR MOTOSS-MGD-18"0.325" TITA	MADER GARDEN TOOLS	5
49194	CORR MOTOSS-MGD-20"0.325" TITA	MADER GARDEN TOOLS	5

## UNIÕES DE CORRENTE CONEXIONES DE CADENA TIE STRAP

**FÊMEA**  
HEMBRA  
FEMALE



## ELO DE LIGAÇÃO ENLACE DE CONEXIÓN CONNECTION LINK



**MACHO**  
MALE



10un-3/8"Mini



10un - 0,325"

Descrição: Uniões de Corrente

Marca: Mader Garden

N. Ref. Especificação  
49233 3/8" Mini - 10 un

Quant. Caixa:

100

49234 0,325" - 10 un

150

## MÁQUINA CRAVAR / DESCRAVAR CORRENTE TRONCHA / REMACHADORA DE CADENA CHAIN BREAKER / RIVETER



N. Ref.	Descrição	Marca	Quant. Caixa
49215	MAQ CRAVAR/DESCRAVAR CORRENTE	MADER GARDEN TOOLS	1

Máquina de descravar  
Remachadora  
Riveter

Máquina de cravar  
Troncha  
Breaker

## LIMA » AFIAR CORRENTE LIMA » AFILADORA CADENA SAW FILE



4,0mm » 5/32"



4,8mm » 3/16"



5,0mm

3un



Corrente / Cadena / Chain  
1/4" - 3/8" MINI

Corrente / Cadena / Chain  
0.325"

Corrente / Cadena / Chain  
3/8" Prof. - 0.404"



2un

C/ CABO  
C/ MANGO  
W/ HANDLE



3/16"  
5/32"

Descrição: Lima » Afiar Correntes

Marca: Mader Garden

N. Re. Especificação  
69450 3 un - 4,0 mm

Quant. Caixa:

4

69451 3 un - 4,8 mm

4

69452 3 un - 5,0 mm

4

69293 3/16" - 5/32"

12

Corrente / Cadena / Chain



### LÂMINA P/ MOTOSSERRA ESPADA P/ MOTOSIERRA BLADE » CHAIN SAW



10"(250 mm)  
16"(400 mm)  
18"(450 mm)  
20"(500 mm)

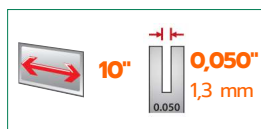

0,050" (1,3mm)  
0,058" (1,5mm)



10" - 0,050"  
40E - 3/8"MINI



10" - 0,050"  
60E - 1/4"



16" - 0,050"  
57E - 3/8"MINI



18" - 0,050"  
72E - 0,325"



20" - 0,058"  
78E - 0,325"

Descrição: Lâmina » Motosserra

Marca: Mader Garden

N. Ref.	Especificação	Quant.	Caixa:
49217	10"- 0,050" - 3/8"Mini - 40E	20	
49229	10"- 0,050" - CARVING	20	
66229	16"- 0,050" - 3/8"Mini - 57E	20	
49213	18"- 0,050" - 0,325" - 72E	20	
49214	20"- 0,058" - 0,325" - 76E	20	

### DISTRIBUIDOR 2 VELOCIDADES - MÁQUINA DESTROCAR LENHA DISTRIBUIDOR 2 VELOCIDADES - TRONZADOR DE LEÑA 2 SPEED DISTRIBUTOR - FIREWOOD SHREDDING MACHINE



01510



5602225015101

N. Ref.	Descrição	Marca	Quant. Caixa
01510	DISTRIBUID 2 VEL P/55156+55158	MADER	1

para REF. 55156 | REF. 55157  
for REF. 55156 | REF. 55157

## RACHADOR / DESTROÇADOR DE LENHA TRONZADOR DE LEÑA LOG SPLITTER



# HORIZONTAL

com Proteção  
con Protección  
with Protection



**2**  
VELOCIDADES | GEARS



**7 T**  
Ø320x520 mm

Ciclo de Trabalho / Ciclo de Trabajo / Duty Cycle	23 s
Potência / Potencia / Power	2300 W
RPM	2950
Velocidades / Cambio / Gears	2
Depósito Óleo / Depósito De Aceite / Oil Deposit	6 L (Telex E-46)
Pressão Max / Presión Máx / Pressure Max	2585 psi
Ruído / Noise	90 db(A)
Isolamento / Aislamiento / Insulation	IP 54
Medidas / Measures	1230 x 590 x 730 mm

**Elétrico - Monofásico**  
Eléctrico - Monofasico  
Electric - Single Phase



**Óleo Hidráulico (não incluído)**  
Aceite Hidráulico (no incluido)  
Hydraulic Oil (not included)

**Telex E46 - Recom. ref. 25213 - 5 L**

N. Ref.	Descrição	Marca	Quant. Caixa
65576	MAQ DESTROÇ-MGD-7T 2VEL C/PROT	MADER GARDEN TOOLS	1

## RACHADOR / DESTROÇADOR DE LENHA TRONZADOR DE LEÑA LOG SPLITTER



Elétrico - Monofásico  
Eléctrico - Monofásico  
Electric - Single Phase



HORIZONTAL / VERTICAL



55192



5602225551920

8 T

Ø 300 x 520 mm

Potência / Potencia / Power	3000 W
RPM	2800
Velocidades / Marchas / Gears	2
Isolamento / Aislamiento / Insulation	IP 54



Óleo Hidráulico (não incluído)  
Aceite Hidráulico (no incluido)  
Hydraulic Oil (not included)

Telex E46 - Ref. 25213 - 5 L

N. Ref.	Descrição	Marca	Quant. Caixa
55192	MAQ DESTR/DESC-MGD-8T 2V 2EM1	MADER GARDEN TOOLS	1/1

## RACHADOR / DESTROÇADOR DE LENHA TRONZADOR DE LEÑA LOG SPLITTER

Elétrico - Monofásico  
Eléctrico - Monofásico  
Electric - Single Phase



3 IN 1  
Vertical  
Horizontal  
Diagonal (45°)



55193



5602225551937

10 T

Ø300x520 mm

Potência / Potencia / Power	3000 W
Velocidades / Marchas / Gears	2
RPM	2800
Depósito Óleo / Depósito De Aceite / Oil Deposit	5 L (Telex E-46)
Isolamento / Aislamiento / Insulation	IP54
Medidas / Measures	748 x 453 x 107 mm



Óleo Hidráulico (não incluído)  
Aceite Hidráulico (no incluido)  
Hydraulic Oil (not included)

Telex E46 - Ref. 25213 - 5 L

N. Ref.	Descrição	Marca	Quant. Caixa
55193	MAQ DESTR/DESC-MGD-10T 2V 3P E	MADER GARDEN TOOLS	1/1

## RACHADOR / DESTROÇADOR DE LENHA TRONZADOR DE LEÑA LOG SPLITTER



**3 IN 1**  
Vertical  
Horizontal  
Diagonal (45°)



55156



560222551562

**12 T**  
Ø300x520 mm

Ciclo de Trabalho / Ciclo de Trabajo / Duty Cycle	29 s
Potência / Potencia / Power	3000 W
RPM	2800
Depósito Óleo / Depósito De Aceite / Oil Deposit	5 L (Telex E-46)
Pressão Max / Presión Máx / Pressure Max	3000 psi
Ruído / Noise	88 dB(A)
Isolamento / Aislamiento / Insulation	IP54
Medidas / Measures	880 x 420 x 980 mm

**Elétrico - Monofásico**  
Eléctrico - Monofásico  
Electric - Single Phase



**Óleo Hidráulico (não incluído)**  
Aceite Hidráulico (no incluido)  
Hydraulic Oil (not included)

**Telex E46 - Recom. ref. 25213 - 5 L**

N. Ref.	Descrição	Marca	Quant. Caixa
55156	MAQ DESTROÇ/DESC-MGD-12T 3EM1	MADER GARDEN TOOLS	1

## RACHADOR / DESTROÇADOR DE LENHA TRONZADOR DE LEÑA LOG SPLITTER



**3 IN 1**  
Vertical  
Horizontal  
Diagonal (45°)



55194



560222551944

**10 T**  
Ø300x520 mm

Cilindrada / Desplazamiento / Cylinder Capacity	208 cc
Potência / Potencia / Power	7 HP
Velocidades / Marchas / Gears	2 - P-Rápida / P1-Lenta
RPM	3600
Cárter / Crankcase	(10W40 / SAE30)
Depósito Óleo / Depósito De Aceite / Oil Deposit	4.2 L (Telex E-46)
Pressão Max / Presión Máx / Pressure Max	3500 psi

**4T - Gasolina 95**  
4S - Gasoline 95

**Óleo (não incluído)**  
Aceite (no incluido)  
Oil (not included)

**10W40 - Ref. 25203 - 1 L**



**Óleo Hidráulico (não incluído)**  
Aceite Hidráulico (no incluido)  
Hydraulic Oil (not included)

**Telex E46 - Ref. 25213 - 5 L**

N. Ref.	Descrição	Marca	Quant. Caixa
55194	MAQ DESTR/DESC-MGD-10T 2V 3P G	MADER GARDEN TOOLS	1/1

## RACHADOR / DESTROÇADOR DE LENHA TRONZADOR DE LEÑA LOG SPLITTER

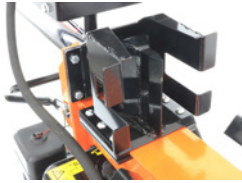

**3 IN 1**  
Vertical  
Horizontal  
Diagonal (45°)

**2 Velocidades**  
2 Speeds



55187



5602225551876

**15 T**  
Ø300x520 mm

<b>Ciclo de Trabalho</b> / Ciclo de Trabajo / Duty Cycle	<b>16 s</b>
<b>Cilindrada</b> / Desplazamiento / Cylinder Capacity	<b>196 cc</b>
<b>Potência</b> / Potencia / Power	<b>7 HP</b>
<b>Velocidades</b> / Marchas / Gears	<b>2</b>
<b>RPM</b>	<b>3600</b>
<b>Cárter</b> / Crankcase	<b>(10W40 / SAE30)</b>
<b>Depósito Óleo</b> / Depósito De Aceite / Oil Deposit	<b>5 L (Telex E-46)</b>
<b>Pressão Max</b> / Presión Máx / Pressure Max	<b>3500 psi</b>
<b>Ruído</b> / Noise	<b>100dB(A)</b>
<b>Medidas</b> / Measures	<b>880 x 420 x 980 mm</b>

N. Ref.	Descrição	Marca	Quant. Caixa
55187	MAQ DESTR/DESC-MGD-15T 3EM1 2V	MADER GARDEN TOOLS	1/1

**4T - Gasolina 95**  
**4S - Gasoline 95**

## RACHADOR / DESTROÇADOR DE LENHA TRONZADOR DE LEÑA LOG SPLITTER



**Óleo (não incluído)**  
Aceite (no incluido)  
Oil (not included)

**10W40 - Ref. 25203 - 1 L**



55188



5602225551883

**15 T**  
Ø300x520 mm

<b>Ciclo de Trabalho</b> / Ciclo de Trabajo / Duty Cycle	<b>16 s</b>
<b>Cilindrada</b> / Desplazamiento / Cylinder Capacity	<b>196 cc</b>
<b>Potência</b> / Potencia / Power	<b>6.5 HP</b>
<b>Velocidades</b> / Marchas / Gears	<b>2 - P-Rápida / P1-Lenta</b>
<b>RPM</b>	<b>3600</b>
<b>Cárter</b> / Crankcase	<b>(10W40 / SAE30)</b>
<b>Depósito Óleo</b> / Depósito De Aceite / Oil Deposit	<b>5 L (Telex E-46)</b>
<b>Pressão Max</b> / Presión Máx / Pressure Max	<b>3500 psi</b>
<b>Ruído</b> / Noise	<b>100dB(A)</b>

N. Ref.	Descrição	Marca	Quant. Caixa
55188	MAQ DESTR/DESC-MGD-15T 2V 3EM1	MADER GARDEN TOOLS	1/1



**Óleo Hidráulico (não incluído)**  
Aceite Hidráulico (no incluido)  
Hydraulic Oil (not included)

**Telex E46 - Ref. 25213 - 5 L**

**RACHADOR / DESTROÇADOR DE LENHA**  
**TRONZADOR DE LEÑA**  
**LOG SPLITTER**

**3 IN 1**  
**Vertical**  
**Horizontal**  
**Diagonal (45°)**



**2 VELOCIDADES**

2 MARCHAS

2 GEARS



55190



5602225551906

**20 T**

Ø300x520 mm

<b>Ciclo de Trabalho</b> / Ciclo de Trabajo / Duty Cycle	<b>12 s</b>
<b>Cilindrada</b> / Desplazamiento / Cylinder Capacity	<b>208 cc</b>
<b>Potência</b> / Potencia / Power	<b>7 HP</b>
<b>Velocidades</b> / Marchas / Gears	<b>2</b>
<b>RPM</b>	<b>3600</b>
<b>Cárter</b> / Crankcase	<b>(10W40 / SAE30)</b>
<b>Depósito Óleo</b> / Depósito De Aceite / Oil Deposit	<b>8 L (Telex E-46)</b>
<b>Pressão Max</b> / Presión Máx / Pressure Max	<b>3500 psi</b>
<b>Ruído</b> / Noise	<b>110dB(Lwa)</b>
<b>Medidas</b> / Measures	<b>830 x 480 x 1150 mm</b>

N. Ref.	Descrição	Marca	Quant. Caixa
55190	MAQ DESTR/DESC-MGD-20T 3EM1	MADER GARDEN TOOLS	1/1



**4T - Gasolina 95**  
**4S - Gasoline 95**

**Óleo (não incluído)**  
 Aceite (no incluido)  
 Oil (not included)

**10W40 - Ref. 25203 - 1 L**

**Óleo Hidráulico (não incluído)**  
 Aceite Hidráulico (no incluido)  
 Hydraulic Oil (not included)

**Telex E46 - Ref. 25213 - 5 L**

## RACHADOR / DESTROÇADOR DE LENHA TRONZADOR DE LEÑA LOG SPLITTER

### 2 VELOCIDADES

2 MARCHAS

2 GEARS

**2 IN 1**  
**Vertical**  
**Horizontal**



### ENGATE DE REBOQUE ENGANCHE DE REMOLQUE TOW HITCH



**27 T**  
Ø400x520 mm

Ciclo de Trabalho / Ciclo de Trabajo / Duty Cycle	15 s
Cilindrada / Desplazamiento / Cylinder Capacity	212 cc
Potência / Potencia / Power	7 HP
Velocidades / Marchas / Gears	2 - P-Rápida / P1-Lenta
RPM	3600
Cárter / Crankcase	(10W40 / SAE30)
Depósito Óleo / Depósito De Aceite / Oil Deposit	15 L (Telex E-46)
Pressão Max / Presión Máx / Pressure Max	3500 psi
Ruído / Noise	100 dB(A)
Velocidade / Velocidad / Speed	50 km/h (max.) Reboque

N. Ref.	Descrição	Marca	Quant. Caixa
55189	MAQ DESTR/DESC-MGD-27TON 2VEL	MADER GARDEN TOOLS	1/1

**4T - Gasolina 95**  
4S - Gasoline 95

**Óleo (não incluído)**  
Aceite (no incluido)  
Oil (not included)

**10W40 - Ref. 25203 - 1 L**

**Óleo Hidráulico (não incluído)**  
Aceite Hidráulico (no incluido)  
Hydraulic Oil (not included)

**Telex E46 - Ref. 25213 - 5 L**





**2 IN 1**  
**Vertical**  
**Horizontal**

**RACHADOR / DESTROÇADOR DE LENHA**  
**TRONZADOR DE LEÑA**  
**LOG SPLITTER**

**Engate de Reboque**  
Enganche de Remolque  
Tow Hitch

**70 km/h (max.)**



55169



5602225551692

**24 T**  
**Ø400x610 mm**

<b>Ciclo de Trabalho</b> / Ciclo de Trabajo / Duty Cycle	<b>15 s</b>
<b>Cilindrada</b> / Desplazamiento / Cylinder Capacity	<b>196 cc</b>
<b>Potência</b> / Potencia / Power	<b>6.5 HP</b>
<b>RPM</b>	<b>3600</b>
<b>Cárter</b> / Crankcase	<b>(10W40 / SAE30)</b>
<b>Depósito Óleo</b> / Depósito De Aceite / Oil Deposit	<b>18 L (Telex E-46)</b>
<b>Pressão Max</b> / Presión Máx / Pressure Max	<b>3500 psi</b>
<b>Ruído</b> / Noise	<b>110 dB(A)</b>
<b>Medidas</b> / Measures	<b>650 x 2120 x 520 mm</b>

N. Ref.	Descrição	Marca	Quant. Caixa
55169	MAQ DESTROÇ/DESCAS-MGD-24TON	MADER GARDEN TOOLS	1

**4T - Gasolina 95**  
**4S - Gasoline 95**

**Óleo (não incluído)**  
Aceite (no incluido)  
Oil (not included)

**10W40 - Recom. ref. 25203 - 1 L**

**Óleo Hidráulico (não incluído)**  
Aceite Hidráulico (no incluido)  
Hydraulic Oil (not included)

**Telex E46 - Recom. ref. 25213 - 5 L**



## RACHADOR / DESTROÇADOR DE LENHA TRONZADOR DE LEÑA LOG SPLITTER



## VERTICAL

**GRANDE ALCANCE / AMPLITUDE**  
GRAN ALCANCE / AMPLITUD  
LARGE REACH / AMPLITUDE

**ENGATE DE REBOQUE**  
ENGANCHE DE REMOLQUE  
TOW HITCH

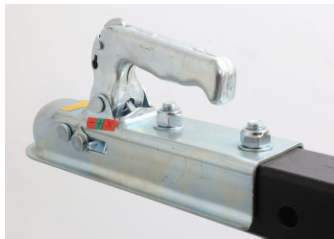

**70 km/h (max.)**



**20 T**  
Ø300x1100 mm

<b>Ciclo de Trabalho</b> / Ciclo de Trabajo / Duty Cycle	<b>10 s</b>
<b>Cilindrada</b> / Desplazamiento / Cylinder Capacity	<b>196 cc</b>
<b>Potência</b> / Potencia / Power	<b>6.5 HP</b>
<b>Cárter</b> / Crankcase	<b>(10W40 / SAE30)</b>
<b>Depósito Óleo</b> / Depósito De Aceite / Oil Deposit	<b>23.5 L (Telex E-46)</b>
<b>Pressão Max</b> / Presión Máx / Pressure Max	<b>3500 psi</b>
<b>Ruído</b> / Noise	<b>103 dB(A)</b>
<b>Medidas</b> / Measures	<b>1320 x 1248 x 3075 mm</b>

N. Ref.	Descrição	Marca	Quant. Caixa
55183	MAQ DESTROÇ/DESCA-MGD-20T VERT	MADER GARDEN TOOLS	1/1

**4T - Gasolina 95**  
4S - Gasoline 95

**Óleo (não incluído)**  
Aceite (no incluido)  
Oil (not included)

**10W40 - Ref. 25203 - 1 L**

**Óleo Hidráulico (não incluído)**  
Aceite Hidráulico (no incluido)  
Hydraulic Oil (not included)

**Telex E46 - Ref. 25213 - 5 L**



**RACHADOR / DESTROÇADOR DE LENHA**  
**TRONZADOR DE LEÑA**  
**LOG SPLITTER**



**VERTICAL**



**ENGATE DE REBOQUE**  
**ENGANCHE DE REMOLQUE**  
**TOW HITCH**

**70 km/h (max.)**

**O artigo apenas trabalha na posição vertical. A posição horizontal é apenas utilizada para transporte.**  
 Los productos solo trabajan en la posición vertical. La posición horizontal es solo en el transporte.  
 The product only works at the vertical position. For transportation use the horizontal position.

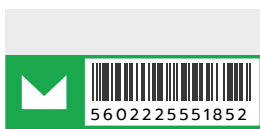

**35 T**  
 Ø350x620 mm

<b>Ciclo de Trabalho</b> / Ciclo de Trabajo / Duty Cycle	<b>13,5 s</b>
<b>Cilindrada</b> / Desplazamiento / Cylinder Capacity	<b>302 cc</b>
<b>Potência</b> / Potencia / Power	<b>10 HP</b>
<b>Cárter</b> / Crankcase	<b>(10W40 / SAE30)</b>
<b>Depósito Óleo</b> / Depósito De Aceite / Oil Deposit	<b>25 L (Telex E-46)</b>
<b>Pressão Max</b> / Presión Máx / Pressure Max	<b>3540 psi</b>
<b>Ruído</b> / Noise	<b>103 dB(A)</b>
<b>Medidas</b> / Measures	<b>1704 x 1266 x 2378 mm</b>

N. Ref.	Descrição	Marca	Quant. Caixa
55185	MAQ DESTROÇ/DESCA-MGD-35T VERT	MADER GARDEN TOOLS	1/1



**4T - Gasolina 95**  
 4S - Gasoline 95

**Óleo (não incluído)**  
 Aceite (no incluido)  
 Oil (not included)

**10W40 - Ref. 25203 - 1 L**

**Óleo Hidráulico (não incluído)**  
 Aceite Hidráulico (no incluido)  
 Hydraulic Oil (not included)

**Telex E46 - Ref. 25213 - 5 L**

**BROCA PARA RACHAR LENHA**  
**BROCA DE ASTILLADO**  
**FIREWOOD DRILL**

**Tipo FUSO**  
**Tipo HUSO**  
**SPINDLE Type**

Broca | Broca | Drill:

1 un

Adaptador | Adaptador | Adapter:

3 un

**Adaptadores Encaixe Rápido**

Adaptadores Encaje Rápido

Quick Fitting Adapters

**SDS**

**SEXTAVADA | HEXAGONAL | HEX - 8.5 mm**

**QUADRADO | CUADRADO | SQUARE - 9.5 mm**

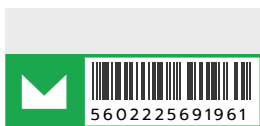

N. Ref.	Descrição	Marca	Quant. Caixa
69196	BROCA P/RACHAR LENHA-MGD-4UN	MADER GARDEN TOOLS	25

Berbequim | Taladro | Drill  
 Martelo Eléctrico | Martillo Eléctrico | Electric Hammer

**ESTRUTURA » CORTE DE LENHA**  
**ESTRUCTURA » TRONZAR LEÑA**  
**STRUCTURE » LOG CUTTING**

**COM SUPORTE PARA MOTOSSERRA - ELETROSSERRA**  
**CON SOPORTE PARA MOTOSIERRA - ELECTROSSIERRA**  
**WITH STAND FOR CHAIN SAW - ELECTRIC CHAIN SAW**



**UNIVERSAL**

<b>Medidas / Measures</b>	<b>760 » 800 mm</b>
<b>Extensão / Extensión / Extension</b>	<b>0 » 500 mm</b>

N. Ref.	Descrição	Marca	Quant. Caixa
69215	CAVALETE-MGD-P/CORTE LENHA	MADER GARDEN TOOLS	1/1



**SUPORE PARA LENHA**  
**SOPORTE PARA LEÑA**  
**WOOD RACK**

**Ferro**  
**Hierro**  
**Iron**

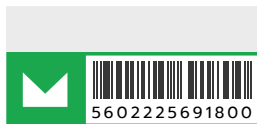

Medidas / Measures	1300 x 1300 x 300 mm
Tubo / Working Pole	Ø 30 mm
Capacidade / Capacidad / Capacity	

N. Ref.	Descrição	Marca	Quant. Caixa
69180	SUPORE-MGD-P/LENHA	MADER GARDEN TOOLS	1

**CARRO PARA LENHA**  
**CARRETILLA DE LEÑA**  
**FIREWOOD CART**

- 2 - pneumáticas:  
10" / 3.5" - 4
- 2 - neumáticas:  
10" / 3.5" - 4
- 2 - pneumatic  
10" / 3.5" - 4



**100Kg**

**530 x 520 x 1060 mm**

**Largura mínima do tronco: 33cm**  
**Anchura mínima del tronco: 33 cm**  
**Minimum log width: 33cm**



N. Ref.	Descrição	Marca	Quant. Caixa
69181	CARRO-MGD-P/LENHA	MADER GARDEN TOOLS	1

**TRITURADOR AGRÍCOLA**  
TRITURADOR AGRÍCOLA  
CHIPPER SHREDDER

**FOLHAS E RAMOS**  
HOJAS Y RAMAS  
LEAVES AND BRANCHES

**Lâminas Gêmeas Reversíveis**  
Hojas Gemelas Reversibles  
Reversible Twin Blades

**Saída Elevada e Direcional**  
Salida Elevada y Direccional  
Elevated and Directional Output



**196cc**  
Ø 100mm

<b>Potência / Potencia / Power</b>	<b>6.5hp</b>
<b>RPM</b>	<b>2400</b>
<b>Depósito Combustível / Depósito Combustible / Fuel Tank</b>	<b>3.6L</b>
<b>Cárter / Crankcase</b>	<b>0.5L (10W40 / 15W40 / SAE30)</b>
<b>Arranque / Start System</b>	<b>Manual</b>
<b>Capacidade / Capacidad / Capacity</b>	<b>3 a 5 m<sup>3</sup>/h</b>
<b>Roda / Rueda / Wheel</b>	<b>2 - (4.10 / 3.5-4)</b>
<b>Ruído / Noise</b>	<b>111db(A)</b>



**4T - Gasolina 95**  
4S - Gasoline 95

**Óleo (não incluído)**  
Aceite (no incluido)  
Oil (not included)

**10W40 - Recom. ref. 25203**

**Sistema de Paragem de Emergência**  
Sistema de Parada de Emergencia  
Emergency Stop System

**Caixa Madeira**  
Caja Madera  
Wood Box

N. Ref.	Descrição	Marca	Quant. Caixa
69361	TRITURADOR AGRICOLA-MGD-6.5HP	MADER GARDEN TOOLS	1

**TRITURADOR AGRÍCOLA**  
TRITURADOR AGRÍCOLA  
CHIPPER SHREDDER

**FOLHAS E RAMOS**  
HOJAS Y RAMAS  
LEAVES AND BRANCHES

**SAÍDA ELEVADA E DIRECIONAL**  
SALIDA ELEVADA Y DIRECCIONAL  
ELEVATED AND DIRECTIONAL  
OUTPUT



**2 Lâminas**  
2 Hojas  
2 Blades



55195



560222551951

**212cc**  
Ø 60mm

<b>Potência / Potencia / Power</b>	<b>7 hp</b>
<b>RPM</b>	<b>3600</b>
<b>Depósito Combustível / Depósito Combustible / Fuel Tank</b>	<b>3.6L</b>
<b>Cárter / Crankcase</b>	<b>0.6L (10W40 / 15W40 / SAE30)</b>
<b>Arranque / Start System</b>	<b>Manual</b>

**4T - Gasolina 95**  
4S - Gasoline 95

**Óleo (não incluído)**  
Aceite (no incluido)  
Oil (not included)



**10W40 - Ref. 25203**

N. Ref.	Descrição	Marca	Quant. Caixa
55195	TRITURAD AGRICOLA-MGD-7HP 60MM	MADER GARDEN TOOLS	1/1

**TRITURADOR AGRÍCOLA**  
TRITURADOR AGRÍCOLA  
CHIPPER SHREDDER

**FOLHAS E RAMOS**  
HOJAS Y RAMAS  
LEAVES AND BRANCHES

### Manual



**SAÍDA ELEVADA E DIRECIONAL**  
SALIDA ELEVADA Y DIRECCIONAL  
ELEVATED AND DIRECTIONAL  
OUTPUT

**Lâminas Gêmeas Reversíveis**  
Hojas Gemelas Reversibles  
Reversible Twin Blades



**212cc**  
Ø 100mm

<b>Potência / Potencia / Power</b>	<b>4.3 kW - 7 hp</b>
<b>RPM</b>	<b>3600</b>
<b>Refrigerado a Ar / Refrigerado al Aire / Air Cooled</b>	<b>Sim</b>
<b>Depósito Combustível / Depósito Combustible / Fuel Tank</b>	<b>3.6L</b>
<b>Cárter / Crankcase</b>	<b>0.6L (10W40 /15W40 /SAE30)</b>

N. Ref.	Descrição	Marca	Quant. Caixa
69364	TRITURADOR AGRICOLA-MGD-7HP	MADER GARDEN TOOLS	1/1

**4T - Gasolina 95**  
4S - Gasoline 95

**Óleo (não incluído)**  
Aceite (no incluido)  
Oil (not included)

**10W40 - Ref. 25203**

**RODA PNEUMÁTICA**  
RUEDA NEUMÁTICA  
PNEUMATIC WHEEL



**SISTEMA DE PARAGEM DE EMERGÊNCIA**  
SISTEMA DE PARADA DE EMERGENCIA  
EMERGENCY STOP SYSTEM

**TRITURADOR AGRÍCOLA**  
TRITURADOR AGRÍCOLA  
CHIPPER SHREDDER

**FOLHAS E RAMOS**  
HOJAS Y RAMAS  
LEAVES AND BRANCHES

**MARTELOS + LÂMINAS**  
MARTILLOS + HOJAS  
HAMMERS + BLADES

**Elétrico + Manual**  
Eléctrico + Manual  
Electric + Manual

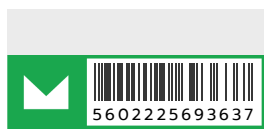

**420 cc**  
Ø 102mm



**4T - Gasolina 95**  
4S - Gasoline 95

**Óleo (não incluído)**  
Aceite (no included)  
Oil (not included)

**10W40 - Recom. ref. 25203**

**Lâminas Gêmeas Reversíveis (entrada Lateral)**  
**Martelos (entrada da cuba)**  
Hojas gemelas reversibles (entrada lateral)  
Martillos (entrada de la cuba)  
Reversible Twin Blades (Side entry)  
Hammers (vat inlet)

**Caixa Madeira**  
Caja Madera  
Wood Box

<b>Potência / Potencia / Power</b>	<b>15 hp</b>
<b>RPM</b>	<b>2400</b>
<b>Refrigerado a Ar / Refrigerado al Aire / Air Cooled</b>	<b>Sim</b>
<b>Depósito Combustível / Depósito Combustible / Fuel Tank</b>	<b>6.5 L</b>
<b>Cárter / Crankcase</b>	<b>1.1L (10W40 / 15W40 / SAE30)</b>
<b>Capacidade / Capacidad / Capacity</b>	<b>3 m3/h</b>
<b>Roda / Rueda / Wheel</b>	<b>2x - (4.10 / 3.5-4)</b>
<b>Ruído / Noise</b>	<b>116db(A)</b>

N. Ref.	Descrição	Marca	Quant. Caixa
69363	TRITUR AGRIC-MGD-15HP AE C/MAR	MADER GARDEN TOOLS	1

## TRITURADOR AGRÍCOLA TRITURADOR AGRÍCOLA CHIPPER SHREDDER

**Manual / Eléctrico**  
Manual / Eléctrico  
Manual / Electric

**FOLHAS E RAMOS**  
HOJAS Y RAMAS  
LEAVES AND BRANCHES

**Engate de Reboque**  
Enganche de Remolque  
Tow Hitch

**Lâminas Gémeas Reversíveis**  
Hojas Gemelas Reversibles  
Reversible Twin Blades

**Saída Elevada e Direcional**  
Salida Elevada y Direccional  
Elevated and Directional Output



**4T - Gasolina 95**  
4S - Gasoline 95

**Óleo (não incluído)**  
Aceite (no incluido)  
Oil (not included)



**10W40 - Recom. ref. 25203**

**Sistema de Paragem de Emergência**  
Sistema de Parada de Emergencia  
Emergency Stop System

**Caixa Madeira**  
Caja Madera  
Wood Box



**420cc**  
Ø 100mm

<b>Potência / Potencia / Power</b>	<b>15hp</b>
<b>RPM</b>	<b>2530</b>
<b>Refrigerado a Ar / Refrigerado al Aire / Air Cooled</b>	<b>Sim</b>
<b>Depósito Combustível / Depósito Combustible / Fuel Tank</b>	<b>6.5L</b>
<b>Cárter / Crankcase</b>	<b>1.1L (10W40 / 15W40 / SAE30)</b>
<b>Capacidade / Capacidad / Capacity</b>	<b>4 » 6 m3/h</b>
<b>Roda / Rueda / Wheel</b>	<b>2 - (4.10 / 3.5-4)</b>
<b>Ruído / Noise</b>	<b>112db(A)</b>

N. Ref.	Descrição	Marca	Quant. Caixa
69362	TRITURAD AGRIC-MGD-15HP ARR.E	MADER GARDEN TOOLS	1

## LÂMINA HOJA BLADE



**para Ref: 69361**  
for Ref: 69361

**para Ref: 69359**  
for Ref: 69359



**para Ref: 69361**  
for Ref: 69361

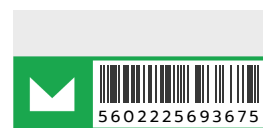
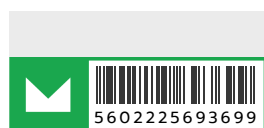

N. Ref.	Descrição	Marca	Quant. Caixa
69368	LAMINA P/ TRITURADOR 69361	MADER GARDEN TOOLS	12
69369	LAMINA P/ TRITURADOR - MGD	MADER GARDEN TOOLS	12
69367	LAMINA P/ TRITURADOR 69360	MADER GARDEN TOOLS	12



**MOINHO CEREAIS E TRITURADOR DE CAROLO**  
**MOLINO CEREALES Y TRITURADOR DE MAZORCA DE MAÍZ**  
**CRUSHING MACHINE AND CORN COB CRUSHER**

**ELÉTRICO**  
**ELÉCTRICO**  
**ELECTRIC**

**1100W**



**4** CRIVOS  
 CRIBA  
 STRAINER

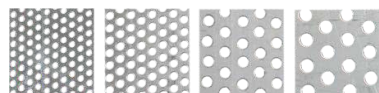

**320x305mm**

57078

<b>Potência</b> /Potencia /Power:	1100 W
<b>Produtividade</b> /Productividad /Productivity:	2850 r.p.m.
<b>Funil</b> /Tolva /Hopper:	240 Kg/h
<b>Dimensões</b> /Dimensiones/Size: :	320x305mm
<b>Peso</b> /Weight:	490 x 360 x 460 mm
	24 Kg



Descrição: Moinho / Triturador p/ Cereais

Marca: Mader Garden

N. Ref.	Especificação	Quant. Caixa:
57078	1100 W - 305 mm	1

**SUPORTE/MESA » MOINHO CEREAIS**  
**SOPORTE/MESA » MOLINO CEREALES**  
**STAND/TABLE » CRUSHING MACHINE**



**170x255mm**

Descrição: Suporte / Mesa » Moinho Cereais

Marca: Mader Garden

N. Ref.	Especificação	Quant. Caixa:
57074	p/ 57075 e 57078	1

**DEBULHADORA DE MILHO**  
**TRILHADORA DE MAÍZ**  
**THRESHER MACHINE**

**ELÉTRICO**  
**ELÉCTRICO**  
**ELECTRIC**



**750W**  
 500 Kg/h



**1100W**  
 1000 Kg/h



**57077**

**57076**

**Potência /Potencia /Power:**

750 W

1100 W

2200 r.p.m.

2200 r.p.m.

**Produtividade /Productividad /Productivity:**

500 Kg/h

1000 Kg/h

**Ruído /Noise:**

92 db(A)

92 db(A)

**Dimensões /Dimensiones/Size: :**

920 x 260 x 270 mm

740 x 280 x 320 mm

**Peso /Weight:**

15 Kg

17 Kg



**1** ESPIGA  
 ESPIGA  
 CORN EAR

**2** ESPIGAS  
 ESPIGAS  
 CORN EAR

Descrição: **Debulhadora de Milho**

Marca: **Mader Garden**

N. Ref.	Especificação	Quant. Caixa:
57077	TM-0.75 - 750W - Simple	1
57076	TM-11 - 1100W - Dupla	1

**ESMAGADOR DE FRUTA**  
MOLINO DE FRUTAS  
FRUIT CRUSHER

69670



5602225696706

**7 L**

310x335x235 mm

**Peso / Weight****12 Kg**

N. Ref.	Descrição	Marca	Quant. Caixa
69670	ESMAGADOR FRUTA-MGD-7L	MADER GARDEN TOOLS	1/1

**PRENSA PARA FRUTA**  
PRENSA DE FRUTA  
JUICE PRESS

69671



5602225696713

**12 L**

360x600 mm

**Peso / Weight****12 Kg**

N. Ref.	Descrição	Marca	Quant. Caixa
69671	PRENSA FRUTA-MGD-12L	MADER GARDEN TOOLS	1/1

**ISQUEIRO ELÉTRICO**  
**ENCENDEDOR ELÉCTRICO**  
**ELECTRIC LIGHTER**



**650°**  
**2000 W**

<b>Tensão / Tensión / Voltage</b>	<b>230V~ 50Hz</b>
<b>Cabo Alimentação / Cable Alimentación / Power Cable</b>	<b>3 m</b>
<b>Peso / Weight</b>	<b>1 kg</b>

N. Ref.	Descrição	Marca	Quant. Caixa
69114	ISQUEIRO-MGD-P/BARBECUE 2000W	MADER GARDEN TOOLS	4/4

**SOPRADOR / ASPIRADOR**  
**SOPLADOR / ASPIRADOR**  
**BLOWER / VACUUM**

**ELÉTRICO**  
**ELÉCTRICO**  
**ELECTRIC**



### ASPIRADOR



### SOPRADOR



**3000W**  
**270 Km/h**

Tensão / Tensión / Voltage	230V- 50Hz
RPM	14 000
Volume de Ar / Volumen de Aire / Air Volume	13.2 m³/min
Depósito / Deposit	35L
Ruído / Noise	100 dB

N. Ref.	Descrição	Marca	Quant. Caixa
49244	SOPRADOR/ASP-MGD-3000W QT6268	MADER GARDEN TOOLS	1



**Caixa Colorida**  
**Caja de Color**  
**Color Box**

**SOPRADOR / ASPIRADOR**  
**SOPLADOR/ASPIRADOR**  
**BLOWER / VACUUM**

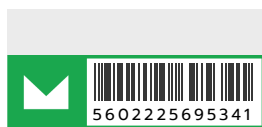

**25.4 cc**  
**270 Km/h**

<b>RPM</b>	<b>7000</b>
<b>Refrigerado a Ar / Refrigerado al Aire / Air Cooled</b>	<b>Sim</b>
<b>Arranque / Start System</b>	<b>Manual</b>
<b>Depósito Combustível / Depósito Combustible / Fuel Tank</b>	<b>650 mL</b>
<b>Fluxo de Ar / Flujo de Aire / Air Flow</b>	<b>7.8 m³/min</b>
<b>Depósito / Deposit</b>	<b>30 L</b>
<b>Ruído / Noise</b>	<b>110 dB (A)</b>
<b>Peso / Weight</b>	<b>4.6 Kg</b>



**2T - Gasolina Mix 4%**  
**2S - Gasoline Mix 4%**

**Óleo 2T - não incluído**  
**Aceite 2T - no incluido**  
**Oil 2T - not included**

**Mix 4% - Ref. 25208**

N. Ref.	Descrição	Marca	Quant. Caixa
69534	SOPRADOR/ASP-MGD-25,4CC 2T C/S	MADER GARDEN TOOLS	1/1

**SOPRADOR / ASPIRADOR**  
SOPLADOR/ASPIRADOR  
BLOWER / VACUUM

**com Triturador de Folhas**  
con Triturador de Hojas  
with Leaf Shredder



69529

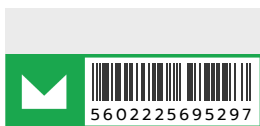

5602225695297

**25.4 cc**  
**270 Km/h**

<b>RPM</b>	<b>7500</b>
<b>Arranque / Start System</b>	<b>Manual</b>
<b>Depósito Combustível / Depósito Combustible / Fuel Tank</b>	<b>450 mL</b>
<b>Fluxo de Ar / Flujo de Aire / Air Flow</b>	<b>9 m³/min</b>
<b>Depósito / Deposit</b>	<b>40 L</b>
<b>Ruído / Noise</b>	<b>108 dB (A)</b>

N. Ref.	Descrição	Marca	Quant. Caixa
69529	SOPRADOR/ASP-MGD-25,4CC 2T	MADER GARDEN TOOLS	1/1

**O aparelho só funciona quando 100% montado, com tubos incluídos.**

El aparato sólo funciona cuando está montado al 100%, tubos incluidos.

The device only works when 100% assembled, tubes included.



**2T - Gasolina Mix 4%**  
2S - Gasoline Mix 4%

**Óleo 2T - não incluído**  
Aceite 2T - no incluido  
Oil 2T - not included

**Mix 4% - Ref. 25208**

**SOPRADOR**  
SOPLADOR  
BLOWER

**COM MOCHILA**  
CON MOCHILA  
WITH BACKPACK



**42.7 cc**  
216 Km/h



<b>RPM</b>	<b>6800</b>
<b>Arranque / Start System</b>	<b>Manual</b>
<b>Depósito Combustível / Depósito Combustible / Fuel Tank</b>	<b>1 L</b>
<b>Fluxo de Ar / Flujo de Aire / Air Flow</b>	<b>12 m³/min</b>
<b>Ruído / Noise</b>	<b>108 dB (A)</b>

N. Ref.	Descrição	Marca	Quant. Caixa
69531	SOPRADOR-MGD-42,7CC C/MOCHI 2T	MADER GARDEN TOOLS	1/1

**2T - Gasolina Mix 4%**  
2S - Gasoline Mix 4%

**Óleo 2T - não incluído**  
Aceite 2T - no incluido  
Oil 2T - not included

**Mix 4% - Ref. 25208**



**63.3 cc**  
216 Km/h



<b>RPM</b>	<b>6800</b>
<b>Arranque / Start System</b>	<b>Manual</b>
<b>Depósito Combustível / Depósito Combustible / Fuel Tank</b>	<b>1 L</b>
<b>Fluxo de Ar / Flujo de Aire / Air Flow</b>	<b>18 m³/min</b>
<b>Ruído / Noise</b>	<b>108 dB (A)</b>

N. Ref.	Descrição	Marca	Quant. Caixa
69532	SOPRADOR-MGD-63,3CC C/MOCHI 2T	MADER GARDEN TOOLS	1/1

**SOPRADOR**  
SOPLADOR  
BLOWER

**COM MOCHILA**  
CON MOCHILA  
WITH BACKPACK



**75.6 cc**  
**24 m³/min**

<b>RPM</b>	<b>7000</b>
<b>Refrigerado a Ar / Refrigerado al Aire / Air Cooled</b>	<b>Sim</b>
<b>Arranque / Start System</b>	<b>Manual</b>
<b>Depósito Combustível / Depósito Combustible / Fuel Tank</b>	<b>1.9 L</b>
<b>Ruído / Noise</b>	<b>112 dB (A)</b>

N. Ref.	Descrição	Marca	Quant. Caixa
69536	SOPRADOR-MGD-75,6CC 4T C/MOCHI	MADER GARDEN TOOLS	1/1



**4T - Gasolina**  
4S - Gasoline

**10W40 - Ref. 25203**

**Óleo (não incluído)**  
Aceite (no incluido)  
Oil (not included)

**SOPRADOR**  
SOPLADOR  
BLOWER



COM MOCHILA  
CON MOCHILA  
WITH BACKPACK



69533



56 02225 69533 4

**75.6 cc**  
**320 Km/h**



<b>RPM</b>	<b>6500</b>
<b>Arranque / Start System</b>	<b>Manual</b>
<b>Depósito Combustível / Depósito Combustible / Fuel Tank</b>	<b>1.9 L</b>
<b>Fluxo de Ar / Flujo de Aire / Air Flow</b>	<b>25,8 m³/min</b>
<b>Ruido / Noise</b>	<b>112 dB (A)</b>

**4T - Gasolina 95**  
**4S - Gasoline 95**

**220 mL (10W40 / 15W40 / SAE30)**

**ref. 25203 - Óleo 10W40**

N. Ref.	Descrição	Marca	Quant. Caixa
69533	SOPRADOR-MGD-75,6CC C/MOCHI 4T	MADER GARDEN TOOLS	1/1

**FILTRO DE AR**  
FILTRO DE AIRE  
AIR FILTER

para Soprador  
para Soplador  
for Bower

**Ref: 49239**



49340



56 02225 49340 4

N. Ref.	Descrição	Marca	Quant. Caixa
49340	FILTRO-MGD-P/SOPLADOR 49239	MADER GARDEN TOOLS	100/1

**BOMBA SUBMERSÍVEL**  
BOMBA DRENAJE  
SUBMERSIBLE PUMP

**ÁGUAS SUJAS**  
AGUAS SÚCIAS  
DIRTY WATERS



**PLÁSTICO**  
PLASTIC

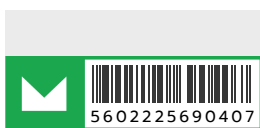

**400 W**  
8 000 L/H

Altura Max / Altura Máxima / Max Height	5 m
Profundidade Max / Profundidad Máxima / Max Depth	5 m
Cabo / Cable	10 m
	H05RN-F3Gx0.75mm2

N. Ref.	Descrição	Marca	Quant. Caixa
69040	BOMBA SUB-MGD-A.SUJAS 400W	MADER GARDEN TOOLS	1/4

Ø 1" - 1-1/4" - 1-1/2"

**Dimensão Máxima das Partículas: 25mm**

**BOMBA SUBMERSÍVEL**  
BOMBA DRENAJE  
SUBMERSIBLE PUMP

**ÁGUAS SUJAS**  
AGUAS SÚCIAS  
DIRTY WATERS

**PLÁSTICO**  
PLASTIC



**400 W**  
8000 L/h

Altura Max / Altura Máxima / Max Height	5 m
Profundidade Max / Profundidad Máxima / Max Depth	5 m
Temperatura / Temperature	35° max.
Cabo / Cable	10 m
	H05RN-F3Gx1.0mm2

N. Ref.	Descrição	Marca	Quant. Caixa
69059	BOMBA SUB-MGD-A.SUJAS 400W	MADER GARDEN TOOLS	1/4



Ø 1" - 1-1/4" - 1-1/2"

**Dimensão Máxima das Partículas: 5mm**  
Dimensión Máxima de las Partículas: 5mm  
Maximum Grain Size: 5mm

**BOMBA SUBMERSÍVEL**  
BOMBA DRENAJE  
SUBMERSIBLE PUMP

**ÁGUAS SUJAS**  
AGUAS SÚCIAS  
DIRTY WATERS

**PLÁSTICO**  
PLASTIC



**750 W**  
13 000 L/H

Altura Max / Altura Máxima / Max Height	7.5 m
Profundidade Max / Profundidad Máxima / Max Depth	5 m
Cabo / Cable	10 m
	H05RN-F3Gx0.75mm2

N. Ref.	Descrição	Marca	Quant. Caixa
69041	BOMBA SUB-MGD-A.SUJAS 750W	MADER GARDEN TOOLS	1/4

Ø 1" - 1-1/4" - 1-1/2"

**Dimensão Máxima das Partículas: 25mm**

**BOMBA SUBMERSÍVEL**  
BOMBA DRENAJE  
SUBMERSIBLE PUMP

**3 IN 1**

**ÁGUAS SUJAS / LIMPAS / ZERO ÁGUA**  
AGUA SUCIA / LIMPIA / AGUA CERO  
DIRTY / CLEAN / ZERO WATER

**Dimensão Máxima das Partículas:**  
Ø1mm, Ø8mm, Ø15mm

**Base rotativa » 3 posições**  
**Água Suja ou Água Limpa ou Sucção Zero**  
Base Giratoria » 3 posiciones  
Agua Sucia o Agua Limpia o Succión Cero

Ø 1" - 1-1/4" - 1-1/2"



**900 W**  
14 000 L/H



Altura Max / Altura Máxima / Max Height	9.5 m
Profundidade Max / Profundidad Máxima / Max Depth	7 m
Cabo / Cable	10 m
	H05RN-F3Gx0.75mm2

N. Ref.	Descrição	Marca	Quant. Caixa
69042	BOMBA SUB-MGD-3EM1 900W	MADER GARDEN TOOLS	4/1



**BOMBA SUBMERSÍVEL**  
BOMBA DRENAJE  
SUBMERSIBLE PUMP

**ÁGUAS SUJAS**  
AGUAS SÚCIAS  
DIRTY WATERS

**INOX**



**550 W**  
10 500 L/H

Altura Max / Altura Máxima / Max Height	7 m
Profundidade Max / Profundidad Máxima / Max Depth	7 m
Temperatura / Temperature	35° max.
Cabo / Cable	10 m
	H05RN-F3Gx1.0mm2

Ø 1" - 1-1/4" - 1-1/2"

Dimensão Máxima das Partículas: 5mm  
Dimensión Máxima de las Partículas: 5mm  
Maximum Grain Size: 5mm

N. Ref.	Descrição	Marca	Quant. Caixa
69057	BOMBA SUB-MGD-A.SUJAS 550W	MADER GARDEN TOOLS	4

**BOMBA SUBMERSÍVEL**  
BOMBA DRENAJE  
SUBMERSIBLE PUMP

**ÁGUAS SUJAS**  
AGUAS SÚCIAS  
DIRTY WATERS

**INOX**



**1100 W**  
18 000 L/H

Altura Max / Altura Máxima / Max Height	9.5 m
Profundidade Max / Profundidad Máxima / Max Depth	7 m
Temperatura / Temperature	35° max.
Cabo / Cable	10 m
	H05RN-F3Gx1.0mm2

Ø 1" - 1-1/4" - 1-1/2"

Dimensão Máxima das Partículas: 5mm  
Dimensión Máxima de las Partículas: 5mm  
Maximum Grain Size: 5mm

N. Ref.	Descrição	Marca	Quant. Caixa
69058	BOMBA SUB-MGD-A.SUJAS 1100W	MADER GARDEN TOOLS	4

**BOMBA SUBMERSÍVEL**  
BOMBA DRENAJE  
SUBMERSIBLE PUMP

Ø 1"

**INOX**

**ÁGUA LIMPA**  
AGUA LIMPIA  
CLEAN WATER



69043



5602225690438

**1100 W**  
6 500 L/H



69044

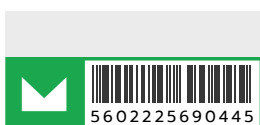

5602225690445

**1100 W**  
6 500 L/H

**AUTOMÁTICA**  
AUTOMÁTICO  
AUTOMATIC

**Multicelular - tem 4 turbinas, maior caudal e maior pressão de água (aproximadamente 4,5 bar)**  
**Equipada com um aquacessor quando falta a água,**  
- pára automaticamente após 40 segundo  
**Quando a saída de água é fechada,**  
- a bomba para automaticament  
**Quando a saída de água é aberta,**  
- a bomba liga automaticamente

**Multietapa: tiene 4 turbinas, mayor caudal y mayor presión de agua (aproximadamente 4,5 bar)**  
**Equipado con un calentador de agua cuando no hay agua,**  
- se detiene automáticamente después de 4 segundos  
**Quando la salida de agua está cerrada,**  
- la bomba se detiene automáticamente  
**Quando se abre la salida de agua,**  
- La bomba se enciende automáticamente



<b>Altura Max / Altura Máxima / Max Height</b>	<b>45 m</b>
<b>Profundidade Max / Profundidad Máxima / Max Depth</b>	<b>7 m</b>
<b>Cabo / Cable</b>	<b>10 m</b>
	<b>H07RN-F3Gx1.00mm2</b>

N. Ref.	Descrição	Marca	Quant. Caixa
69043	BOMBA SUB-MGD-MULTICELUL 1100W	MADER GARDEN TOOLS	1/1
69044	BOMBA SUB-MGD-MULTIC AUT 1100W	MADER GARDEN TOOLS	1/1



**Dimensão Máxima das Partículas: Ø3mm**

**BOMBA SUBMERSÍVEL**  
BOMBA DRENAJE SUBMERGIBLE  
SUBMERSIBLE PUMP

**INOX**



**ÁGUAS SUJAS**  
AGUAS SÚCIAS  
DIRTY WATERS

**Proteção Térmica do Motor**  
Protección Térmica del Motor  
Engine Thermal Protection



**Triturador - Turbina Aberta**  
Trituradora - Turbina Abierta  
Shredder - Open Turbine



**1100W**  
15000L/h

**1300W**  
18000L/h

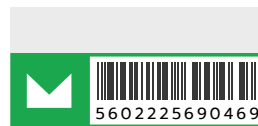

<b>Altura De Elevação</b> / Altura De Elevación / Lift Height	<b>7.5m</b>	<b>12m</b>
<b>Profundidade Max</b> / Profundidad Máxima / Max Depth	<b>7m</b>	<b>7m</b>
<b>Saída</b> / Salida / Output	<b>Ø 2"</b>	<b>Ø 2"</b>
<b>Temperatura</b> / Temperature	<b>40° MAX</b>	<b>40° MAX</b>
<b>Cabo</b> / Cable	<b>10m (H07RN-F3G0.75mm2)</b>	<b>10m (H07RN-F3G1mm2)</b>
<b>Peso</b> / Weight	<b>19Kg</b>	<b>20Kg</b>

N. Ref.	Descrição	Marca	Quant. Caixa
69045	BOMBA SUB-MGD-1100W C/TRIT INX	MADER GARDEN TOOLS	1
69046	BOMBA SUB-MGD-1300W C/TRIT INX	MADER GARDEN TOOLS	1

## ELETROBOMBA BOMBA ELÉCTRICA WATER PUMP



69064



5602225690643

**25 L/min**  
370 W - 0.5 hp

<b>Tensão / Tensión / Voltage</b>	<b>230V- 50Hz</b>
<b>Altura De Elevação / Altura De Elevación / Lift Height</b>	<b>25 m</b>
<b>Sucção / Succión / Suction</b>	<b>8m (Max.)</b>

N. Ref.	Descrição	Marca	Quant. Caixa
69064	ELETROBOMBA-MGD-370W	MADER GARDEN TOOLS	4/4



## ELETROBOMBA BOMBA ELÉCTRICA WATER PUMP

**Altura de Elevação**  
Altura de Elevación  
Lift Height

**45 m**



69065



5602225690650

**50 L/min**  
750 W - 1.0 hp

<b>Tensão / Tensión / Voltage</b>	<b>230V- 50Hz</b>
<b>Altura De Elevação / Altura De Elevación / Lift Height</b>	<b>45 m</b>
<b>Sucção / Succión / Suction</b>	<b>8m (Max.)</b>

N. Ref.	Descrição	Marca	Quant. Caixa
69065	ELETROBOMBA-MGD-JET 750W	MADER GARDEN TOOLS	1/1



## ELETROBOMBA BOMBA ELÉCTRICA WATER PUMP

COM DEPÓSITO  
CON TANQUE  
WITH TANK

**19 L**

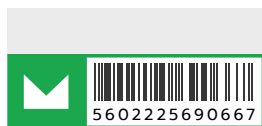

**55 L/min**  
800 W - 1.1 hp

Tensão / Tensión / Voltage	230V~ 50Hz
Altura De Elevação / Altura De Elevación / Lift Height	40 m
Sucção / Succión / Suction	8m (Max.)
Pressão / Presión / Pressure	15 bar

N. Ref.	Descrição	Marca	Quant. Caixa
69066	ELETROBOMBA-MGD-JET C/DEP 800W	MADER GARDEN TOOLS	1/1



## ELETROBOMBA BOMBA ELÉCTRICA WATER PUMP

Altura de Elevação  
Altura de Elevación  
Lift Height

**46 m**



**90 L/min**  
1100 W - 1.5 hp

Tensão / Tensión / Voltage	230V~ 50Hz
Altura De Elevação / Altura De Elevación / Lift Height	46 m
Sucção / Succión / Suction	8m (Max.)

N. Ref.	Descrição	Marca	Quant. Caixa
69067	ELETROBOMBA-MGD-MULTICEL 1100W	MADER GARDEN TOOLS	1/1



## ELETROBOMBA BOMBA ELÉCTRICA WATER PUMP

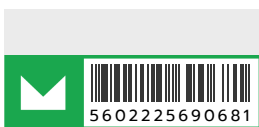

**53 L/min**  
**800 W - 1.0 hp**

<b>Tensão / Tensión / Voltage</b>	<b>230V~ 50Hz</b>
<b>Altura De Elevação / Altura De Elevación / Lift Height</b>	<b>40 m</b>
<b>Pressão Max / Presión Máx / Pressure Max</b>	<b>4 Bar</b>
<b>Temperatura / Temperature</b>	<b>35° C (máx)</b>
<b>Sucção / Succión / Suction</b>	<b>Ø 1" (25.4 mm) - 7m (Max.)</b>
<b>Saída / Salida / Output</b>	<b>Ø 1" (25.4 mm)</b>
<b>Cabo / Cable</b>	<b>1,2 m - H07RN-F 3G 1mm2</b>
<b>Ruído / Noise</b>	<b>87 dB(A)</b>



**PEGA SUPERIOR**  
MANGO SUPERIOR  
SUPERIOR HANDLE

N. Ref.	Descrição	Marca	Quant. Caixa
69068	ELETROBOMBA-MGD-800W 40M	MADER GARDEN TOOLS	1

## ELETROBOMBA BOMBA ELÉCTRICA WATER PUMP

**INOX**



**60 L/min**  
**1200 W - 1.5 hp**

<b>Tensão / Tensión / Voltage</b>	<b>230V~ 50Hz</b>
<b>Altura De Elevação / Altura De Elevación / Lift Height</b>	<b>46 m</b>
<b>Pressão Max / Presión Máx / Pressure Max</b>	<b>4.6 Bar</b>
<b>Temperatura / Temperature</b>	<b>35° C (máx)</b>
<b>Sucção / Succión / Suction</b>	<b>Ø 1" (25.4 mm) - 7m (Max.)</b>
<b>Saída / Salida / Output</b>	<b>Ø 1" (25.4 mm)</b>
<b>Cabo / Cable</b>	<b>1,2 m - H07RN-F 3G 1mm2</b>
<b>Ruído / Noise</b>	<b>87 dB(A)</b>



**PEGA SUPERIOR**  
MANGO SUPERIOR  
SUPERIOR HANDLE

N. Ref.	Descrição	Marca	Quant. Caixa
69069	ELETROBOMBA-MGD-1200W INX 46M	MADER GARDEN TOOLS	1

## MOTOBOMBA MOTOBOMBA WATER PUMP

### 1.5"

**AUTOFERRANTE**  
**AUTOCEBANTE**  
**SELF-PRIMING**



**79.6 cc**  
**17 m³/h**

<b>Potência / Potencia / Power</b>	<b>14 kW - 24 hp</b>
<b>RPM</b>	<b>3600</b>
<b>Depósito Combustível / Depósito Combustible / Fuel Tank</b>	<b>2 L</b>
<b>Sucção / Succión / Suction</b>	<b>Ø 38mm (1.5") - 7m</b>
<b>Saída / Salida / Output</b>	<b>1.5"</b>
<b>Altura De Elevação / Altura De Elevación / Lift Height</b>	<b>22 m (Max.)</b>
<b>Ruído / Noise</b>	<b>98 dB</b>

N. Ref.	Descrição	Marca	Quant. Caixa
49523	MOTOBOMBA-MGD-79.6CC-1.5" 4T	MADER GARDEN TOOLS	1



**4T - Gasolina 95**  
**4S - Gasoline 95**

## MOTOBOMBA MOTOBOMBA WATER PUMP

**AUTOFERRANTE**  
**AUTOCEBANTE**  
**SELF-PRIMING**



**97 cc**  
**14 m³/h**

<b>Potência / Potencia / Power</b>	<b>21 kW - 28 hp</b>
<b>RPM</b>	<b>3600</b>
<b>Depósito Combustível / Depósito Combustible / Fuel Tank</b>	<b>1.4 L</b>
<b>Cárter / Crankcase</b>	<b>0.5 L (10W40/15W40/SAE30)</b>
<b>Sucção / Succión / Suction</b>	<b>Ø 38mm (1.5") - 4m</b>
<b>Saída / Salida / Output</b>	<b>1.5"</b>
<b>Altura De Elevação / Altura De Elevación / Lift Height</b>	<b>20 m (Max.)</b>
<b>Ruído / Noise</b>	<b>108 dB</b>

N. Ref.	Descrição	Marca	Quant. Caixa
49520	MOTOBOMBA-MGD-2.8HP-1.5" 4T	MADER GARDEN TOOLS	1



**4T - Gasolina 95**  
**4S - Gasoline 95**



**Óleo (não incluído)**  
**Aceite (no incluido)**  
**Oil (not included)**

**10W40 - Recom. ref. 25203**

## MOTOBOMBA MOTOBOMBA WATER PUMP

**MOTOR  
EURO V**

**2"**



**196 cc**  
**36 m³/h**

<b>Potência / Potencia / Power</b>	<b>4.1 kW - 6.5 hp</b>
<b>RPM</b>	<b>3600</b>
<b>Sucção / Succión / Suction</b>	<b>Ø 50mm (2") - 7m</b>
<b>Saída / Salida / Output</b>	<b>2"</b>
<b>Altura De Elevação / Altura De Elevación / Lift Height</b>	<b>32 m (Max.)</b>

**4T - Gasolina 95**  
**4S - Gasoline 95**

**Consumo Médio Combustível - 1.2L**  
**Consumo Combustible - 1.2L**  
**Fuel Consumption - 1.2L**

N. Ref.	Descrição	Marca	Quant. Caixa
49506	MOTOBOMBA-MGD-196CC-2"	MADER GARDEN TOOLS	1

## MOTOBOMBA MOTOBOMBA WATER PUMP

**3"**



**210 cc**  
**60 m³/h**

<b>Potência / Potencia / Power</b>	<b>4.6 kW - 7 hp</b>
<b>RPM</b>	<b>3600</b>
<b>Refrigerado a Ar / Refrigerado al Aire / Air Cooled</b>	<b>Sim</b>
<b>Depósito Combustível / Depósito Combustible / Fuel Tank</b>	<b>3.5 L</b>
<b>Sucção / Succión / Suction</b>	<b>Ø 80 mm (3")</b>
<b>Saída / Salida / Output</b>	<b>3"</b>
<b>Altura De Elevação / Altura De Elevación / Lift Height</b>	<b>30 m (Max.)</b>
<b>Ruído / Noise</b>	<b>66 dB</b>

**4T - Gasolina 95**  
**4S - Gasoline 95**

N. Ref.	Descrição	Marca	Quant. Caixa
49526	MOTOBOMBA-MGD-3"/75MM 212CC	MADER GARDEN TOOLS	1/1

**MOTOBOMBA**  
MOTOBOMBA  
WATER PUMP

**POTÊNCIA**  
POTENCIA  
POWER

**2"**

**ALTA PRESSÃO**  
ALTA PRESIÓN  
HIGH PRESSURE

**GRANDE CAPACIDADE**

Pode ser usada por Bombeiros

**GRAN CAPACIDAD**

Puede ser utilizado por los bomberos.

**GREAT CAPACITY**

Can be used by firefighters

**3 Saídas** | Salidas | Output

**(2x) 1-1/2" + (1x) 2"**



**212 cc**  
**19 m³/h**



<b>Potência / Potencia / Power</b>	<b>4.6 kW</b>
<b>RPM</b>	<b>3600</b>
<b>Depósito Combustível / Depósito Combustible / Fuel Tank</b>	<b>3.6 L</b>
<b>Cárter / Crankcase</b>	<b>0.6 L</b>
	<b>(10W40 / 15W40 / SAE30)</b>
<b>Sucção / Succión / Suction</b>	<b>Ø 50mm (2") - 7m (Max.)</b>
<b>Altura De Elevação / Altura De Elevación / Lift Height</b>	<b>80m (Max.)</b>
<b>Pressão Max / Presión Máx / Pressure Max</b>	<b>0.8 MPa</b>
<b>Ruído / Noise</b>	<b>106 dB</b>



**4T - Gasolina 95**  
4S - Gasoline 95

**Óleo (não incluído)**  
Aceite (no incluido)  
Oil (not included)

**10W40 - Recom. ref. 25203**

N. Ref.	Descrição	Marca	Quant. Caixa
49524	MOTOBOMBA-MGD-212CC-2" ALTA PR	MADER GARDEN TOOLS	1

**MOTOBOMBA**  
MOTOBOMBA  
WATER PUMP

**LÍQUIDOS CORROSIVOS**  
CORROSIVE LIQUIDS

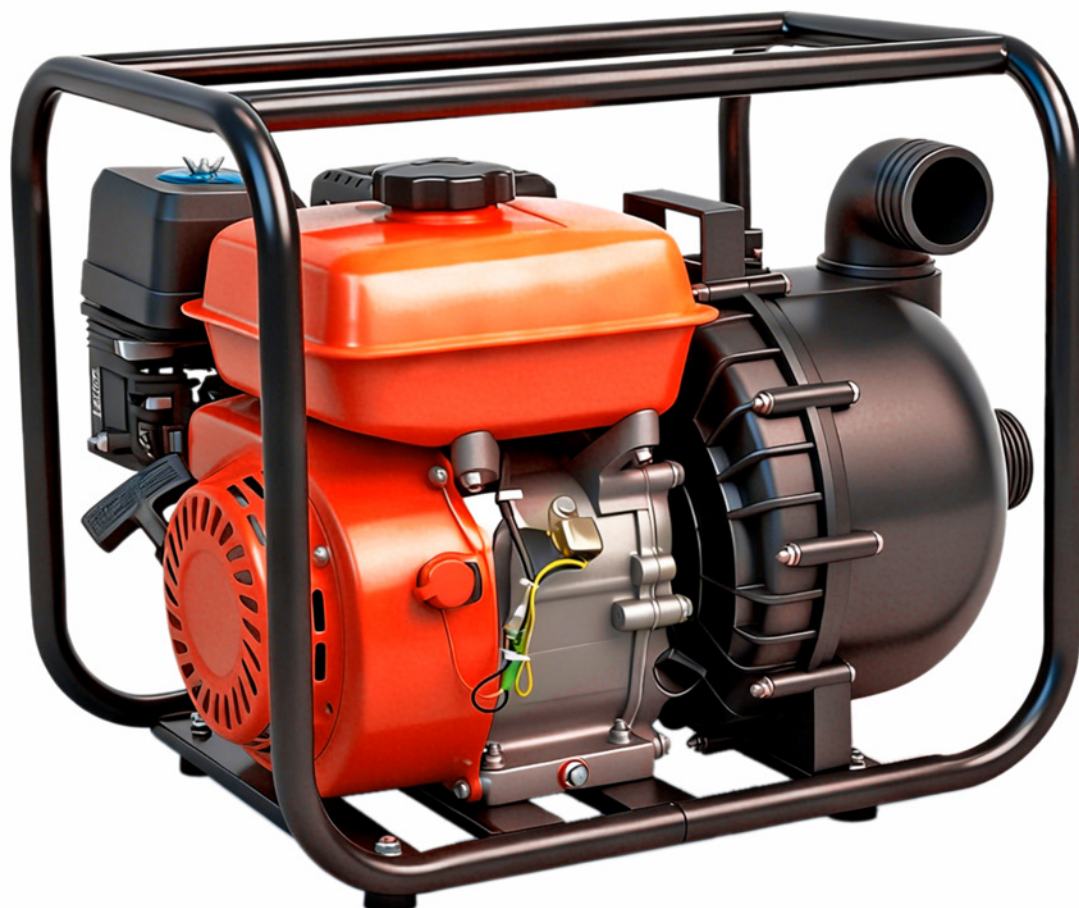

Ø 50mm (2")

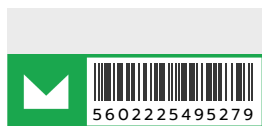

**196 cc**

**35 m³/h**

<b>Potência / Potencia / Power</b>	<b>4.7 kW</b>
<b>RPM</b>	<b>3600</b>
<b>Refrigerado a Ar / Refrigerado al Aire / Air Cooled</b>	<b>Sim</b>
<b>Depósito Combustível / Depósito Combustible / Fuel Tank</b>	<b>3.6 L</b>
<b>Cárter / Crankcase</b>	<b>0.6 L</b>
	<b>(10W40 / 15W40 / SAE30)</b>
<b>Sucção / Succión / Suction</b>	<b>7m (Max.)</b>
<b>Altura De Elevação / Altura De Elevación / Lift Height</b>	<b>30m (Max.)</b>
<b>Pressão Max / Presión Máx / Pressure Max</b>	<b>0.8 MPa</b>
<b>Ruído / Noise</b>	<b>85 dB</b>

N. Ref.	Descrição	Marca	Quant. Caixa
49527	MOTOBOMBA-MGD-2" P/LIQ CORROSI	MADER GARDEN TOOLS	1/1



**4T - Gasolina 95**  
4S - Gasoline 95

**Óleo (não incluído)**  
Aceite (no incluido)  
Oil (not included)

**10W40 - Ref. 25203**

## LIGAÇÃO CONEXIÓN CONECTOR

ALUMÍNIO  
ALUMINIUM

1"

1-1/2"



2"

3"

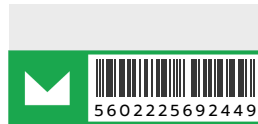

N. Ref.	Descrição	Marca	Quant. Caixa
69241	LIGAÇÃO-MGD-P/MOTOBOMBA 1"	MADER GARDEN TOOLS	1/1
69242	LIGAÇÃO-MGD-P/MOTOBOMBA 1,1/2"	MADER GARDEN TOOLS	200/200
69243	LIGAÇÃO-MGD-P/MOTOBOMBA 2"	MADER GARDEN TOOLS	100/100
69244	LIGAÇÃO-MGD-P/MOTOBOMBA 3"	MADER GARDEN TOOLS	1/50

## REDUÇÃO REDUCCIÓN REDUCTION

ALUMÍNIO  
ALUMINIUM

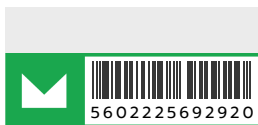

2" » 1"

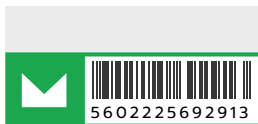

3" » 2"



N. Ref.	Descrição	Marca	Quant. Caixa
69292	LIGAÇÃO REDUT-MGD-MOTOB 2"-1"	MADER GARDEN TOOLS	100/100
69291	LIGAÇÃO REDUT-MGD-MOTOB 3"-2"	MADER GARDEN TOOLS	1/1

## MANGUEIRA SUÇÃO MANGUERA DE SUCCIÓN SUCTION HOSE

**REFORÇADA  
REFORZADA  
HEAVY-DUTY**

**para Motobomba  
for Water Pump**

**1"**

7m



**1-1/2"**

7m



**2"**

7m

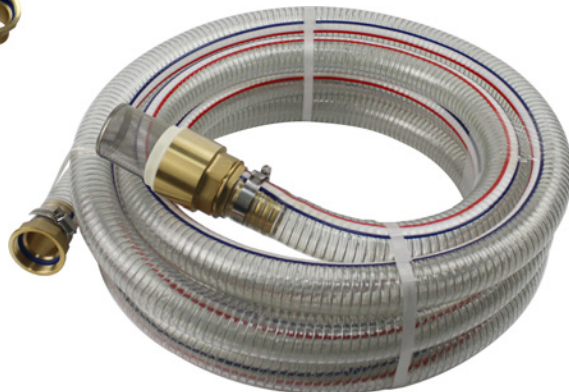

Adaptador em latão | Adaptador de latón | Brass connector:  
fêmea | hembra | female  
macho

Chupador em latão com filtro | Boquilla de filtro de latón  
| Brass one-way valve with filter  
Abraçadeira Inox | Abrazadera acero Inox  
| Stainless steel clamp

N. Ref.	Descrição	Marca	Quant. Caixa
44563	MANG SUÇÃO REF-MGD-1" 7M 6PC	MADER GARDEN TOOLS	1/5
44564	MANG SUÇÃO REF-MGD-1,5" 7M 6PC	MADER GARDEN TOOLS	4/4
44565	MANG SUÇÃO REF-MGD-2" 7M 7PC	MADER GARDEN TOOLS	1/3

## PRESSÓSTATO AUTOMÁTICO PRESOSTATO AUTOMÁTICO AUTOMATIC PRESSURE SWITCH

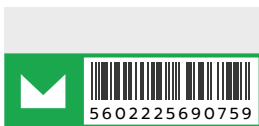

**1.5 » 10 BAR**

90°

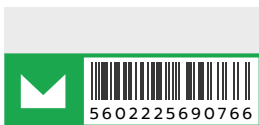

**1.5 » 10 BAR**

Vertical



<b>Manómetro / Manometer</b>	<b>10 Bar</b>
<b>Corrente (A) / Corriente / Current</b>	<b>10 A (max)</b>
<b>Classificação IP / Clasificación IP / IP Rating</b>	<b>IP65</b>
<b>Encaixe / Encaje / Fitting</b>	<b>G 1"</b>
<b>Temperatura / Temperature</b>	<b>60°C (max)</b>

N. Ref.	Descrição	Marca	Quant. Caixa
69075	PRESSÓSTAT AUT-MGD-10B R1" 90G	MADER HOME TOOLS	1/1
69076	PRESSÓSTAT AUT-MGD-10B R1" VER	MADER HOME TOOLS	1/1

**BOMBA DE ÁGUA E ELETROBOMBA  
BOMBA DE AGUA Y BOMBA ELÉCTRICA  
WATER PUMP AND ELECTRIC PUMP**

**PRESSÓSTATO**  
PRESOSTATO  
PRESSURE SWITCH

**Bomba JET**  
JET Pump



**1.4 - 2.8 Bar**



**Compatibilidade / Compatibilidad / Compatibility**      **Ref: 09321**

N. Ref.	Descrição	Marca	Quant. Caixa
49512	PRESSOSTATO-MGD-P/JET	MADER GARDEN TOOLS	1/50

**DEPÓSITO BALÃO**  
TANQUE VERTICAL  
VERTICAL TANK



**19 L**  
**1.1/4"**



N. Ref.	Descrição	Marca	Quant. Caixa
49510	DEPÓSITO BALÃO-MGD-19LT P/JET	MADER GARDEN TOOLS	1/1

**MANÓMETRO DE PRESSÃO**  
MANÓMETRO DE PRESIÓN  
PRESSURE GAUGE



**6 Bar**

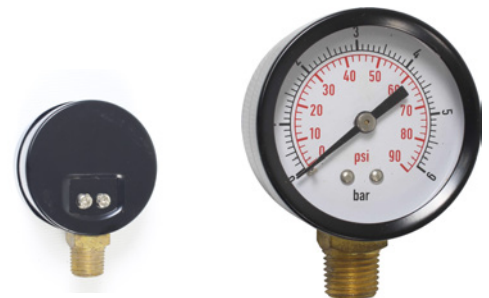

N. Ref.	Descrição	Marca	Quant. Caixa
49511	MANÓMETRO DE PRESSÃO-MGD-P/JET	MADER GARDEN TOOLS	200/200

**ADAPTADOR DE LATÃO**  
ADAPTADOR DE LATÓN  
BRASS CONECTOR



**5 VIAS**  
**TIPO T**

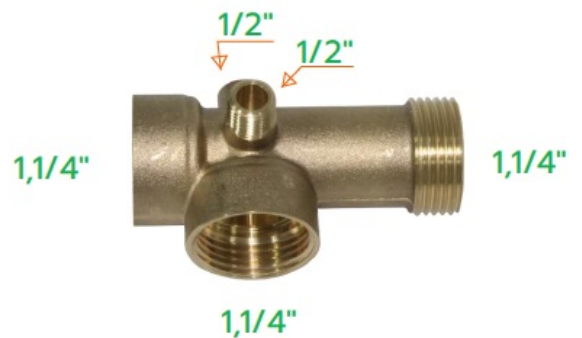

Medidas / Measures
<b>1/2" (2x)</b>
<b>1,1/4" (3x)</b>

N. Ref.	Descrição	Marca	Quant. Caixa
49513	T EM LATÃO-MGD-5 VIAS P/JET	MADER GARDEN TOOLS	1/100

**SULFATADOR**  
SULFATADOR  
MUST DUSTER



É indicado para a prevenção de doenças das plantas e controlo de pragas em grandes plantações e culturas

Está indicado para la prevención de enfermedades de las plantas y el control de plagas en grandes plantaciones y cultivos

It is indicated for the prevention of plant diseases and pest control in large plantations and crops

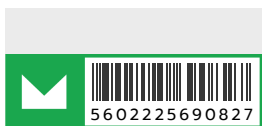

**26 L**  
415 cc

<b>Descarga / Discharge</b>	<b>Spray: 0 » 4 Kg/min</b>
<b>Comprimento / Longitud / Length</b>	<b>Pó: 0 » 6 Kg/min</b>
<b>Altura / Height</b>	<b>Pulverização: 12 m</b>
<b>RPM</b>	<b>Pulverização: 5 m</b>
<b>Potência / Potencia / Power</b>	<b>7500</b>
	<b>213 kW</b>

**2T - Gasolina Mix 4%**  
2S - Gasoline Mix 4%

**Monocilíndrico**  
Monocilíndrico  
Single Cylinder

**Óleo (não incluído)**  
Aceite (no incluido)  
Oil (not included)



**Mix 4% - Ref. 25208**

N. Ref.	Descrição	Marca	Quant. Caixa
69082	SULFATADOR-MGD-415CC 26L 2T	MADER GARDEN TOOLS	1/1

**PULVERIZADOR COM MOTOR**  
**PULVERIZADOR CON MOTOR**  
**MOTORIZED SPRAYER**

Pulverização | Pulverización | Spray:  
**8 L/min**



Mangueira | Manguera | Hose

1.2 m

Ponteira com 3 Bicos | Lanza con 3 Boquillas

| 3 Nozzle Gun

1 un

Pistola | Pistola Riego | Spray Gun

1 un



49181

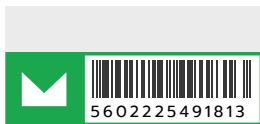

56 0222 5491813

**20 L**  
**25.6 cc**

**2T - Gasolina Mix 4%**  
**2S - Gasoline Mix 4%**

**Monocilíndrico**  
 Monocilindrico  
 Single Cylinder

**Óleo (não incluído)**  
 Aceite (no incluido)  
 Oil (not included)



**Mix 4% - Ref. 25208**

<b>Potência / Potencia / Power</b>	<b>0.7 kW</b>
<b>Refrigerado a Ar / Refrigerado al Aire / Air Cooled</b>	<b>Sim</b>

N. Ref.	Descrição	Marca	Quant. Caixa
49181	ATOMIZADOR-MGD-20LT 2T 8L/MIN	MADER GARDEN TOOLS	1/1

**MOTOR + BOMBA**  
**MOTOR + BOMBA**  
**ENGINE + PUMP**



49152



56 0222 5491523

**25.6 cc**  
**0.7 kW**

N. Ref.	Descrição	Marca	Quant. Caixa
49152	MOTOR 25.6CC 2T+BOMBA P/ATOMIZ	MADER	1/2

**PULVERIZADOR COM MOTOR**  
**PULVERIZADOR CON MOTOR**  
**MOTORIZED SPRAYER**

**Pulverização: 3-8 L/min**  
 Pulverización: 3-8 L/min  
 Spray: 3-8 L/min

**1x Mangueira: Ø8.5mm x 10m**  
**1x Pistola: Ø8.5mm x 60cm**  
**1x Ponteira com 3 Bicos**  
 1x Mangueira: Ø8.5mm x 10m  
 1x Lanza: Ø8.5mm x 60cm  
 1x Lanza con 3 Boquillas  
 1x Hose: Ø8.5mm x 10m  
 1x Spray Gun: Ø8.5mm x 60cm  
 1x 3 Nozzle Gun



**30L**  
**26cc**

**2T - Gasolina Mix 4%**  
**2S - Gasoline Mix 4%**

<b>Pressão / Presión / Pressure</b>	<b>15-25 Bar</b>
<b>Potência / Potencia / Power</b>	<b>0.75 kW</b>
<b>Refrigerado a Ar / Refrigerado al Aire / Air Cooled</b>	<b>Sim</b>

**Monocilíndrico**  
 Monocilíndrico  
 Single Cylinder

N. Ref.	Descrição	Marca	Quant. Caixa
49187	ATOMIZADOR-MGD-30LT 2T	MADER GARDEN TOOLS	1/1

**Recom.: Mix 4% - Ref. 25208**

**PULVERIZADOR COM MOTOR**  
**PULVERIZADOR CON MOTOR**  
**MOTORIZED SPRAYER**

**Pulverização: 8 L/min**  
**Pulverización: 8 L/min**  
**Spray: 8 L/min**

- 1- Mangueira: 8.5mmx30m**
- 1- Agulheta t/ Lança**
- 1- Enrolador**
- 1- Mangueira: 8.5mmx30m
- 1- Lanza Riego
- 1- Portamanguera
- 1- Hose: 8.5mmx30m
- 1- Lance Gun
- 1- Hose Reel



69085



5602225690858

**50 L**  
 25.6 cc

<b>Pressão / Presión / Pressure</b>	<b>15-25 Bar</b>
<b>Potência / Potencia / Power</b>	<b>0.7 kW</b>
<b>Refrigerado a Ar / Refrigerado al Aire / Air Cooled</b>	<b>Sim</b>

**2T - Gasolina Mix 4%**  
 2S - Gasoline Mix 4%

**Monocilíndrico**  
 Monocilíndrico  
 Single Cylinder

**Óleo (não incluído)**  
 Aceite (no incluido)  
 Oil (not included)

N. Ref.	Descrição	Marca	Quant. Caixa
69085	ATOMIZADOR-MGD-50LT 2T	MADER GARDEN TOOLS	1/1

**Recom.: Mix 4% - Ref. 25208**

**PULVERIZADOR COM MOTOR**  
**PULVERIZADOR CON MOTOR**  
**MOTORIZED SPRAYER**

**Pulverização: 8 L/min**  
**Pulverización: 8 L/min**  
**Spray: 8 L/min**

- 1- Mangueira: 8.5mmx30m
- 1- Agulheta t/ Lança
- 1- Ponteira com 3 Bicos
- 1- Pistola
- 1- Enrolador
- 1- Manguera: 8.5mmx30m
- 1- Lanza Riego
- 1- Lanza con 3 Boquillas
- 1- Pistola Riego
- 1- Portamanguera
- 1- Hose: 8.5mmx30m
- 1- Lance Gun
- 1- 3 Nozzle Gun
- 1- Hat Gun
- 1- Hose Reel



**4T - Gasolina 95**  
**4S - Gasoline 95**

**Monocilíndrico**  
**Monocilindrico**  
**Single Cylinder**

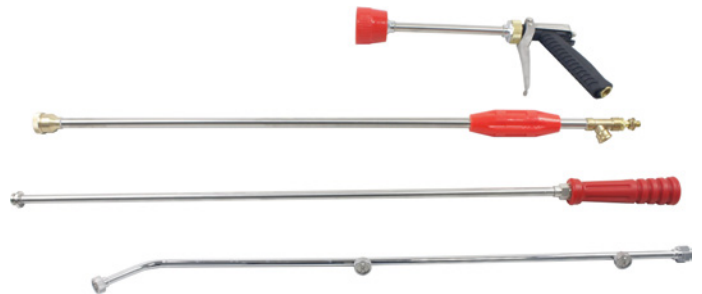

**100 L**  
**37.7 cc**

<b>Comprimento / Longitud / Length</b>	<b>Pulverização: 7 m</b>
<b>Altura / Height</b>	<b>Pulverização: 3 m</b>
<b>Potência / Potencia / Power</b>	<b>1 kW</b>
<b>Refrigerado a Ar / Refrigerado al Aire / Air Cooled</b>	<b>Sim</b>



**Óleo (não incluído)**  
**Aceite (no incluido)**  
**Oil (not included)**

**Recom.: 10W40 - Ref. 25203 - 1L**

N. Ref.	Descrição	Marca	Quant. Caixa
49182	ATOMIZADOR-MGD-100LT 4T C/30M	MADER GARDEN TOOLS	1/1

### AGULHETA LANZA GUN



49110

### PISTOLA



5602225491103



49111



5602225491110



49118



5602225491189



N. Ref.	Descrição	Marca	Quant. Caixa
49110	AGULHETA T/PISTOL P/ATOMIZADOR	MADER	1/50
49111	AGULHETA T/LANÇA P/ATOMIZADOR	MADER	5/50
49118	AGULHETA T/LANÇA P/ATOMIZ 50L	MADER	1/50

para Pulverizador com Motor  
para Pulverizador con Motor  
for Motorized Sprayer

### MANGUEIRA MANGUERA HOSE

1.2 m



49123



5602225491233



49119



5602225491196

8.5 mm x 25 m  
180 KgF/cm<sup>2</sup>



N. Ref.	Descrição	Marca	Quant. Caixa
49123	MANGUEIRA P/ATOMIZADOR 1,2M	MADER	1/1
49119	MANGUEIRA P/ATOMIZADOR 25M	MADER	5/5

para Pulverizador com Motor  
para Pulverizador con Motor  
for Motorized Sprayer



### REGADOR REGADERA WATERING CAN

4 L



CRIVO  
CRIBADO  
SIEVE



6 L



9 L



13 L



N. Ref.	Descrição	Marca	Quant. Caixa
29364	REGADOR 4L C/CRIVO	MADER GARDEN TOOLS	1/15
29363	REGADOR 6L C/CRIVO	MADER GARDEN TOOLS	1/1
29361	REGADOR 9L C/CRIVO	MADER GARDEN TOOLS	1/1
29365	REGADOR 13L C/CRIVO	MADER GARDEN TOOLS	1/4

### PULVERIZADOR PULVERIZADOR SPRAYER

500 mL

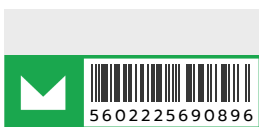

1 L



2 L

PONTEIRA EM LATÃO  
PONTERA EN LATÓN  
BRASS NOZZLE



N. Ref.	Descrição	Marca	Quant. Caixa
69089	PULVERIZADOR-MDG-500ML	MADER GARDEN TOOLS	1/1
49099	PULVERIZADOR-MGD-1L TS1000	MADER GARDEN TOOLS	1/100
49093	PULVERIZADOR-MGD-2L EP20	MADER GARDEN TOOLS	1/20

### PULVERIZADOR PULVERIZADOR HAND SPRAYER



5 L



49094



5602225490946



LANÇA EM INOX  
LANZA EN INOX  
STAINLESS STEEL LANCE

8 L



49095



5602225490953



Com alça de transporte  
Con correa de transporte  
With carrying strap

N. Ref.	Descrição	Marca	Quant. Caixa
49094	PULVERIZADOR-MGD-5L 50Q	MADER GARDEN TOOLS	1/6
49095	PULVERIZADOR-MGD-8L 80Q	MADER GARDEN TOOLS	1/6

### PULVERIZADOR PULVERIZADOR SPRAYER

REFORÇADO  
REFORZADO  
REINFORCED

LANÇA EM INOX  
LANZA EN INOX  
STAINLESS STEEL LANCE

Mochila  
Backpack



49091



5602225490915

12 L  
2 - 3 Bar



69094



5602225690940

16 L  
2 - 3 Bar



ANTITRANSPIRANTE  
ANTIPERSPIRANTE

N. Ref.	Descrição	Marca	Quant. Caixa
49091	PULVERIZADOR-MGD-12L C/VAR INX	MADER GARDEN TOOLS	1/1
69094	PULVERIZADOR-MDG-16L LANÇ INOX	MADER GARDEN TOOLS	1/1

**PULVERIZADOR**  
PULVERIZADOR  
SPRAYER

**2IN1**  
**BATERIA + MANUAL**

**Mochila**  
Backpack

**LÍTIO**  
LITIO  
LITHIUM

**LANÇA EM INOX**  
LANZA EN INOX  
STAINLESS STEEL LANCE

**PROTEÇÃO PARA COSTAS »**  
**ANTITRANSPIRANTE**  
PROTECCIÓN PARA ESPALDAS »  
ANTITRANSPIRANTE  
BACK PROTECTION »  
ANTIPERSPIRANT



**Altura a partir do bico: 2m**  
**Alcance do jato a partir do bico: 4.7m**  
**Largura do leque: 1.5m**  
Altura desde la boquilla: 2 m  
Alcance del chorro desde la boquilla: 4.7m  
Anchura del abanico: 1.5m  
Height from nozzle: 2m  
Jet range from nozzle: 4.7m  
Fan width: 1.5m



69092



5602225690926

**16 L**  
**12 V - 8 A**

**Reservatório em Polipropileno**  
Depósito de polipropileno  
Polypropylene tank

N. Ref.	Descrição	Marca	Quant. Caixa
69092	PULVERIZ-MGD-16L C/BAT LIT	MADER GARDEN TOOLS	1/1

## PULVERIZADOR PULVERIZADOR SPRAYER

### Manómetro:

Fácil de ler » Controlo preciso

### Válvula de Segurança:

Sistema de alívio de Pressão » Previne o excesso de Bombardeamento

### Pega de Apoio:

Estável quando bombeia » Ajuda a esvaziar

### Suporte Integrado:

Almofadas de pés duplas » Estabilidade extra no solo

### Manometro:

Facil de leer » Control preciso

### Valvula de Seguridad:

Sistema de alivio de presión » Previne el exceso de bombeo

### Mango de Soporte:

Estable durante el bombeo » Ayuda al vaciar

### Suporte Integrado:

Almohadillas de doble pie » Estabilidad extra el suelo

### Pressure Gauge:

Easy to read dial » Accurate control

### Safety Valve:

Pressure relief system » Prevents over pumping

### Support Handle:

Stable When Pumping » Helps when empty

### Integrated Stand:

Dual foot pads » Extra ground stability



**5 L**  
**2.5 bar**

**PRODUTOS QUÍMICOS**  
PRODUCTOS QUIMICOS  
CHEMICAL PRODUCTS

**PRESSÃO**  
PRESIÓN  
PRESSURE

**ÁREA | SUPERFÍCIE:**  
**25 - 60 M2**



N. Ref.	Descrição	Marca	Quant. Caixa
49054	PULVERIZADOR P/PROD QUÍMICO 5L	MADER GARDEN TOOLS	1/6

**8 un**

**VEDANTES DE BORRACHA**  
SELLADORES DE GOMA  
RUBBER SEALERS



**410mm**

**LANÇA COM PONTEIRA**  
LANZA CON PUNTERA  
LANCE WITH NOZZLE



**1200 mm**

**MANGUEIRA COM AGULHETA**  
MANGUERA CON LANZA  
HOSE WITH TRIGGER



**MANÓMETRO**  
MANOMETRO  
PRESSURE GAUGE

**5 bar / 70 psi**

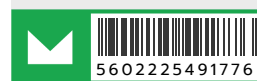

N. Ref.	Descrição	Marca	Quant. Caixa
49179	VEDANTES-MGD-P/PULV 5L 5PCS	MADER GARDEN TOOLS	1/1
49178	LANÇA C/PONTEIRA-MGD-P/PULV 5L	MADER GARDEN TOOLS	1/50
49176	MANG C/AGULHETA-MGD-P/PULV 5L	MADER GARDEN TOOLS	1/1
49177	MANÓMETRO-MGD-P/PULV 5L	MADER GARDEN TOOLS	1/1



**para Pulverizador 49054**  
for Sprayer 49054

**PULVERIZADOR**  
PULVERIZADOR  
SPRAYER

**PEÇAS DE REPOSIÇÃO**  
PIEZAS DE REPUESTO  
SPARE PARTS



**EP20 - 2 L**

**Ponteira**  
Boquilla  
Nozzle

**LATÃO**  
LATÓN  
BRASS



p/ 2L  
**2un**



**Mangueira**  
Manguera  
Hose



**50Q - 5 L**



**80Q - 8 L**

**Mangueira**  
Manguera  
Hose



p/ 8L  
**1un**



p/ 5L  
**1un**



p/ 5L - 8L  
**1un**

**Agulheta**  
Maneta  
Nozzle



p/ 5L - 8L  
**1un**

**Ponteira**  
Boquilla  
Nozzle

**Ponteira + Lança**  
Boquilla + Lanza  
Nozzle + Lance

**FIBRA VIDRO**  
FIBRA VIDRIO  
FIBER GLASS



p/ 5L - 8L  
**1un**

Descrição: Peças p/ Pulverizador » 2L / 5L / 8L

Marca: Mader Garden

N. Ref.	Especificação	Quant.	Caixa:
49124	Ponteira Latão - 2pç - Pulv. 2L	6	
49085	Ponteira Latão - 2pç - Pulv. 2L	6	
49125	Mangueira - Pulv. 5L	6	
49126	Mangueira - Pulv. 8L	6	
49127	Agulheta - Pulv. 5L/8L	6	
49128	Ponteira - 1pç - Pulv. 5L/8L	6	
49166	Pont.+Lan. Fibra Vid. - Pulv. 5L/8L	6	
49083	Ponteira + Lança - Pulv. 5L/8L	6	
49129	Lança - Pulv. 5L/8L	6	



p/ 5L - 8L  
**1un**

**Ponteira + Lança**  
Boquilla + Lanza  
Nozzle + Lance

**INOX**



p/ 5L - 8L  
**1un**

**Lança**  
Lanza  
Lance

**INOX**

## PULVERIZADOR PULVERIZADOR SPRAYER

### PEÇAS DE REPOSIÇÃO PIEZAS DE REPUESTO SPARE PARTS

**12L  
49091**



### Mangueira Manguera Hose



### Bomba Bomba Pump



PARA / TO  
49091  
66007  
69092

### Filtro Filtro Filter



### Tampa Tapón Cap



### Bico Boquilla Nozzle

**2un**



### Bico Simples Boquilla Sencilla Single Nozzle

**2un**



### Bico Duplo Boquilla Doble Double Nozzle

**2un**



### Manivela Manija Handle



**KF-12B-B**

**KF-16B-H**

### Bico Simples Boquilla Sencilla Single Nozzle

**2un**



**BICO ESPALHADOR  
ESPORÁCEO  
SPREADER SPOUT**



### Agulheta Maneta Nozzle



### Anilha Arandela Ring

**5un**



Descrição: Peças p/ Pulverizador » 12L

Marca: Mader Garden

N. Ref.	Especificação	Quant.	Caixa:
49067	Bomba	6	
49069	Filtro	6	
49071	Tampa	6	
49076	Mangueira	6	
49082	Bico - 2pç	6	
49080	Bico Simples - 2pç	6	
49081	Bico Duplo - 2pç	6	
49073	Manivela - KF-12B-B	6	
49074	Manivela - KF-16B-H	6	
49165	Bico Espalhador - 2 pç	6	
49077	Agulheta	6	
49075	Anilha - 5 pç	6	
49078	Lança Inox	6	
49079	Lança Inox Extensível	6	

### Lança Lanza Lance

**INOX**



### Lança Lanza Lance

**Extensível  
Extensible  
Extensible**

**INOX**



## PEÇAS DE REPOSIÇÃO PIEZAS DE REPUESTO SPARE PARTS

### PORCA DE FIXAÇÃO TUERCA DE FIXACIÓN FIXING NUT



2 un



49066



5602225490663



Lança  
Lanza  
Lance

FIBRA VIDRO  
FIBRA VIDRIO  
FIBER GLASS



5602225491677

56cm



5602225491684

100cm



5602225491691

150cm

Para Modelo / Para El Modelo / For Model

48521 - 16 L

N. Ref.	Descrição	Marca	Quant. Caixa
49066	PORCA DE FIXAÇÃO P/PULVERIZ 2UN	MADER GARDEN TOOLS	1/1
49167	Lança Fibra Vidro - 12L/16L	MADER GARDEN TOOLS	6
49168	Lança Fibra Vidro - 100 cm	MADER GARDEN TOOLS	6
49169	Lança Fibra Vidro - 150 cm	MADER GARDEN TOOLS	6

### PORCA DE FIXAÇÃO TUERCA DE SUJECIÓN FIXING NUT

4 un



49184

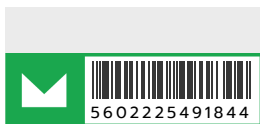

5602225491844

para Lança Extensível  
para Lanza Extensible  
for Extensible Lances

Para Modelo / Para El Modelo / For Model

49079

N. Ref.	Descrição	Marca	Quant. Caixa
49184	PORCA FIXAÇÃO P/LANÇA EXT 4P	MADER GARDEN TOOLS	1

Sistema de conexão para lanças de pulverizador  
Sistema de conexión para lanzas de pulverización  
Connection system for sprayer lances

### BICO CHUVEIRO BOQUILLA DUCHA SHOWER NOZZLE



49183

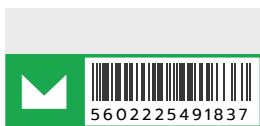

5602225491837



para PULVERIZADOR  
for SPRAYER

MADER GARDEN  
SAURIUM

N. Ref.	Descrição	Marca	Quant. Caixa
49183	BICO P/PULVERIZADOR MGD/SAL	MADER GARDEN TOOLS	20

## PULVERIZADOR PULVERIZADOR SPRAYER

## COM BATERIA CON BATERÍA WITH BATTERY

## PEÇAS DE REPOSIÇÃO PIEZAS DE REPUESTO SPARE PARTS



**Carregador**  
Cargador  
Charger

**12V-8A**

Para/to: 49051/48215/66006/66007

TN-12V  
AC 220V 50Hz  
DC 12 V  
1,0 A



**Bomba**  
Bomba  
Pump

**12v**

Para/to: 48215/66006/66007

KF-2203  
0,45 MPa  
2,9 L/min.  
DC 12 V  
1,8 A



**Bateria**  
Bateria  
Battery

**12V-8A**

Para/to: 49051/48215/66006/66007

6-DFM-8  
12V 8AH / 20HR  
13,5-13,8V (stand-by)  
14,5-14,9V (cyclic)  
2,40A max.



**Carregador**  
Cargador  
Charger

**12V-8A**

Para/to: 49174

**Bateria Lítio**  
**Bateria Lítio**  
**Battery Lithium**



Descrição: Peças p/ Pulverizador c/ Bateria » 16L

Marca: Mader Garden

N. Ref.	Especificação	Quant.	Caixa:
49159	Carregador p/ 12V-8A	1	
49160	Carregador p/ 12V-10A	10	
49161	Bomba	10	
49162	Bomba p/ 2 IN 1	10	
49163	Bateria p/ 12V-8A	10	
49164	Bateria p/ 12V-10A	30	
49175	Carregador p/ Bateria Lítio	10	
49174	Bateria Lítio p/ 12V-8A	30	

**12V-10A**

**Carregador**  
Cargador  
Charger



Para/to: 66269

TN-1210  
AC 220V 50Hz  
DC 12 V  
1,7 A



**12v**



**Bomba**  
Bomba  
Pump

Para/to: 49051/66269

KF-2203  
0,45 MPa  
2,9 L/min.  
DC 12 V  
1,8 A



**Bateria**  
Bateria  
Battery

**12V-10A**



**Bateria**  
Bateria  
Battery

Para/to: 66269

6-DFM-12,0  
12V 12AH / 20HR  
13,5-13,8V (stand-by)  
14,5-14,9V (cyclic)  
3,60A max.



**Bateria**  
Bateria  
Battery

**12V-8A**



**Bateria**  
Bateria  
Battery

Para/to: 69092

12V 8AH  
9-13V (charging)  
4 A max.



**Lítio**  
**Lítio**  
**Lithium**



**ACESSÓRIOS CLIC**  
ACCESORIOS CLIC  
CLIC ACCESSORIES

**PLÁSTICO**  
PLÁSTIC



**1/2" - União**  
200un



**1/2"**  
200un



**1/2" - Stop**  
200un



**3/4" - União**  
100un



**3/4"**  
150un



**Agulheta de Jardim /Lanza Riego**  
Adjustable Nozzle



**3/4" - Stop**  
150un



**3/4" - Fêmea**  
250un



**1" - Fêmea**  
250un



**5" - Direita**  
100un



**t/ Pistola**  
35un

Descrição: Acessório Clic p/ Mangueira - Plástico

Marca:	Mader Garden	
N. Ref.	Especificação	Quant. Caixa:
33857	1/2" - União	200
33855	1/2"	200
33853	1/2" - c/ Stop	200
33856	3/4" - União	100
33854	3/4"	150
33852	3/4" - c/ Stop	100
33850	3/4" - Fêmea	250
33851	1" - Fêmea	250
33859	5" - Agulheta Direita	100
33860	Agulheta t/ Pistola	35
33861	1/2" - Agulheta c/ Aces. - 4 un	32



**Agulheta de Jardim c/Acessórios**  
Lanza Riego c/ Accesorios  
Hose Connectors Set

**1/2"- 4 un**  
32un



### ACESSÓRIOS CLIC ACCESORIOS CLIC CLIC ACCESSORIES

### PLÁSTICO PLÁSTIC

### Agulheta de Jardim c/Acessórios Lanza Riego c/ Accesorios Hose Connectors Set



**1/2"**  
4 un

### Agulheta de Jardim c/Acessórios Lanza Riego c/ Accesorios Hose Connectors Set



**3/4"**  
5 un



**1/2"**



**1/2"**  
Stop



**1/2"**  
União



**3/4"**



**3/4"**  
Stop



**3/4"**  
União



**3/4"**  
Macho



**3/4"**  
Fêmea

Descrição: Acessório Clic p/ Mangueira - Plástico

Marca: Mader Garden

N. Ref.	Especificação	Quant. Caixa:
90473	1/2" - Agulheta c/ Aces. - 4 un	6
90505	1/2"	20
90506	1/2" - STOP	20
90507	1/2" - União	20
90472	3/4" - Agulheta c/ Aces. - 5 un	6
90508	3/4"	20
90509	3/4" - c/ Stop	20
90510	3/4" - União	20
90517	3/4" - Macho	20
90511	3/4" - Fêmea	20
90512	3/4"-1" - Fêmea	20
90516	1" - Fêmea	20
90556	3 Vias	20



**3/4"-1"**



**1"**



**3 Vias**

**ACESSÓRIOS CLIC**  
**ACCESORIOS CLIC**  
**CLIC ACCESSORIES**

**UNIVERSAL**  
**1/2" - 3/4" - 5/8"**

**PLÁSTICO**  
**PLÁSTIC**



Descrição: Acessório Clic p/ Mangueira - Universal

Marca: Mader Garden

N. Ref.	Especificação	Quant. Caixa:
90531	1/2"-3/4"-5/8" - União	20
90529	1/2"-3/4"-5/8" - Stop	20
90530	1/2"-3/4"-5/8" - Stop	20



**UNIÃO**



**STOP**

**ACESSÓRIOS CLIC**  
**ACCESORIOS CLIC**  
**CLIC ACCESSORIES**

**TPR**



**1/2"**  
**União**



**1/2"**



**1/2"**  
**Stop**



**3 VIAS**  
**VÍAS**  
**WAY**



**3/4"**  
**União**



**3/4"**



**3/4"**  
**Stop**

Descrição: Acessório Clic p/ Mangueira - TPR

Marca: Mader Garden

N. Ref.	Especificação	Quant. Caixa:
90522	1/2" - União	25/100
90518	1/2"	25/100
90519	1/2" - STOP	25/100
90526	3 Vias	25/100
90523	3/4" - União	25/100
90520	3/4"	25/100
90521	3/4" - c/ Stop	25/100

## ACESSÓRIOS CLIC ACCESORIOS CLIC CLIC ACCESSORIES



**TPR**



União / Macho



Agulheta de Jardim c/ Acessórios  
Lanza Riego c/ Accesorios  
Hose Connectors Set

**3/4"**  
4 un



Agulheta de Jardim  
Lanza Riego  
Adjustable Nozzle

**5"**



Ligação p/ Torneira / Conexión del grifo / Connection to Tap



**1/2"-3/4"**



**3/4"-1"**

**1"**

(a)



(a)



**TPR** **1"**



**1"** **ABS**  
União

Descrição: Acessório Clic p/ Mangueira - TPR

Marca: Mader Garden

N. Ref.	Especificação	Quant. Caixa:
90475	3/4" - Agulheta c/ Aces. - 4 un	25/50
90527	União - Macho	25/100
90474	5" - 125mm - Agulheta	25/100
90524	Lig. p/ Torneira - 1/2" - 3/4"	25/100
90525	Lig. p/ Torneira - 3/4" - 1"	25/100
90528	1"	25/100
90532	ABS - União - 1"	25/100
90533	ABS - Lig. p/ Torneira - 3/4"-1"	25/100

Ligação p/ Torneira  
Conexión del grifo  
Connection to Tap



(a)  
**ABS**



**3/4"-1"**



## ACESSÓRIOS CLIC ACCESORIOS CLIC CLIC ACCESSORIES



**LATÃO**  
**LATÓN**  
**BRASS**



SB3403



**3/4"**  
União



SB3401



**3/4"**



SB3402



**3/4"**  
Stop



SB3004



**3/4"**  
Macho



SB3001



**3/4"**  
Fêmea

## AGULHETA DE JARDIM /LANZA RIEGO /ADJUSTABLE NOZZLE

SB3015



SB3102



**C/ACESSÓRIOS**  
**C/ACCESORIOS**  
**HOSE CONNECTORS SET**

**1/2"**  
4 un



Descrição: Acessório Clic p/ Mangueira - Latão

Marca: Mader Garden

N. Ref.	Especificação	Quant. Caixa:
90502	3/4" - União	20
90500	3/4"	6
90501	3/4" - Stop	20
90504	3/4" - Macho	20
90503	3/4"-1" - Fêmea	20
90454	Agulheta Direita	16
90471	1/2" - Agulheta - 4pç	6

### AGULHETA DE JARDIM PISTOLA RIEGO ADJUSTABLE SPRAY GUN



**METÁLICA**

**METAL**

**METAL**



**8** Funções  
Funciones  
Features

Descrição: Agulheta de Jardim - Tipo Pistola

Marca: Mader Garden

N. Ref. Especificação Quant. Caixa:

90453 Metálica 6

90452 Metálica - 8 Funções 10

### AGULHETA DE JARDIM PISTOLA RIEGO ADJUSTABLE SPRAY GUN



**METÁLICA**

**METAL**

**METAL**



**Azul**  
Blue

**Vermelha**  
Rojo  
Red

**Amarela**  
Amarillo  
Yellow

**Verde**  
Green

Descrição: Agulheta de Jardim - Tipo Pistola

Marca: Mader Garden

N. Ref. Especificação Quant. Caixa:

41200 Metálica - Azul 12

41201 Metálica - Vermelha 12

41202 Metálica - Amarela 12

41214 Metálica - Verde 12

**AGULHETA » PISTOLA**  
LANZA RIEGO » PISTOLA  
SPRAY GUN

**AL ALLOY + TPR**



90460



56 0222 5904603

**AJUSTÁVEL**  
AJUSTABLE  
ADJUSTABLE



N. Ref.	Descrição	Marca	Quant. Caixa
90460	AGULHETA JARDIM-MGD-METAL	MADER GARDEN TOOLS	1/1

**AGULHETA » PISTOLA**  
LANZA RIEGO » PISTOLA  
SPRAY GUN

**AL ALLOY + TPR**



90461



56 0222 5904610

**8 FUNÇÕES**  
8 FUNCIONES  
8 FEATURES



N. Ref.	Descrição	Marca	Quant. Caixa
90461	AGULHETA JARDIM-MGD-8 FUNÇÕES	MADER GARDEN TOOLS	1/1

**AGULHETA » PISTOLA**  
LANZA RIEGO » PISTOLA  
SPRAY GUN

**ABS + PP + TPR**



90462



56 0222 5904627

**10 FUNÇÕES**  
10 FUNCIONES  
10 FEATURES

**com Depósito para detergente**  
con Dispensador de detergente  
with Detergent dispenser



N. Ref.	Descrição	Marca	Quant. Caixa
90462	AGULHETA JARDIM-MGD-10 FUNÇÕES	MADER GARDEN TOOLS	1/1

## AGULHETA JARDIM PISTOLA RIEGO ADJUSTABLE SPRAY GUN

ABS + PP + TPR



90463



5602225904634

6 FUNÇÕES  
6 FUNCIONES  
6 FEATURES

N. Ref.	Descrição	Marca	Quant. Caixa
90463	AGULHETA JARDIM-MGD-6 FUNÇÕES	MADER GARDEN TOOLS	1/1

EXTENSÍVEL  
EXTENSIBLE

710 » 1060 mm



180° ARTICULADA  
180° ARTICULATED



90464



5602225904641

9 FUNÇÕES  
9 FUNCIONES  
9 FEATURES

N. Ref.	Descrição	Marca	Quant. Caixa
90464	AGULHETA JARDIM-MGD-10FUNÇ EXT	MADER GARDEN TOOLS	1/1

## SISTEMA DE REGA SISTEMA DE RIEGO IRRIGATION SYSTEM

GOTA A GOTA  
GOTEO  
DROP BY DROP



Até 20 pontos de irrigação individuais.  
3 reguladores de fluxo de água de até 2 L/h.  
Para torneiras de 21mm com rosca de 26,5 mm (G3/4).  
Adaptador de parafuso para ligação a um sistema de encaixe de 13 mm (1/2") para mangueiras de jardim.  
Resistente a intempéries, aos raios UV e a temperaturas de 0 a 40 °C.

Hasta 20 puntos de riego individuales.  
3 reguladores de caudal agua de hasta 2 l/h.  
Para grifos de 21 mm con rosca de 26,5 mm (G3/4).  
Adaptador de rosca para conectar a un sistema de acoplamiento de 13 mm (1/2") para mangueras de jardín.  
Resistente a la intemperie, a los rayos UV y a temperaturas de 0 a 40 °C.



90371

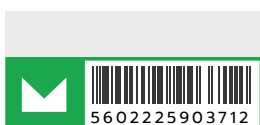

5602225903712

57 un

N. Ref.	Descrição	Marca	Quant. Caixa
90371	SISTEM REGA-MGD-GOTA/GOTA 57UN	MADER GARDEN TOOLS	1/200

**ASPERSOR DE IMPULSO**  
**ASPERSOR DE IMPULSO**  
**WATER SPRINKLER**

**Plástico**  
 Plastic

**REGULAÇÃO DO ALCANCE**  
**REGULACIÓN DE ALCANCE**  
**RANGE REGULATION**



**1/2"**

**3/4"**



**com Espigão**  
**con Enclavamiento**  
**with Spike**



N. Ref.	Descrição	Marca	Quant. Caixa
90551	ASPERSOR PL-MGD-S/ESP SB4001A	MADER GARDEN TOOLS	60/60
90553	ASPERSOR PL-MGD-C/ESP SB4503S	MADER GARDEN TOOLS	30/30

**ASPERSOR DE IMPULSO**  
**ASPERSOR DE IMPULSO**  
**WATER SPRINKLER**

**Metálico**  
 Metal

**REGULAÇÃO DO ALCANCE**  
**REGULACIÓN DE ALCANCE**  
**RANGE REGULATION**



**1/2"**

**3/4"**



**com Espigão**  
**con Enclavamiento**  
**with Spike**



N. Ref.	Descrição	Marca	Quant. Caixa
90550	ASPERSOR MET-MGD-S/ESP SB4001	MADER GARDEN TOOLS	60/60
90552	ASPERSOR MET-MGD-C/ESP SB4102	MADER GARDEN TOOLS	30/30

**ASPERSOR DE EMERGIR**  
**ASPERSOR DE EMERGER**  
**POP UP SPRINKLER**

**Plástico**  
 Plastic



**1/2"**

**25° - 360°**



**1/2"**



**1/2" + 3/4"**

**20° - 340°**

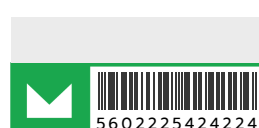

N. Ref.	Descrição	Marca	Quant. Caixa
90370	ASPERSOR EMERGIR-MGD-X-2KLN	MADER GARDEN TOOLS	200/200
42422	ASPERSOR EMERGIR-MEX-1120 GRAN	MADER GARDEN TOOLS	1/20

**REGULAÇÃO AUTOMÁTICA E SETORIAL**  
**REGULACIÓN AUTOMÁTICA Y SECTORIAL**  
**AUTOMATIC AND SECTORIAL REGULATION**

**CHUVEIRO JARDIM**  
DUCHA DE JARDÍN  
GARDEN SHOWER

**COM TRIPÉ**  
CON TRIPODE  
WITH TRIPOD

**EXTENSÍVEL | EXTENSIBLE**  
**122 » 240 CM**

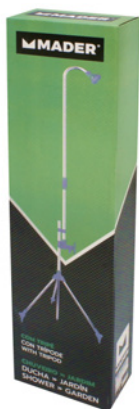

90555



5602225905556

N. Ref.	Descrição	Marca	Quant. Caixa
90555	CHUVEIRO JARDIM-MGD-C/TRIPÉ	MADER GARDEN TOOLS	10/10

**MANGUEIRA DE JARDIM**  
MANGUERA DE JARDÍN  
GARDEN HOSE

**PVC Flexível, 3 Camadas**  
PVC Flexible, 3 Capas  
Flexible PVC, 3 layers

**190 g/m<sup>2</sup>**



**1/2" 15 m 1/2" 25 m**

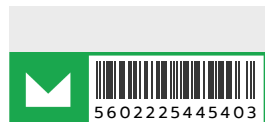

**5/8" 25 m 5/8" 50 m**

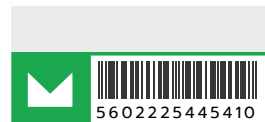

**3/4" 15 m 3/4" 25 m 3/4" 50 m**



**FIO DE POLIÉSTER DE ALTA RESISTÊNCIA ESPIRALADO**  
HILO DE POLIÉSTER DE ALTA RESISTENCIA ENROLLADO EN ESPIRAL  
SPIRAL-WOUND HIGH-STRENGTH POLYESTER YARN

**É uma mangueira leve, flexível e resistente a pressões médias que a torna adequada para rega de jardins ou para outras utilizações domésticas.**

Es una mangueira ligera, flexible y resistente a presiones medias, por lo que es adecuada para el riego de jardines u otros usos domésticos.

N. Ref.	Descrição	Marca	Quant. Caixa
44540	MANG JARD-MGD-VERDE 1/2" 15MT	MADER GARDEN TOOLS	1/1
44543	MANG JARD-MGD-VERDE 1/2" 25MT	MADER GARDEN TOOLS	1/1
44541	MANG JARD-MGD-VERDE 5/8" 25MT	MADER GARDEN TOOLS	1/1
44503	MANG JARD-MGD-VERDE 5/8" 50M	MADER GARDEN TOOLS	1/1
44549	MANG JARD-MGD-VERDE 3/4" 15MT	MADER GARDEN TOOLS	1/1
44542	MANG JARD-MGD-VERDE 3/4" 25MT	MADER GARDEN TOOLS	1/1
44505	MANG JARD-MGD-VERDE 3/4" 50M	MADER GARDEN TOOLS	1/1

**MANGUEIRA DE JARDIM**  
MANGUERA DE JARDÍN  
GARDEN HOSE

**5 un**

Acessórios  
| Accesorios | Accessories



**20 m**  
**3/4"**



N. Ref.	Descrição	Marca	Quant. Caixa
44526	KIT MANG C/ACE-MGD-VD 3/4" 20M	MADER GARDEN TOOLS	1/1

**MANGUEIRA DE JARDIM**  
MANGUERA DE JARDÍN  
GARDEN HOSE

**PVC Flexível, 3 Camadas**  
PVC Flexible, 3 Capas  
Flexible PVC, 3 layers

**210 g/m<sup>2</sup>**



**REFORÇADA**  
REFORZADO  
REINFORCED

**25 m**

5/8"



**50 m**

5/8"



**25 m**

3/4"



**50 m**

3/4"



**50 m**

1"



**DISPONIVEL EM AZUL**



**Resistente aos agentes atmosféricos**

Resistente a los agentes atmosféricos  
Resistant to atmospheric agents

**É uma mangueira flexível e resistente a pressões médias que a torna adequada para rega de jardins ou para outras utilizações domésticas.**

Es una mangueira flexible y resistente a presiones medias, por lo que es adecuada para el riego de jardines u otros usos domésticos.

It is a flexible hose that is resistant to medium pressure, making it suitable for garden irrigation or other domestic uses.

**FIO DE POLIÉSTER DE ALTA RESISTÊNCIA ESPIRALADO**

**HILO DE POLIÉSTER DE ALTA RESISTENCIA ENROLLADO EN ESPIRAL**

**SPIRAL-WOUND HIGH-STRENGTH POLYESTER YARN**

N. Ref.	Descrição	Marca	Quant. Caixa
44506	MANG JARD-MGD-AMARELA 5/8" 25M	MADER GARDEN TOOLS	1/1
44507	MANG JARD-MGD-AMARELA 5/8" 50M	MADER GARDEN TOOLS	1/1
44508	MANG JARD-MGD-AMARELA 3/4" 25M	MADER GARDEN TOOLS	1/1
44509	MANG JARD-MGD-AMARELA 3/4" 50M	MADER GARDEN TOOLS	1/1
44510	MANG JARD-MGD-AMARELA 1" 50M	MADER GARDEN TOOLS	1/1



**MANGUEIRA DE JARDIM**  
MANGUERA DE JARDÍN  
GARDEN HOSE

**PVC Flexível, 3 Camadas**  
PVC Flexible, 3 Capas  
Flexible PVC, 3 layers

**260 g/m<sup>2</sup>**



**REFORÇADA**  
REFORZADO  
REINFORCED

**25 m**  
3/4"

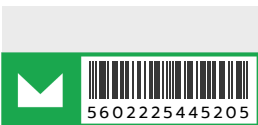

**50 m**  
3/4"



**50 m**  
1"



**Resistente aos agentes atmosféricos**  
Resistente a los agentes atmosféricos  
Resistant to atmospheric agents

**Mangueira robusta e flexível para aplicações diversas na casa, jardim e transporte de água no geral.**

Manguera robusta y flexible para diversas aplicaciones en el hogar, el jardín y el transporte de agua en general.  
Robust and flexible hose for various applications in the home, garden and general water transport.

**FIO DE POLIÉSTER TRICOTADO**  
HILO DE POLIÉSTER DE PUNTO  
KNITTED POLYESTER YARN

N. Ref.	Descrição	Marca	Quant. Caixa
44520	MANG JARD-MGD-AZUL 3/4" 25MT	MADER GARDEN TOOLS	1/1
44521	MANG JARD-MGD-AZUL 3/4" 50MT	MADER GARDEN TOOLS	1/1
44522	MANG JARD-MGD-AZUL 1" 50MT	MADER GARDEN TOOLS	1/1

**MANGUEIRA DE JARDIM**  
MANGUERA DE JARDÍN  
GARDEN HOSE

**4 un TPR**  
Acessório | Accesorios | Accessories



**20 m**  
3/4"

N. Ref.	Descrição	Marca	Quant. Caixa
44525	KIT MANG C/ACE-MGD-AZ 3/4" 20M	MADER GARDEN TOOLS	1/1

**SUPORE MANGUEIRA**  
SOPORTE MURAL MANGUEIRA  
HOSE HANGER

**Plástico**  
Plastic

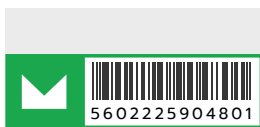

N. Ref.	Descrição	Marca	Quant. Caixa
90480	SUPORE MANG-MGD-PL ECO SB5301	MADER GARDEN TOOLS	60

**SUPORE MANGUEIRA**  
SOPORTE MURAL MANGUEIRA  
HOSE HANGER

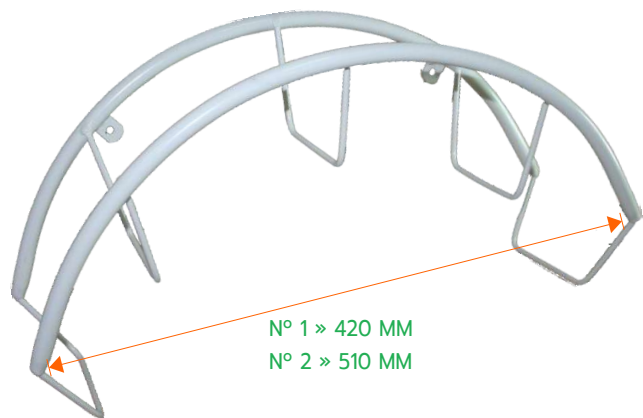

BRANCO  
BLANCO  
**METAL**

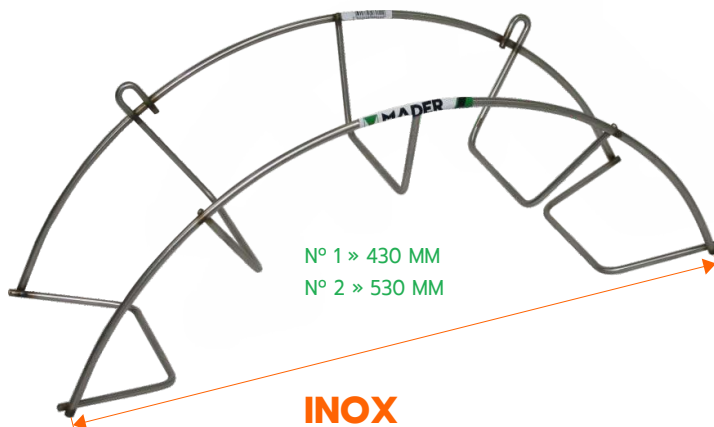

**INOX**



**nº1**  
Branco



**nº1**  
Inox

Descrição: Suporte p/ Mangueira

N. Ref.	Especificação	Quant. Caixa:
96011	Metálico - Branco - nº1	16
96012	Metálico - Branco - nº2	1
96018	Inox - nº1	16
96014	Inox - nº2	1



**nº2**  
Branco



**nº2**  
Inox

### ENROLADOR DE MANGUEIRA CARRO PORTAMANGUEIRA HOSE REEL CART



**PLÁSTICO**  
**PLÁSTIC**

Descrição: Enrolador de Mangueira

Marca: Mader Garden

N. Ref. Especificação  
90481 Plástico c/ Rodas

Quant. Caixa:  
5

**AÇO ZINCADO**  
**ACERO ZINCADO**  
**ZINC-PLATED STEEL**



Art. 210  
50 m - 1/2"  
3,75 Kg  
320x380x400 mm



**50m** 13012  
**210**

**AÇO ZINCADO**  
**ACERO ZINCADO**  
**ZINC-PLATED STEEL**

Art. 310  
80m - 1/2" \* 50m - 3/4"  
4,81 Kg  
475x350x410 mm



**50m** 13010  
**310**

**METAL**

Art. 311  
80m - 1/2" \* 50m - 3/4"  
4,85 Kg  
475x350x410 mm



**80m** 13005  
**311**

Descrição: Enrolador de Mangueira

Marca: Agrati

N. Ref. Especificação  
13012 Zincado c/ Rodas 210  
13010 Zincado c/ Rodas 310  
13005 Metálico c/ Rodas 311

Quant. Caixa:  
1  
1  
1

**ENROLADOR DE MANGUEIRA**  
**CARRO PORTAMANGUEIRA**  
**HOSE REEL CART**

**METAL**



**110m** 13007  
**316**

Art. 316  
**110 m - 1/2"**  
**80 m - 3/4"**  
 6,30 Kg.  
 495x350x490 mm



**120m** 13009  
**317**

Art. 317  
**120 m - 1/2"**  
**90 m - 3/4"**  
 8,00 Kg.  
 560x495x505 mm



**170m** 13008  
**320**

Art. 320  
**170 m - 1/2"**  
**140 m - 3/4"**  
 11,90 Kg.  
 635x525x615mm



**140m** 13006  
**410**

Art. 410  
**140 m - 1/2"**  
**110 m - 3/4"**  
 10,75 Kg.  
 635x525x615 mm



Descrição: **Enrolador de Mangueira**

Marca: **Agrati**

N. Ref.	Especificação	Quant. Caixa:
13007	Metálico c/ Rodas - 316	1
13009	Metálico c/ Rodas - 317	1
13008	Metálico c/ Rodas - 320	1
13006	Metálico c/ Rodas - 410	1

## ESTUFA DE JARDIM INVERNADER DE JARDÍN GARDEN GREENHOUSE



**Prateleiras 2 (69x49cm)**  
Estantes 2 (69x49cm)  
Shelves 2 (69x49cm)

69 x 49 x 92 cm



69165



5602225691657



- Cobertura resistente à geada.
- Porta com fecho, permite cuidar e colher facilmente.
- Estrutura de aço resistente.
- Montagem fácil sem ferramenta.



**Prateleiras 4 (69x49cm)**  
Estantes 4 (69x49cm)  
Shelves 4 (69x49cm)



69 x 49 x 158cm



69166

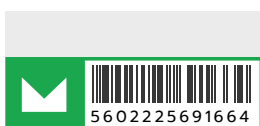

5602225691664



- Cubierta resistente a las heladas.
- Puerta con cerradura para facilitar el cuidado y la recolección.
- Robusta estructura de acero.
- Fácil montaje sin herramientas.



- Frost-resistant cover.
- Zipping door for easy care and harvesting.
- Sturdy steel frame.
- Easy assembly no tools required.

N. Ref.	Descrição	Marca	Quant. Caixa
69165	ESTUFA-MGD-69X49X92CM	MADER GARDEN TOOLS	1/1
69166	ESTUFA-MGD-69X49X158CM	MADER GARDEN TOOLS	1/1

## ESTUFA DE JARDIM INVERNADERO DE JARDÍN GARDEN GREENHOUSE

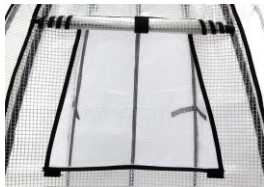

160 x 160 x 180 cm

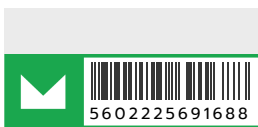

- Cobertura resistente à geada.
- Porta com fecho, permite cuidar e colher facilmente.
- Estrutura de aço resistente.
- Montagem fácil sem ferramenta.



**2 + 2 (71x33cm)**  
Prateleiras | Estantes | Shelves



143 x 73 x 195 cm



- Frost-resistant cover.
- Zipping door for easy care and harvesting.
- Sturdy steel frame.
- Easy assembly no tools required.

N. Ref.	Descrição	Marca	Quant. Caixa
69168	ESTUFA-MGD-160X160X180CM	MADER GARDEN TOOLS	1/1
69167	ESTUFA-MGD-143X73X195CM	MADER GARDEN TOOLS	1/1

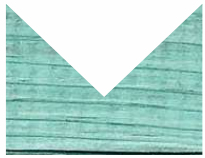

**MADER**®



**FERRAMENTA MANUAL**  
**HERRAMIENTA MANUAL | MANUAL TOOLS**

**MADER**®

**GARDEN  
TOOLS**

## TESOURA RAMOS TIJERA RAMAS ALTAS PRUNING SHEARS

Alumínio  
Aluminio  
Aluminium

## SERROTE DE RAMOS SERRUCHO RAMOS LONG ARM TREE SAW

**Cabeça rotativa**  
Cabeza giratoria  
Rotating head

**Cabo Extensível**  
Mango Extensible  
Extensible Handle



**162 cm**



**1.8 m → 2.92m**

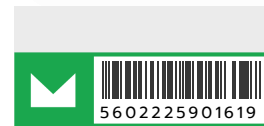

Lâmina / Cuchilla / Blade

**360mm**

N. Ref.	Descrição	Marca	Quant. Caixa
90101	TESOURA RAMOS-MGD-156CM	MADER GARDEN TOOLS	1
90161	SERROTE RAMOS EXTENS-MGD-292CM	MADER GARDEN TOOLS	12

## LÂMINA HOJA BLADE

**RAMOS ALTOS | RAMAS ALTAS | HIGH BRANCHES**



para Tesoura 90101  
para Tijera 90101  
for Scissor 90101



para Serrote 90161  
de Serrucho 90161  
for Long Arm Tree Saw 90161



**360 mm**



Alumínio  
Aluminio  
Aluminium

N. Ref.	Descrição	Marca	Quant. Caixa
90102	LÂMINA P/ TESOURA RAMOS 90101	MADER GARDEN TOOLS	50/50
90159	LÂMINA-MGD-P/SERROTE	MADER GARDEN TOOLS	12/12

### TESOURA PODAR PODADERA PRUNING SHEARS

ÁRVORES  
ÁRBOLES  
TREES

**DUPLO EIXO**  
DOBLE EJE  
DOUBLE AXIS



90105



5602225901053

28"



90100



5602225901008

30"



Cabo » Aço  
Mango » Acero  
Handle » Steel

N. Ref.	Descrição	Marca	Quant. Caixa
90105	TESOURA P/ARV-MGD-020AB 28"	MADER GARDEN TOOLS	12/12
90100	TESOURA PODAR ARV-MGD-14AN-30"	MADER GARDEN TOOLS	6/6

### LÂMINA PARA TESOURA HOJA DE PODADERA BLADE FOR CRAMP

ÁRVORES  
ÁRBOLES  
TREES

para Ref.: 90105-90106



90107



5602225901077



90154

para Ref.: 90105-90106



5602225901541



para Ref.: 90100



90158



5602225901589



90157

para Ref.: 90125

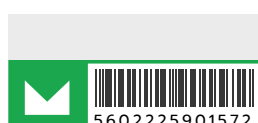

5602225901572



N. Ref.	Descrição	Marca	Quant. Caixa
90107	LÂMINA P/TESOURA 90105	MADER	150/150
90154	LÂMINA-MGD-P/TES.POD/ARV 020AL	MADER GARDEN TOOLS	120/120
90158	LÂMINA-MGD-P/T.PODA A014AN-BLD	MADER GARDEN TOOLS	1/25
90157	LÂMINA-MGD-P/T.PODA 017HQL-BL	MADER GARDEN TOOLS	25/25

## TESOURA PODAR PODADERA PRUNING SHEARS

ÁRVORES  
ÁRBOLES  
TREES

EXTENSÍVEL  
EXTENSIBLE

Cabo » Aço  
Mango » Acero  
Handle » Steel



90106



5602225901060

37"

480 » 795 mm



Cabo » Alumínio  
Mango » Aluminio  
Handle » Aluminum



90125



5602225901251

40"

490 » 825 mm



N. Ref.	Descrição	Marca	Quant. Caixa
90106	TESOURA P/ARV-MGD-EXT 014EC	MADER GARDEN TOOLS	12/12
90125	TESOUR POD ARV-MGD-C/EXT 17HQL	MADER GARDEN TOOLS	12/12

## TESOURA RELVA TIJERA CORTACÉSPED HEDGE SHEAR

AJUSTÁVEL  
AJUSTABLE  
ADJUSTABLE

LÂMINA ONDULADA  
LÁMINA ONDULADA  
WAVY BLADE

EXTENSÍVEL  
EXTENSIBLE

Cabo » Aço  
Mango » Acero  
Handle » Steel



90113



5602225901138

32"

335 » 515 mm



Cabo » Alumínio  
Mango » Aluminio  
Handle » Aluminum



90141



5602225901411

34"

345 » 555 mm



Lâmina / Cuchilla / Blade **200 mm**

N. Ref.	Descrição	Marca	Quant. Caixa
90113	TESOURA RELVA NGB 6410 C/EXT	MADER GARDEN TOOLS	1/12
90141	TESOURA RELVA-MGD-C/EXT 036WQL	MADER GARDEN TOOLS	12/12



**TESOURA RELVA**  
TIJERA CORTACÉSPED  
HEDGE SHEAR

**LÂMINA RETA**  
LÁMINA RECTA  
STRAIGHT BLADE



**18" (470 mm)**

Lâmina / Cuchilla / Blade **160 mm**

Cabo » Madeira  
Mango » Madera  
Handle » Wood

N. Ref.	Descrição	Marca	Quant. Caixa
90142	TESOURA RELVA-MGD-470MM	MADER GARDEN TOOLS	50/50

**TESOURA RELVA**  
TIJERA CORTACÉSPED  
HEDGE SHEAR

**LÂMINA ONDULADA**  
LÁMINA ONDULADA  
WAVY BLADE

**AJUSTÁVEL**  
AJUSTABLE  
ADJUSTABLE



**23"**

Lâmina / Cuchilla / Blade **200 mm**

Cabo » Madeira  
Mango » Madera  
Handle » Wood

N. Ref.	Descrição	Marca	Quant. Caixa
90130	TESOURA RELVA-MGD-029WGX-23"	MADER GARDEN TOOLS	12/12

**TESOURA RELVA**  
TIJERA CORTACÉSPED  
HEDGE SHEAR

**LÂMINA RETA**  
LÁMINA RECTA  
STRAIGHT BLADE



**26"**

Lâmina / Cuchilla / Blade **220 mm**

Cabo » Fibra Carbono  
Mango » Fibra Carbono  
Handle » Carbon Fiber

N. Ref.	Descrição	Marca	Quant. Caixa
90140	TESOURA RELVA-MGD-670MM	MADER GARDEN TOOLS	20/20

### TESOURA PODAR PODADERA PRUNING SHEAR

200 mm

215 mm

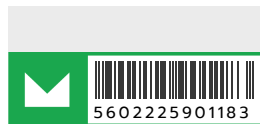

N. Ref.	Descrição	Marca	Quant. Caixa
90117	TESOURA PODAR-MGD-200MM	MADER GARDEN TOOLS	1/1
90118	TESOURA PODAR-MGD-215MM	MADER GARDEN TOOLS	1/1

Al Alloy Revestido  
Al Alloy Recubierto  
Coated Al Alloy

### TESOURA PARA PODAR PODADERA PRUNING SHEARS

ÁRVORES  
ÁRBOLES  
TREES



EXTENSÍVEL  
EXTENSIBLE

657 » 902 mm



Alumínio  
Aluminio  
Aluminum

N. Ref.	Descrição	Marca	Quant. Caixa
90103	TESOURA P/ARV-MGD-EXT 65-90CM	MADER GARDEN TOOLS	1/12

### TESOURA RELVA TIJERA CORTACÉSPED HEDGE SHEAR



EXTENSÍVEL  
EXTENSIBLE

750 » 950 mm



Alumínio  
Aluminio  
Aluminum

N. Ref.	Descrição	Marca	Quant. Caixa
90109	TESOURA RELVA-MGD-EXT 75-95CM	MADER GARDEN TOOLS	1/1

## TESOURA DE PODAR PODADERA PRUNING SHEAR

### MODELO NACIONAL NACIONAL MODEL



7" - 175mm

8" - 200 mm

9" - 225 mm

10" - 250 mm



5602225521671



5602225521688



5602225521695



5602225521701

N. Ref.	Descrição	Marca	Quant. Caixa
52167	TESOURA PODA-MGD-NACIONAL 7"	MADER GARDEN TOOLS	12/60
52168	TESOURA PODAR-MGD-NACIONAL 8"	MADER GARDEN TOOLS	60/12
52169	TESOURA PODAR-MGD-NACIONAL 9"	MADER GARDEN TOOLS	60/12
52170	TESOURA PODAR-MGD-NACIONAL 10"	MADER GARDEN TOOLS	10/50



## MOLA MUELLE SPRING



60 mm

52168 - 8"

70 mm

52169 - 9"

80 mm

52170 - 10"



5602225521732



5602225521749



5602225521756



N. Ref.	Descrição	Marca	Quant. Caixa
52173	MOLA P/ TESOURA PODAR-MGD-60MM	MADER GARDEN TOOLS	600/600
52174	MOLA P/ TESOURA PODAR-MGD-70MM	MADER GARDEN TOOLS	400/400
52175	MOLA P/ TESOURA PODAR-MGD-80MM	MADER GARDEN TOOLS	300/300

**TESOURA PODAR**  
**PODADERA**  
**PRUNING SHEAR**

**Cabo Anti-derrapante**  
**Mango Antideslizante**  
**Anti-slip Handle**

**Alumínio**  
**Aluminio**  
**Aluminium**



90150



56 02225901503

**210 mm**

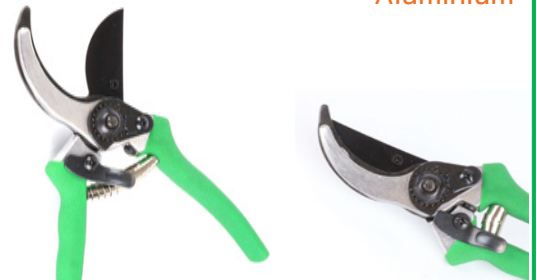

90155



56 02225901558

**PROFISSIONAL**  
**PROFESIONAL**  
**PROFESSIONAL**



N. Ref.	Descrição	Marca	Quant. Caixa
90150	TESOURA PODAR 420C PROF	MADER GARDEN TOOLS	10/60
90155	TESOURA PODAR 421A ALUMINIO	MADER GARDEN TOOLS	6/60

**TESOURA PODAR**  
**PODADERA**  
**PRUNING SHEAR**

**PROFISSIONAL**  
**PROFESIONAL**  
**PROFESSIONAL**



90121



56 02225901213

**200 mm**



90126



56 02225901268

**210 mm**



**TRAVÃO : 2 POSIÇÕES**  
**BLOQUEO: 2 POSICIONES**  
**LOCK : 2 POSITIONS**

N. Ref.	Descrição	Marca	Quant. Caixa
90121	TESOURA PODA-MGD-8" 466H	MADER GARDEN TOOLS	10/60
90126	TESOURA PODAR-MGD-210MM	MADER GARDEN TOOLS	10/60

**TESOURA PODAR**  
**PODADERA**  
**PRUNNING SHEAR**

**VINDIMA**  
**VENDIMIA**  
**GRAPE HARVEST**



**175 mm**

N. Ref.	Descrição	Marca	Quant. Caixa
52171	TESOURA VINDIMA-MGD-NACIONAL7"	MADER GARDEN TOOLS	12/60

**TESOURA DE ENXERTIA**  
**PODADERA INJERTO**  
**GRAFTING PRUNING SHEAR**

**3 TIPOS DE CORTE**  
**3 TYPES OF CUT**

**ENXERTIA DE GARFAGEM EM FENDA**  
**INJERTO EN HENDIDURA**  
**GRAFTING IN SLIT**



- 1x Tesoura**
- 2x Topos**
- 3x Lâminas**
- 1x Tijeras
- 2x Tops
- 3x Cuchillas
- 1x Scissor
- 2x Tops
- 3x Blades

N. Ref.	Descrição	Marca	Quant. Caixa
90137	TESOURA ENXERTIA-MGD-3 CORTES	MADER GARDEN TOOLS	20/20

## SERROTE DE ARCO SIERRA DE ARCO BOW SAW

## "LINHA PROF"

12" - 300 mm

**2 IN 1**



31059

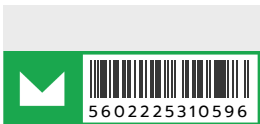

5602225310596

2 LÂMINAS » MADEIRA + FERRO  
2 LÁMINAS » MADERA + HIERRO  
2 BLADES » WOOD + IRON

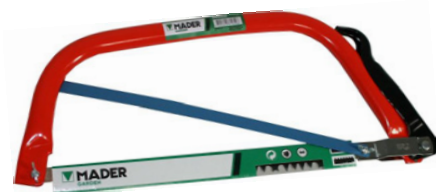

21" - 533 mm

24" - 610 mm



69002

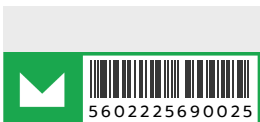

5602225690025



5602225690032

1 LÂMINA » MADEIRA  
1 LÁMINA » MADERA  
1 BLADE » WOOD

N. Ref.	Descrição	Marca	Quant. Caixa
31059	SERROTE 2IN1-MPL-MAD-FERRO 12"	MADER PLUS	12/12
69002	SERROTE ARCO PROF-MGD-533MM-21	MADER GARDEN TOOLS	12/12
69003	SERROTE ARCO PROF-MGD-610MM-24	MADER GARDEN TOOLS	12/12
	SE	MADER GARDEN TOOLS	

## LÂMINA PARA SERROTE ARCO HOJA PARA SIERRA ARCO BLADE FOR BOW SAW



96168

**MADEIRA SECA**  
MADERA SECA  
DRIED WOOD



10 / 12"

10 / 21"

10 / 24"



5602225961682



5602225961606



5602225961613



**DENTES DIREITOS**  
DIENTES RECTOS  
STRAIGHT TEETH



96165

**MADEIRA VERDE**  
MADERA VERDE  
GREEN WOOD

18 / 21"

18 / 24"



5602225961651



5602225961668



**DENTES ALTERNADOS**  
DIENTES ALTERNADOS  
ALTERNATE TEETH

N. Ref.	Descrição	Marca	Quant. Caixa
96168	LÂMINA C/MADEIRA-MPL-DD 10/12"	MADER PLUS	10/200
96160	LÂMINA C/MADEIRA-MPL-DD 10/21"	MADER GARDEN TOOLS	1/1
96161	LÂMINA C/MADEIRA-MPL-DD 10/24"	MADER GARDEN TOOLS	10/10
	LÂMINA C/MADEIRA-MPL-DD 10/30"	MADER PLUS	
96165	LÂMINA C/MADEIRA-MPL-DA 18/21"	MADER GARDEN TOOLS	10/200
96166	LÂMINA C/MADEIRA-MPL-DA 18/24"	MADER GARDEN TOOLS	10/200
	LÂMINA C/MADEIRA-MPL-DA 18/30"	MADER PLUS	

**SERROTE DE PODAR**  
SERRUCHO DE PODAR  
LOPPING SAW

**CABO ERGONÓMICO EM MADEIRA**  
MANGO ERGONÓMICO DE MADEIRA  
ERGONOMIC WOODEN HANDLE



**350 mm**

**Corte Madeira**  
Corte Madera  
Wood Cut

N. Ref.	Descrição	Marca	Quant. Caixa
69007	SERROTE PODAR-MGD-CURVO 350MM	MADER GARDEN TOOLS	50/50

**SERROTE DE PODAR**  
SERRUCHO DE PODAR  
LOPPING SAW

**LÂMINA TRIDIMENSIONAL DE AÇO SK5 COM DENTES DUROS**  
HOJA TRIDIMENSIONAL DE ACERO SK5 CON DIENTES ENDURECIDOS  
THREE-DIMENSIONAL SK5 STEEL BLADE WITH HARDENED TEETH

**270 mm**

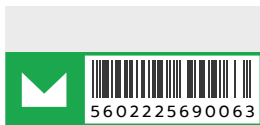

**Dentes em seção transversal**  
Dientes en la sección transversal  
Cross-section teeth arrangement

**300 mm**

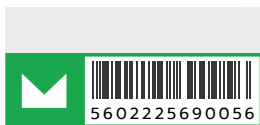

**Corte Madeira**  
Corte Madera  
Wood Cut

**CABO EM BORRACHA ANTIDERRAPANTE**  
MANGO DE GOMA ANTIDESLIZANTE  
NON-SLIP RUBBER HANDLE

N. Ref.	Descrição	Marca	Quant. Caixa
69006	SERROTE PODAR-MGD-270MM	MADER GARDEN TOOLS	15/60
69005	SERROTE PODAR-MGD-300MM	MADER GARDEN TOOLS	6/60

**Saco de ABS com dispositivo para fixação ao cinto**  
Bolsa de ABS con dispositivo de sujeción del cinturón  
ABS bag with belt clamping device

### CATANA MACHETE MACHETE

**2 IN 1 - Catana + Serra**  
Machete + Sierra | Machete + Saw

**Aço Temperado**  
Acero Temperado  
Tempered Steel



**18" - 450 mm**  
5 TPI



**CABO ERGONÔMICO » ALÇA EM POLIÉSTER**  
MANGO ERGONÓMICO » CORREA POLIÉSTER  
ERGONOMIC HANDLE » POLYESTER STRAP

N. Ref.	Descrição	Marca	Quant. Caixa
69008	CATANA-MGD-18" C/SERRA	MADER GARDEN TOOLS	1/24

### CILINDRO RELVA CILINDRO DE CESPED LAWN CYLINDER

**Metal**



Ø 320 x 500 mm

Ø 400 x 600 mm

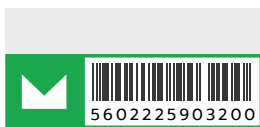

N. Ref.	Descrição	Marca	Quant. Caixa
90320	CILINDRO RELVA-MGD-500X320MM	MADER GARDEN TOOLS	1
90321	CILINDRO RELVA-MGD-600X400MM	MADER GARDEN TOOLS	1

**LUVAS PROTEÇÃO**  
GUANTES DE PROTECCIÓN  
PROTECTION GLOVES

Revestimento LATEX  
Revestimento de LÁTEX  
LATEX Coating

EN 388:2016  
CE



**S**

1 Par



**M**

1 Par



**L**

1 Par



**XL**

1 Par



N. Ref.	Descrição	Marca	Quant. Caixa
48233	LUVA LATEX-MGD-VERDE S C/BL	MADER GARDEN TOOLS	12
48234	LUVA LATEX-MGD-VERDE M C/BL	MADER GARDEN TOOLS	12
48227	LUVA LATEX-MGD-VERDE L C/BL	MADER GARDEN TOOLS	12
48228	LUVA LATEX-MGD-VERDE XL C/BL	MADER GARDEN TOOLS	12

**VASSOURA DE JARDIM**  
ESCOBA DE JARDÍN  
GARDEN BROOM

**Fio Polipropileno**  
Hilo Polipropileno  
Polypropylene Thread

**Cabo Madeira**  
Mango Madera  
Wooden Handle



**136cm**



N. Ref.	Descrição	Marca	Quant. Caixa
42361	VASSOURA JARDIM-MGD-PP 145CM	MADER GARDEN TOOLS	1/12

## VASSOURA DE RELVA ESCOBA CÉSPED GRASS BROOM

**Plástico**  
Plastic

**COM CABO MADEIRA**  
CON MANGO DE MADEIRA  
WITH WOOD HANDLE

**22**  
1.2m



5602225901466



**REGULÁVEL**  
REGULABLE  
ADJUSTABLE

**Metal**

**COM CABO METÁLICO**  
CON MANGO METALICO  
WITH METALLIC CABLE



**15**  
1.10 m



5602225901473

N. Ref.	Descrição	Marca	Quant. Caixa
90146	VASOURA RELVA-MGD-22D 12MM	MADER GARDEN TOOLS	50/50
90147	VASOURA RELVA-MGD-15D 15MM	MADER GARDEN TOOLS	50/50

## ANCINHO RASTRILLO RAKE

**12 Dentes**



5602225901435



**14 Dentes**



5602225901442



**16 Dentes**

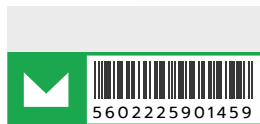

5602225901459

**CABO MADEIRA ENVERNIZADO**  
MANGO MADEIRA BARNIZADO  
VARNISHED WOOD HANDLE



**Cabo / Cable 120 m**

N. Ref.	Descrição	Marca	Quant. Caixa
90143	ANCINHO-MGD-12D	MADER GARDEN TOOLS	50/50
90144	ANCINHO-MGD-14D	MADER GARDEN TOOLS	50/50
90145	ANCINHO-MGD-16D	MADER GARDEN TOOLS	50/50

**ANCINHO**  
RASTRILLO  
RAKE

**CABO MADEIRA**  
MANGO MADERA  
WOOD HANDLE



10 Dentes



12 Dentes



14 Dentes



16 Dentes



18 Dentes



Cabo / Cable		120 m	
N. Ref.	Descrição	Marca	Quant. Caixa
44000	ANCINHO-MAD-10D C/MAD 1,2M 55A	MADER	6/6
44002	ANCINHO-MAD-12D C/MAD 1,2M 55A	MADER	6/6
44003	ANCINHO-MAD-14D C/MAD 1,2M 55A	MADER	6/6
44004	ANCINHO-MAD-16D C/MAD 1,2M 55A	MADER	6/6
44005	ANCINHO-MAD-18D C/MAD 1,2M 55A	MADER	1/1

**ANCINHO**  
RASTRILLO  
RAKE

**REFORÇADO**  
REFORZADO  
REINFORCED

**Cabo Envernizado**  
Mango Barnizado  
Varnished Handle



10 Dentes



12 Dentes

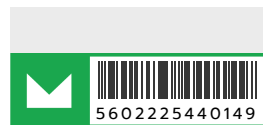

14 Dentes



16 Dentes



N. Ref.	Descrição	Marca	Quant. Caixa
44013	ANCINHO CB ENVER DENT QUAD-10D	MADER	6/12
44014	ANCINHO CB ENVER DENT QUAD-12D	MADER	6/12
44015	ANCINHO CB ENVER DENT QUAD-14D	MADER	6/12
44016	ANCINHO CB ENVER DENT QUAD-16D	MADER	6/12

**Dente quadrado**  
Diente cuadrado  
Square teeth

## CABO MADEIRA MANGO MADERA WOOD HANDLE

ENVERNIZADO  
BARNIZADA  
VARNISHED



**0.90 m**  
Ø 35 / 50 mm



**Picareta**  
Piqueta  
Pickaxe

**1 m**  
Ø 40 / 55 mm



**Machado**  
Hacha  
Axe

**1.20 m**  
Ø 25 / 35 mm



**FINO**  
DELGADO  
THIN

**Sacho**  
Azada  
Weeding Hoe

**1.40 m**  
Ø 25 / 35 mm



**Sacho**  
Azada  
Weeding Hoe

**1.30 m**  
Ø 30 / 40 mm



**Enxada**  
Azada  
Hoes

**1.40 m**  
Ø 30 / 40 mm



**Enxada**  
Azada  
Hoes

N. Ref.	Descrição	Marca	Quant. Caixa
42387	CABO PICARETA ENVERNIZ 0,90M	MADER	1/1
42388	CABO MACHADO ENVERNIZADO 1M	MADER	1/1
42390	CABO SACHO FINO ENVERNIZ 1,20M	MADER	1/1
42389	CABO SACHO ENVERNIZADO 1,40M	MADER	1/1
42392	CABO ENXADA ENVERNIZADO 1,30M	MADER	1/1
42391	CABO ENXADA ENVERNIZADO 1,40M	MADER	1/1

## FORQUILHA FENO FORQUILHA FENO HAY FORK

IDEAL PARA FENO  
IDEAL PARA HENO  
IDEAL FOR HAY

**DIREITA**  
RECTO  
STRAIGHT



**4 Dentes**

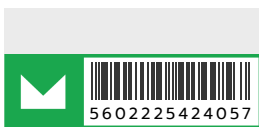

**5 Dentes**



**CURVA**  
CURVED



**5 Dentes**



N. Ref.	Descrição	Marca	Quant. Caixa
42405	FORQUILHA FENO-MAD-DT® 4DENTES	MADER	12/12
98885	FORQUILHA-BAL-5 D-DT®S 303/5	BALEOTE	1/1
98884	FORQUILHA-BAL-5 D CURVOS 302/5	BALEOTE	1/1

sem Cabo  
sin Mango  
without Handle

## FORQUILHA BRITA

HORCA JARDÍN GRAVA TRITURADA  
GARDEN FORK CRUSHED STONE

**DIREITA**  
RECTO  
STRAIGHT

**CABO METAL**  
MANGO METAL  
METAL HANDLE



4 Dentes



5 Dentes



**CABO MADEIRA**  
MANGO MADERA  
WOODEN HANDLE



8 Dentes



**IDEAL PARA BRITA**  
IDEAL PARA GRAVA TRITURADA  
IDEAL FOR CRUSHED STONE

N. Ref.	Descrição	Marca	Quant. Caixa
44041	FORQUILHA DIR-BAL-C/C MET 4D	BALEOTE	6/6
44042	FORQUILHA FENO-BAL-C/C MET 5D	BALEOTE	6/6
44040	FORQUILHA BRITA-BAL-C/C MAD 8D	BALEOTE	6/6

## CAVADEIRA

CAVA MOYOS  
POST HOLE DIGGER

**CABO METAL**  
MANGO METAL  
METAL HANDLE

4" x 9"  
1.40 m

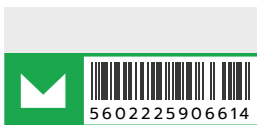

**CABO MADEIRA**  
MANGO MADERA  
WOOD HANDLE

4" x 9"  
1.40 m

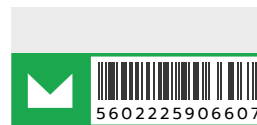

N. Ref.	Descrição	Marca	Quant. Caixa
90661	ABRE BURACOS-BAL-C/MET	BALEOTE	1/1
90660	CAVADEIRA-BAL-C/MAD 4X9-92AB	BALEOTE	1/1

**RODO ESPONJA**  
RASQUETA DE ESPONJA  
SPONGE SQUEEGER

**CABO MADEIRA**  
MANGO MADERA  
WOOD HANDLE

**ESPONJA**  
SPONGE

**450 mm**  
1.40 m

**550 mm**  
1.40 m

**750 mm**  
1.40 m

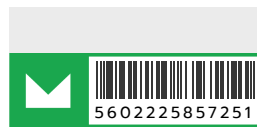
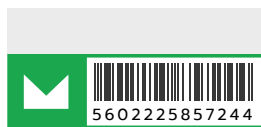

N. Ref.	Descrição	Marca	Quant. Caixa
85723	RODO ESPONJA-SDX-C/C 3055 45	SINDEX	1/1
85724	RODO ESPONJA-SDX-C/C 3056 55	SINDEX	10/10
85725	RODO ESPONJA-SDX-C/C 3057 75	SINDEX	1/1

**RODO**  
RASQUETA  
SQUEEGER

**CABO MADEIRA**  
MANGO MADERA  
WOOD HANDLE

**BORRACHA**  
GOMA  
RUBBER

**500 mm**  
1.00 m



**260 mm**  
1.20 m

**MEIA LUA**  
MEDIA LUNA  
HALF MOON

**METAL**



N. Ref.	Descrição	Marca	Quant. Caixa
85409	RODO BORRACHA-SDX-50CM C/MAD	SINDEX	1/1
44037	RODO 1/2 LUA C/C RF 104 BALEIA	MADER	1/1

**SACHO**  
AZADA  
WEEDING HOE

**CABO MADEIRA**  
MANGO MADERA  
WOOD HANDLE



44031

**3 Dentes + Peta**  
3 Dientes + Pico  
3 Teeth + Tip



56 02225440316



44034

**Pá + Peta**  
Palote + Pico  
Trowel + Tip



56 02225440323

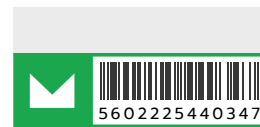

56 02225440347

**C1**

**C2**



**Cabo / Cable** **1,20 m**

N. Ref.	Descrição	Marca	Quant. Caixa
44031	SACHO C/PETA C/C 3 DENTES	MADER GARDEN TOOLS	1/1
44032	SACHO C/PETA C/C REF 100/1	MADER GARDEN TOOLS	1/1
44034	SACHO C/PETA C/C REF 100/2	MADER GARDEN TOOLS	1/1

**PÁ QUADRADA**  
PALA CAJADA  
SQUARE SHOVEL

**CABO EM MADEIRA**  
MANGO EN MADERA  
WOOD HANDLE

**Aço Temperado**  
Acero Temperado  
Tempered Steel



**1560 mm**  
260 x 190/160 mm



90313



56 02225903132



**VENDA MÍNIMA DE 6 UN**  
**(OU MÚLTIPLOS - 12, 18, 24, ...)**  
**VENTA MÍNIMA DE 6 UN**  
**(O MÚLTIPLOS - 12, 18, 24, ...)**  
**MINIMUM SALE BY 6 UN**  
**(OR MULTIPLES - 12, 18, 24, ...)**

**Cabo / Cable** **1300 mm**

N. Ref.	Descrição	Marca	Quant. Caixa
90313	PÁ QUADRADA-MGD-C/CABO MADEIRA	MADER GARDEN TOOLS	6/6

### PÁ PALA SHOVEL

**Cabo em Madeira**  
Mango en Madera  
Wood Handle



**BICO  
PUNTA  
ROUND SHOVEL**

**780 mm**  
150 x 210 mm



**QUADRADA  
CAJADA  
SQUARE**

**660 mm**  
150 x 280 mm



**D**

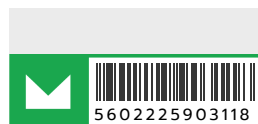

N. Ref.	Descrição	Marca	Quant. Caixa
90310	PÁ BICO-MGD-C/CABO 780MM T/D	MADER GARDEN TOOLS	12/12
90311	PÁ QUADRAD-MGD-C/CAB 660MM T/D	MADER GARDEN TOOLS	12/12

### PÁ DOBRÁVEL PALA PLEGABLE FOLDABLE SHOVEL



**COM BOLSA  
CON BOLSA  
WITH BAG**



**25 x 100 mm**  
Peta | Pico | Tip



**400 mm**  
95 x 130 mm



N. Ref.	Descrição	Marca	Quant. Caixa
90312	PÁ DOBRAVEL-MGD-400MM	MADER GARDEN TOOLS	50/50

**SACHO**  
AZADA  
WEEDING HOE



**Cabo Madeira**  
Mango Madera  
Wood Handle

**350 mm**



90309



5602225903095



**CABO METAL**  
MANGO METAL  
METAL HANDLE

**295 mm**



90308

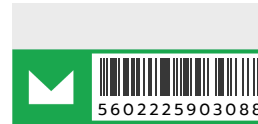

5602225903088



**COM BÚSSOLA**  
CON BRÚJULA  
WITH COMPASS

N. Ref.	Descrição	Marca	Quant. Caixa
90309	SACHO-MGD-350MM	MADER GARDEN TOOLS	50/50
90308	SACHO C/PETA-MGD-295MM	MADER GARDEN TOOLS	50/50

**Pá + Peta**  
Palote + Pico  
Trowel + Tip

**SACHO**  
AZADA  
WEEDING HOE

**CABO METÁLICO**  
MANGO METÁLICO  
METAL HANDLE



56022254424231

**CURVO**  
PICO  
NIP

**CABO MADEIRA**  
MANGO MADEIRA  
WOODEN HANDLE



360 mm



**3** Dentes  
Dientes  
Teeth

Descrição: **Sacho Jardim**  
Marca: **Mader Garden**

N. Ref.	Especificação	Quant. Caixa:
42423	cabo Madeira - Curvo	6
44010	cabo Metal - c/ Lança	6
44011	cabo Metal - c/ Peta	6
44012	cabo Metal - 3 Dentes	6



56022254440101

**PÁ + LANÇA**  
PALOTE + LANÇA  
TROWEL + LANCE



56022254440118

**PÁ + PETA**  
PALOTE + PICO  
TROWEL + TIP



56022254440125

**3 DENTES + PÁ**  
3 DIENTES + PALOTE  
3 TEETH + TROWEL

**PÁ ESTREITA**  
PALOTE ESTRECHA  
NARROW TROWEL

**Polipropileno**



90173



5602225901732



90172



5602225901725

**GRADUADA**  
SCALED



**SACHO COM ANCINHO**  
AZADA CON RASTRILLO  
DOUBLE DUTY HOE



90169



5602225901695



**3 DENTES**  
3 DIENTES  
3 TEETH

N. Ref.	Descrição	Marca	Quant. Caixa
90173	PÁ ESTREITA-MGD-PLP	MADER GARDEN TOOLS	1/1
90172	PÁ LARGA-MGD-PLP	MADER GARDEN TOOLS	1/1
90169	SACHO C/ANCINHO-MGD-PLP	MADER GARDEN TOOLS	1/1

**INOX**

**CABO REVESTIDO**  
MANGO REVESTIDO  
COATED HANDLE



90176



5602225901763

**PÁ DE JARDIM**  
PALOTE DE JARDÍN  
GARDEN SHOVEL



90178



5602225901787

**SACHO COM ANCINHO**  
AZADA CON RASTRILHO  
GRANDE PRONG



**3 DENTES**  
3 DIENTES  
3 TEETH



90179



5602225901794

**ANCINHO**  
RASTRILLO  
RAKE



**5 DENTES**  
5 DIENTES  
5 TEETH

N. Ref.	Descrição	Marca	Quant. Caixa
90176	PÁ JARDIM-MGD-INOX 650B-2	MADER GARDEN TOOLS	1/48
90178	SACHO C/ANCINHO-MGD-INOX 650H	MADER GARDEN TOOLS	12/48
90179	ANCINHO 5D-MGD-INOX 650M	MADER GARDEN TOOLS	1/1

**PÁ DE JARDIM**  
PALOTE DE JARDÍN  
GARDEN SHOVEL



**INOX**

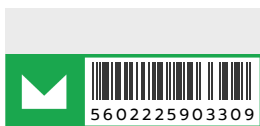

330 x 80 mm

**PP + TPR**

N. Ref.	Descrição	Marca	Quant. Caixa
90330	PÁ JARDIM-MGD-330X80MM	MADER GARDEN TOOLS	1/12

**PÁ DE JARDIM**  
PALA DE JARDÍN  
GARDEN TROWEL



690 » 940 mm

**EXTENSÍVEL**  
EXTENSIBLE



705 » 955 mm

**Aço Carbono**  
Acero Carbono  
Carbon Steel



750 » 995 mm

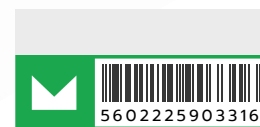
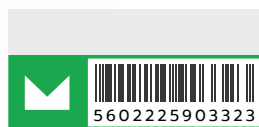

N. Ref.	Descrição	Marca	Quant. Caixa
90333	PÁ-MGD-EXT 69-94CM	MADER GARDEN TOOLS	1/12
90332	ANCINHO-MGD-EXT 70,5X95,5CM	MADER GARDEN TOOLS	1/12
90331	VASSOURA JARDIM-MGD-75-99,5CM	MADER GARDEN TOOLS	1/12

**Cabo PVC**  
Cable PVC  
PVC Cable

## PLANTADOR PLANTADOR DIBBER



06067



5600273802872

# 40 mm

190 mm

**Plástico**  
Plastic

Punho | Mango | Handle: 10 cm  
Ponteira | Puntera | Tip: 19 cm



90316



5602225903163

Ø 26 mm

170 mm

**Plástico**  
Plastic

COM ESCALA DE PROFUNDIDADE - 100 MM  
CON ESCALA DE PROFUNDIDAD - 100 MM  
WITH DEPTH SCALE - 100 MM



90315



5602225903156

Ø 25 mm

125 mm

**Madeira + Zinco**  
Madera + Zinc  
Wood + Zinc

COM ESCALA DE PROFUNDIDADE - 120 MM  
CON ESCALA DE PROFUNDIDAD - 120 MM  
WITH DEPTH SCALE



44044



5602225440446

Ø 33 mm

175 mm

**Madeira + Alumínio**  
Madera + Aluminio  
Wood + Aluminium

COM ESCALA DE PROFUNDIDADE - 100 MM  
CON ESCALA DE PROFUNDIDAD - 100 MM  
WITH DEPTH SCALE - 100 MM



90317

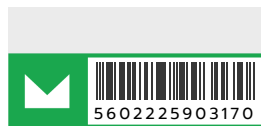

5602225903170

Ø 80 mm

230 mm

**Metal**

**Cabo Plástico**  
Mango Plástico  
Plastic Handle



N. Ref.	Descrição	Marca	Quant. Caixa
06067	PLANTADOR 40 CINZA	MADER GARDEN TOOLS	50/50
90316	PLANTADOR-MGD-170X26MM	MADER GARDEN TOOLS	50/50
90315	PLANTADOR-MGD-C/MAD ZINC 290MM	MADER GARDEN TOOLS	100/1
44044	PLANTADOR AL-MGD-C/MAD 320MM	BALEOTE	1/1
90317	TRANSPLANTADOR-MGD-230X80MM	MADER GARDEN TOOLS	50/50

## COMEDOURO COMEDERO FEEDER

INTERIOR  
INDOOR

REDONDO  
ROUND



1,5Kg 29349



5Kg 29350



8Kg 29351



16Kg 29352



16Kg 29353

EXTERIOR  
OUTDOOR

Descrição: Comedouro - Redondo

Marca: Mader Garden

N. Ref.	Especificação	Quant. Caixa:
29349	Interior - 1,5 Kg	12
29350	Interior - 5,0 Kg	12
29351	Interior - 8,0 Kg	6
29352	Interior - 16,0 Kg	6
29353	Exterior - 16,0 Kg	6
29347	Interior - 50 cm - Rectangular	12
29348	Interior - 60 cm - Rectangular	12



INTERIOR  
INDOOR

RETANGULAR



500mm  
29347



600x150mm  
29348

## BEBEDOURO

BEBEDERO  
DRINKING BOWL

REDONDO  
ROUND



1L 29354



2,5L 29355



4L 29356



6L 29357

Descrição: Bebedouro - Redondo

Marca: Mader Garden

N. Ref.	Especificação	Quant. Caixa:
29354	1,0 L	12
29355	2,5 L	12
29356	4,0 L	10
29357	6,0 L	12
29358	8,0 L	6
29359	13,0 L	6



8L 29358



13L 29359

### DOSEADOR GRADUADO MEDIDORA GRADUADA GRADUATED MEASURER



**50mL** 29310



**100mL** 29311



**250mL** 29312



**500mL** 29313



**1000mL** 29314



**2000mL** 29315

Descrição: Doseador - Agroquímico

Marca: Mader Garden

N. Ref.	Especificação	Quant. Caixa:
29310	Graduado - 50 mL	12
29311	Graduado - 100 mL	12
29312	Graduado - 250 mL	12
29313	Graduado - 500 mL	12
29314	Graduado - 1000 mL	12
29315	Graduado - 2000 mL	12

**AGROQUÍMICO**  
**AGROQUIMICA**  
**AGROCHEMICAL**

### COLHER MEDIDORA CUCHARILLA MEDIDORA MEASURING SPOON



**CONCAVA**  
**CONCAVE**



**190mm** 29329



**240mm** 29331



**290mm** 29327



**340mm** 29323



**380mm** 29324

**PLÁSTICO**  
**PLASTIC**

Descrição: Colher Medidora - Plástica

Marca: Mader Garden

N. Ref.	Especificação	Quant. Caixa:
29329	19 cm	6
29331	24 cm	6
29327	29 cm	6
29323	34 cm	6
29324	38 cm	6
29325	Rasa	6

**RASA**  
**FLAT**



**RASA** 29325



### TREMPE FERRO TREMPE GAS COOKER



**380 x 380 mm**



**FERRO  
HIERRO  
IRON**

**Gás | Gas:**  
LPG (70% butano / 30% propano)  
Ignição manual | Encendido manual

Altura / Height	<b>h - 140 mm</b>
Potência / Potencia / Power	<b>QN = 5.6KW</b>
Pressão / Presión / Pressure	<b>2.5-3.5kpa</b>

N. Ref.	Descrição	Marca	Quant. Caixa
69101	TREMPE-MGD-C/PERNAS	MADER GARDEN TOOLS	4/4

### FOGAREIRO A GÁS HORNILLO A GAS GAS STOVE

**ESTRUTURA EM INOX  
ESTRUCTURA DE INOX  
STAINLESS STEEL STRUCTURE**

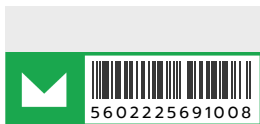

**227g**



**Botija de gás não incluída  
Bombona gas no incluida  
Gas bottle not included**

N. Ref.	Descrição	Marca	Quant. Caixa
69100	FOGÃO-MGD-1BOCA C/CX PLÁSTICA	MADER GARDEN TOOLS	1/6

### RECARGA DE GÁS RECARGA GAS GAS RECHARGE



**190g**



**com Válvula de Segurança  
con Válvula Seguridad  
with Safety Valve**

**BUTANO  
BUTANE**



**227 g**



**COMPATÍVEL COM VÁRIAS MARCAS DE FOGAREIROS  
COMPATIBLE CON VARIAS MARCAS DE HORNILLOS  
COMPATIBLE WITH VARIOUS BRANDS OF STOVES**

N. Ref.	Descrição	Marca	Quant. Caixa
67530	RECARGA GÁS-MPT-190GR C/VAL SEG	MADER POWER TOOLS	36/36
69105	RECARGA GÁS-MGD-227GR	MADER GARDEN TOOLS	4/28



**MADER**<sup>®</sup>

**GARDEN  
TOOLS**

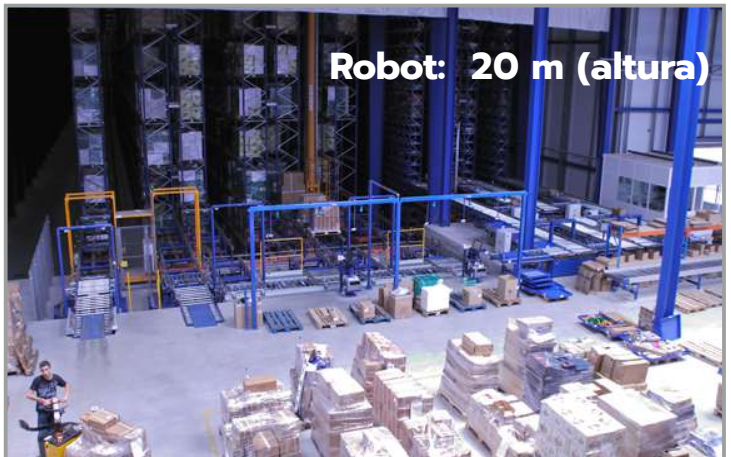

**Robot: 20 m (altura)**



**Show Room: 800 m<sup>2</sup>**



**Desde 1971**

**Área : 23.000 m<sup>2</sup>**

**MADER**<sup>®</sup>

**TRABALHA COMO UM PROFISSIONAL**

**M MADER®**

**M MADEIRA®**  
MADEIRA & MADEIRA

Zona Industrial da Pedrulha, lote 13  
3050-183 Casal Comba | Mealhada, Portugal  
Apartado 100, 3050-901 Mealhada

T. +351 231 200 200  
F. +351 231 200 201  
Tm. +351 919 854 879  
geral@mader.pt  
www.mader.pt



PME líder'22



Management  
System  
ISO 9001:2015

www.tuv.com  
ID: 9105073648