

CATALIST  
ENGLISH



› SWING AND SLIDING GATES MOTORS

› ACCESS CONTROL SYSTEMS

› ROAD BARRIERS AND BOLLARDS

› MOTORS FOR SHUTTERS AND AWNINGS

› GARAGE DOOR MOTORS AND AUTOMATIC DOORS



Automatic Passion

**VDS**  
AUTOMAZIONI  
MADE IN ITALY®



# Download myVDS App

All the VDS experience  
from today available  
for iOS e Android.

You can consult manuals, tutorial  
videos, technical sheets and have  
a VDS specialist at your disposal.



# VDS AUTOMATION LIST 2024

<b>Swing Gates</b>	<b>5</b>
Arm automations for Swing Gates	7
Underground automations for Swing Gates	21
Hydraulic automations for Swing Gates	25
<b>Sliding Gates</b>	<b>31</b>
<b>Garage Doors</b>	<b>47</b>
<b>Road Barriers</b>	<b>57</b>
<b>Traffic Bollards</b>	<b>67</b>
<b>Rolling Shutters</b>	<b>73</b>
<b>Shutters and Awings</b>	<b>79</b>
<b>Skylights, Windows, Domes</b>	<b>93</b>
<b>Sliding Doors &amp; Turnstiles</b>	<b>97</b>
<b>Electronic Control Board</b>	<b>111</b>
Control Board	112
Radio Systems	116
<b>Automation Accessories</b>	<b>119</b>
Access Control	120
Safety and Detection	124
Signaling	128
Mechanical	130
Generic	132

The background features a solid blue field with a large, vibrant orange geometric shape on the left side, consisting of a triangle and a trapezoid. The text is centered in the blue area.

# AUTOMATIONS FOR **SWING GATES**

ARM AUTOMATIONS FOR  
**SWING GATES**

# PM | PM1

## LINEAR ELECTROMECHANICAL OPERATOR 230V

**i** LEAF LENGHT UP TO 3,5 MT



INSTRUCTIONS



RESIDENTIAL



COLLECTIVE



POWER SUPPLY 230V



REVERSIBLE



IRREVERSIBLE

### FEATURES

- Sturdy aluminum structure
- Rod stroke MM300-MM400-MM600
- Stainless steel rod with scraper
- Very quiet operation
- Electric motor with electrobrake (PM 1)
- Thermal cut out 140°
- Manual release with customized key
- Lithium grease lubrications of mechanical parts against corrosion, oxidation and rust
- 120° opening
- Quick installation with multi-position brackets and cover for brackets in technopolimers
- Anti-squashing system \* (EN 12453)
- Slowing down function \* (EN 12453)
- Power supply 230V

\* Functions guaranteed with VDS electronics devices

### PERFORMANCE REQUIREMENTS

- Operating Cycle SEMI-INTENSIVE
- Use frequency 50%
- Opening time 15-25-30 SEC
- Thrust 1500 N

### TECHNICAL FEATURES

Power supply	230VAC
Leaf weight	250 KG
Leaf lenght	3,50 M
Engine RPM	800 RPM
Average absorption	1A
Absorbed power	250 W
Standard limit switch	NO
Condenser	12,5 UF
Motor weight	7,5 KG
Noise level	<30 DBA
Enviromental conditions	-20/+55° C
Protection degree	IP55

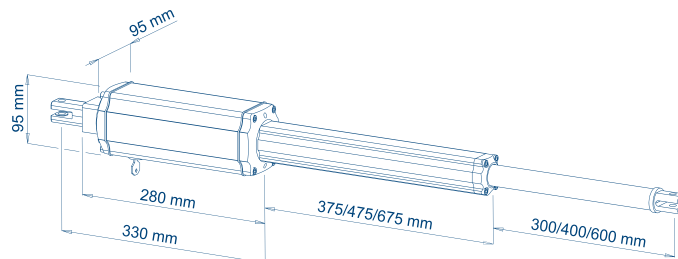

## OPERATORS AND ACCESSORIES

CODE	MODEL	DESCRIPTION
100053	PM1-300*	Irreversible - Stroke 300 mm - Leaf length up to 1,80 mt ●
100053/1	PM1-400*	Irreversible - Stroke 400 mm - Leaf length up to 2,50 mt ●
100053/13	PM1-600*	Irreversible - Stroke 600 mm - Leaf length up to 3,50 mt ●
100052	PM-300**	Reversible - Stroke 300 mm - Leaf length up to 1,80 mt ●
100052/1	PM-400**	Reversible - Stroke 400 mm - Leaf length up to 2,50 mt ●
100053/14	PM-600**	Reversible - Stroke 600 mm - Leaf length up to 3,50 mt ●
121060	CPS-300	Rod cover - Stroke 300 mm
111	CPS 400	Rod cover - Stroke 400 mm
111/1	CPS 600	Rod cover - Stroke 600 mm
140102	STR	Adjustable rear bracket



PZ. PALLET  
800x1200x1100 | 30 pz. 280 KG

- \* For **PM1** (irreversible) for leaf longer than 1,80 mt is suggested the use of an electric lock
- \*\* For **PM** (reversible) is always required the use of the electro lock
- For better radio reception we recommend the use of an external aerial code 210/1
- In the presence of strong wind and cold temperatures, the performance of the actuator can be significantly reduced

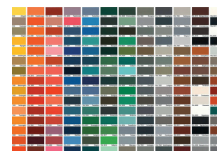

### COLOR SUPPLEMENT

Customize your motor by indicating the RAL code on the order

### KIT CONTENT



**COD. E105**  
Control board 230V



**COD. 12/C**  
Pair of photocells



**COD. 23/8**  
LED flashing light



**COD. 198/5**  
Key selector



**COD. E010**  
Remote control



**COD. 165B**  
Warning sign

### KIT 2 LEAVES

CODE	MODEL	DESCRIPTION
112550	KIT PM1-300*	Kit 2 leaves for gates up to 3,60 mt ●
112550/4	KIT PM1-400*	Kit 2 leaves for gates up to 5 mt ●
112542/8	KIT PM1-600*	Kit 2 leaves for gates up to 7 mt ●
112542	KIT PM-300**	Kit 2 leaves for gates up to 3,60 mt ●
112542/4	KIT PM-400**	Kit 2 leaves for gates up to 5 mt ●
112542/6	KIT PM-600**	Kit 2 leaves for gates up to 7 mt ●



PZ. PALLET  
800x1200x1200 | 15 pz. 270 KG

### KIT 1 LEAF

CODE	MODEL	DESCRIPTION
112557	KIT PM1-300*	Kit 1 leaf for gates up to 1,80 mt ●
112550/3	KIT PM1-400*	Kit 1 leaf for gates up to 2,50 mt ●
1200041/1	KIT PM1-600*	Kit 1 leaf for gates up to 3,50 mt ●
112556	KIT PM-300**	Kit 1 leaf for gates up to 1,80 mt ●
112556/1	KIT PM-400**	Kit 1 leaf for gates up to 2,50 mt ●
112556/6	KIT PM-600**	Kit 1 leaf for gates up to 3,50 mt ●

### EXTRA ACCESSORIES

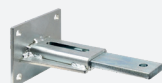

**COD. 140102**  
Adjustable rear bracket

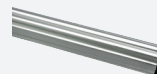

**COD. CPS**  
Rod cover

# PM1-SC

## LINEAR ELECTROMECHANICAL OPERATOR 230V - 24V

**i LEAF LENGHT UP TO 3 MT**



INSTRUCTIONS



RESIDENTIAL



COLLECTIVE



POWER SUPPLY 230V - 24V



IRREVERSIBLE

### FEATURES

- Sturdy aluminum structure
- Rod stroke MM 300 - MM 400 - MM 500
- Strong rolled warm shaft
- Standard opening limit switch (optional in closing)
- Very quiet operation
- High Performance electric motor
- Thermal cut out 140°
- Manual release with key
- Lithium grease lubrications of mechanical parts against corrosion, oxidation and rust
- 120° opening
- Quick installation with multi-position brackets and cover for brackets in technopolimers
- Anti-squashing system \* (EN 12453)
- Slowing down function \* (EN 12453)
- Power supply 230V - 24V
- Optional kit Battery Back-up

\* Functions guaranteed with VDS electronics devices

### PERFORMANCE REQUIREMENTS

- Operating Cycle SEMI-INTENSIVE 230V, INTENSIVE 24V
- Use frequency 50% (230V) - 90% (24V)
- Opening time 15 - 25 - 30 SEC
- Thrust 1500 N

### TECHNICAL FEATURES

	PM1-SC 230V	PM1-SC 24V
Power supply	230VAC	24VCC
Leaf weight	200 KG	200 KG
Leaf lenght	3 MT	3 MT
Engine RPM	1400 RPM	1500 RPM
Average absorption	1 A	3 A
Absorbed power	200 W	50 W
Standard limit switch	OPENING	OPENING
Condenser	16 UF	-
Motor weight	6,5 KG	6,5 KG
Noise level	< 30 DBA	< 30 DBA
Enviromental conditions	-20 / +55° C	-20 / +55° C
Protection degree	IP55	IP55

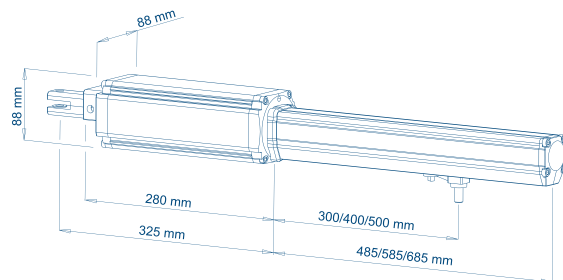

## OPERATORS AND ACCESSORIES

COD	MOD	DESCRIZIONE
100038	PM1-SC 300-230V	Irreversible - Stroke 300 mm - Leaf lenght up to 1,80 mt
121820	PM1-SC 400-230V*	Irreversible - Stroke 400 mm - Leaf lenght up to 2,50 mt
121820/2	PM1-SC 500-230V*	Irreversible - Stroke 500 mm - Leaf lenght up to 3 mt
100038/24	PM1-SC 300-24V	Irreversible - Stroke 300 mm - Leaf lenght up to 1,80 mt
121841/24	PM1-SC 400-24V*	Irreversible - Stroke 400 mm - Leaf lenght up to 2,50 mt
121822/24	PM1-SC 500-24V*	Irreversible - Stroke 500 mm - Leaf lenght up to 3 mt
140102	STR	Adjustable rear bracket



PZ. PALLET  
800x1200x1200 | 30 pz. 270 KG

- \* For **PM1-SC** for leaf longer than 1,80 mt is suggested the use of an electric lock
- For better radio reception we recommend the use of an external aerial code 210/1
- In the presence of strong wind and cold temperatures, the performance of the actuator can be significantly reduced

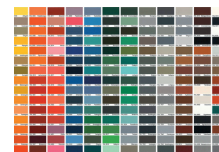

### COLOR SUPPLEMENT

Customize your motor by indicating the RAL code on the order

### KIT CONTENT

The kit contains **1 control board** + accessories



**COD. E105**  
Control board 230V



**COD. F103**  
Control board 24V



**COD. 12/C**  
Pair of photocells



**COD. 23/8**  
LED flashing light



**COD. 198/5**  
Key selector



**COD. E010**  
Remote control



**COD. 165B**  
Warning sign

### KIT 2 LEAVES

CODE	MODEL	DESCRIPTION
112537/2	KIT PM1-SC 300-230V	Kit 2 leaves for gates up to 3,60 mt
112565	KIT PM1-SC 400-230V*	Kit 2 leaves for gates up to 5 mt
121820/4	KIT PM1-SC 500-230V	Kit 2 leaves for gates up to 6 mt
112537/24	KIT PM1-SC 300-24V	Kit 2 leaves for gates up to 3,60 mt
112735/24	KIT PM1-SC 400-24V*	Kit 2 leaves for gates up to 5 mt
121822/5	KIT PM1-SC 500-24V*	Kit 2 leaves for gates up to 6 mt



PZ. PALLET  
800x1200x1200 | 15 pz. 250 KG

### KIT 1 LEAF

CODE	MODEL	DESCRIPTION
110537/1	KIT PM1-SC 300-230V	Kit 1 leaf for gates up to 1,80 mt
11256	KIT PM1-SC 400-230V*	Kit 1 leaf for gates up to 2,50 mt
121820/5	KIT PM1-SC 500-230V*	Kit 1 leaf for gates up to 3 mt
110537/2	KIT PM1-SC 300-24V	Kit 1 leaf for gates up to 1,80 mt
110537/4	KIT PM1-SC 400-24V*	Kit 1 leaf for gates up to 2,50 mt
110537/3	KIT PM1-SC 500-24V*	Kit 1 leaf for gates up to 3 mt

### EXTRA ACCESSORIES



**COD. 140102**  
Adjustable rear bracket

# EGO

## LINEAR ELECTROMECHANICAL OPERATOR 230V - 24V

**i** LEAF LENGHT UP TO 3 MT



INSTRUCTIONS

RESIDENTIAL

COLLECTIVE

POWER SUPPLY 230V - 24V

IRREVERSIBLE

### FEATURES

- Sturdy aluminum structure
- Rod stroke MM 400 - MM 500
- Stainless steel rod
- Optional limit switch
- Very quiet operation
- High Performance electric motor
- Thermal cut out 140°
- Manual release with key
- Lithium grease lubrications of mechanical parts against corrosion, oxidation and rust
- 120° opening
- Quick installation with multi-position brackets and cover for brackets in technopolimers
- Anti-squashing system \* (EN 12453)
- Slowing down function \* (EN 12453)
- Power supply 230V - 24V
- Optional kit Battery Back-up

\* Functions guaranteed with VDS electronics devices

### PERFORMANCE REQUIREMENTS

- Operating Cycle SEMI-INTENSIVE 230V, INTENSIVE 24V
- Use frequency 50% (230VAC) - 90% (24VCC)
- Opening time 20 - 25 SEC
- Thrust 2000 N

### TECHNICAL FEATURES

	EGO 230	EGO 24
Power supply	230VAC	24VCC
Leaf weight	200 KG	200 KG
Leaf lenght	3 MT	3 MT
Engine RPM	1400 RPM	2800 RPM
Average absorption	1 A	3 A
Absorbed power	200 W	50 W
Standard limit switch	OPTIONAL	OPTIONAL
Condenser	10 UF	-
Motor weight	6,5 KG	6,5 KG
Noise level	< 30 DBA	< 30 DBA
Enviromental conditions	-20 / +55° C	-20 / +55° C
Protection degree	IP55	IP55

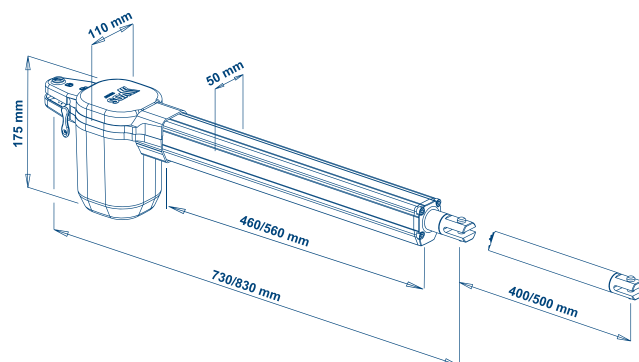

## OPERATORS AND ACCESSORIES

CODE	MODEL	DESCRIPTION
11020	EGO 400 230V*	Irreversible - Stroke 400 mm - Leaf lenght up to 2,50 mt
11021	EGO 500 230V*	Irreversible - Stroke 500 mm - Leaf lenght up to 3 mt
11020/24	EGO 400 24V*	Irreversible - Stroke 400 mm - Leaf lenght up to 2,50 mt
11021/24	EGO 500 24V*	Irreversible - Stroke 500 mm - Leaf lenght up to 3 mt
FC012	FC-MECC	Pair of opening - closing mechanical limit switches
140102	STR	Adjustable rear bracket

 PZ. PALLET  
800x1200x1100 | 30 pz. 270 KG

- \* For EGO for leaf longer than 1,80 mt is suggested the use of an electric lock
- For better radio reception we recommend the use of an external antenna code 210/1
- In the presence of strong wind and cold temperatures, the performance of the actuator can be significantly reduced

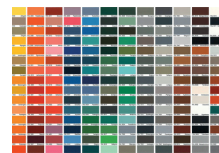

### COLOR SUPPLEMENT

Customize your motor by indicating the RAL code on the order

### KIT CONTENT

The kit contains **1 control board** + accessories



**COD. E105**  
Control board 230V



**COD. F103**  
Control board 24V



**COD. 12/C**  
Pair of photocells



**COD. 23/8**  
LED flashing light



**COD. 198/5**  
Key selector



**COD. E010**  
Remote control



**COD. 165B**  
Warning sign

### KIT 2 LEAVES

CODE	MODEL	DESCRIPTION
11020/2	KIT EGO 400 230V*	Kit 2 leaves for gates up to 5 mt
11021/2	KIT EGO 500 230V*	Kit 2 leaves for gates up to 6 mt
11024/2	KIT EGO 400 24V*	Kit 2 leaves for gates up to 5 mt
11024/4	KIT EGO 500 24V*	Kit 2 leaves for gates up to 6 mt

### KIT 1 LEAF

CODE	MODEL	DESCRIPTION
11020/1	KIT EGO 400 230V*	Kit 1 leaf for gates up to 2,5 mt
11021/1	KIT EGO 500 230V*	Kit 1 leaf for gates up to 3 mt
11024/1	KIT EGO 400 24V*	Kit 1 leaf for gates up to 2,5 mt
11024/3	KIT EGO 500 24V*	Kit 1 leaf for gates up to 3 mt

 PZ. PALLET  
800x1200x1200 | 15 pz. 250 KG

### EXTRA ACCESSORIES

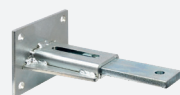

**COD. 140102**  
Adjustable rear bracket



**COD. FC012**  
Pair of mechanical limit switches

# LINEAR 11

## LINEAR ELECTROMECHANICAL OPERATOR 230V - 24V

**i** LEAF LENGHT UP TO 3 MT



INSTRUCTIONS

-  RESIDENTIAL
-  COLLECTIVE
-  POWER SUPPLY 230V - 24V
-  IRREVERSIBLE

### FEATURES

- Sturdy aluminum structure
- Rod stroke MM 400 - MM 500
- Stainless steel rod
- Optional limit switch
- Very quiet operation
- High Performance electric motor
- Thermal cut out 140°
- Manual release with key
- Lithium grease lubrications of mechanical parts against corrosion, oxidation and rust
- 120° opening
- Quick installation with multi-position brackets and cover for brackets in technopolimers
- Anti-squashing system \* (EN 12453)
- Slowing down function \* (EN 12453)
- Power supply 230V - 24V
- Optional kit Battery Back-up

\* Functions guaranteed with VDS electronics devices

### PERFORMANCE REQUIREMENTS

- Operating Cycle SEMI-INTENSIVE 230V, INTENSIVE 24V
- Use frequency 50% (230VAC) - 90% (24VCC)
- Opening time 20 - 25 SEC
- Thrust 2000 N

### TECHNICAL FEATURES

	LINEAR 11 230	LINEAR 11 24
Power supply	230VAC	24VCC
Leaf weight	200 KG	200 KG
Leaf lenght	3 MT	3 MT
Engine RPM	1400 RPM	1500 RPM
Average absorption	1 A	3 A
Absorbed power	200 W	50 W
Standard limit switch	OPTIONAL	OPTIONAL
Condenser	16 UF	-
Motor weight	6,5 KG	6,5 KG
Noise level	< 30 DBA	< 30 DBA
Enviromental conditions	-20 / +55° C	-20 / +55° C
Protection degree	IP55	IP55

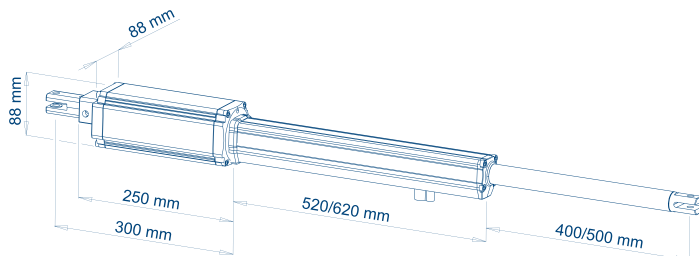

## OPERATORS AND ACCESSORIES

CODE	MODEL	DESCRIPTION
100018	LINEAR11 400 230V*	Irreversible - Stroke 400 mm - Leaf length up to 2,50 mt
100018/5	LINEAR11 500 230V*	Irreversible - Stroke 500 mm - Leaf length up to 3 mt
100018/24	LINEAR11 400 24V*	Irreversible - Stroke 400 mm - Leaf length up to 2,50 mt
100018/7	LINEAR11 500 24V*	Irreversible - Stroke 500 mm - Leaf length up to 3 mt
140102	STR	Adjustable rear bracket

 PZ. PALLET  
800x1200x1100 | 30 pz. 225 KG

- \* For **LINEAR 11** for leaf longer than 1,80 mt is suggested the use of an electric lock
- For better radio reception we recommend the use of an external aerial code 210/1
- In the presence of strong wind and cold temperatures, the performance of the actuator can be significantly reduce

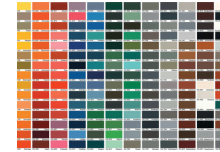

### COLOR SUPPLEMENT

Customize your motor by indicating the RAL code on the order

### KIT CONTENT

The kit contains **1 control board** + accessories



**COD. E105**  
Control board 230V



**COD. F103**  
Control board 24V



**COD. 12/C**  
Pair of photocells



**COD. 23/8**  
LED flashing light



**COD. 198/5**  
Key selector



**COD. E010**  
Remote control



**COD. 165B**  
Warning sign

### KIT 2 LEAVES

CODE	MODEL	DESCRIPTION
100018/1	KIT LINEAR11 400 230V*	Kit 2 leaves for gates up to 5 mt
100018/4	KIT LINEAR11 500 230V*	Kit 2 leaves for gates up to 6 mt
100018/2	KIT LINEAR11 400 24V*	Kit 2 leaves for gates up to 5 mt
100019	KIT LINEAR11 500 24V*	Kit 2 leaves for gates up to 6 mt

### KIT 1 LEAF

CODE	MODEL	DESCRIPTION
10018/1	KIT LINEAR11 400 230V*	Kit 1 leaf for gates up to 2,50 mt
10018/4	KIT LINEAR11 500 230V*	Kit 1 leaf for gates up to 3 mt
10018/2	KIT LINEAR11 400 24V*	Kit 1 leaf for gates up to 2,50 mt
10018/3	KIT LINEAR11 500 24V*	Kit 1 leaf for gates up to 3 mt

 PZ. PALLET  
800x1200x1200 | 15 pz. 250 KG

### EXTRA ACCESSORIES



**COD. 140102**  
Adjustable rear bracket

# IBIS

## ARTICULATED ELECTROMECHANICAL OPERATOR 230V - 24V

**i** LEAF LENGHT UP TO 2,5 MT



INSTRUCTIONS

 RESIDENTIAL

 COLLECTIVE

 POWER SUPPLY 230V - 24V

 IRREVERSIBLE

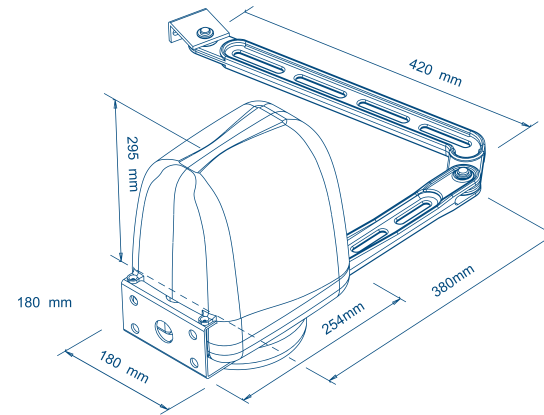

### FEATURES

- Sturdy aluminum, die-casting structure
- Steel and cast gears obtained from solid
- Aluminum articulated anti-shaering arm, powder coated
- Very quiet operation
- High Performance electric motor
- Manual release with custom key
- Predisposition for remote release by cable
- Mechanical limit switch in opening and closing
- Lithium grease lubrications of mechanical parts against corrosion, oxidation and rust
- Opening 120°
- Suited for installation on large pillars
- Single version for right and left door
- Control board with obstacle detection
- Anti-squashing system \* (EN 12453)
- Slowing down function \* (EN 12453)
- Soft start - Soft stop
- Optional kit Battery Back-up
- Power supply 230V - 24V

\* Functions guaranteed with VDS electronics devices

### PERFORMANCE REQUIREMENTS

- Operating Cycle SEMI-INTENSIVE 230V, INTENSIVE 24V
- Use frequency 50% (230 VAC) - 90% (24 VCC)
- Opening and closing time 15 SEC
- Thrust 250 NM

### TECHNICAL FEATURES

	IBIS 230	IBIS 24
Power supply	230VAC	24VAC
Leaf weight	200 KG	150 KG
Leaf lenght	2,5 MT	2,5 MT
Engine RPM	1400 RPM	1800 RPM
Average absorption	1 A	3 A
Absorbed power	250 W	50 W
Condenser	8 UF	-
Motor weight	9,5 KG	9,5 KG
Noise level	< 30 DBA	< 30 DBA
Enviromental conditions	-20 / +55° C	-20 / +55° C
Protection degree	IP44	IP44

LED COURTESY LIGHT

## OPERATORS AND ACCESSORIES

CODE	MODEL	DESCRIPTION
11281	IBIS 230V*	Irreversible - Leaf lenght up to 2,5 mt
11280	IBIS 24V*	Irreversible - Leaf lenght up to 2,5 mt
11280/1	IBIS 24V MASTER *	Irreversible - Leaf lenght up to 2,5 mt Control board and built-in receiver 433 mHz
K028	SLT	Slide lever
855	SBL	Maya external release with 3 m cable
FC011	IBIS-FC	Pair of electric limit switches



PZ. PALLET  
800x1200x1000 | 24 pz. 250 KG

- \* For **IBIS** for leaf longer than 2 mt is suggested the use of an electric lock
- For better radio reception we recommend the use of an external aerial code 210/1
- In the presence of strong wind and cold temperatures, the performance of the actuator can be significantly reduced

### KIT CONTENT

The kit contains **1 control board** + accessories



**COD. E105**  
Control board 230V



**COD. F103**  
Control board 24V



**COD. 12/C**  
Pair of photocells



**COD. 23/8**  
LED flashing light



**COD. 198/5**  
Key selector



**COD. E010**  
Remote control



**COD. 165B**  
Warning sign

### KIT 2 LEAVES

CODE	MODEL	DESCRIPTION
11281/2	KIT IBIS 230V*	Kit 2 leaves for gates up to 5 mt
11280/2	KIT IBIS 24V*	Kit 2 leaves for gates up to 5 mt

### KIT 1 LEAF

CODE	MODEL	DESCRIPTION
11281/3	KIT IBIS 230V*	Kit 1 leaf for gates up to 2,5 mt
11280/3	KIT IBIS 24V*	Kit 1 leaf for gates up to 2,5 mt



PZ. PALLET  
800x1200x1200 | 10 pz. 270 KG

### EXTRA ACCESSORIES



**COD. K028**  
Slide lever



**COD. 855**  
Maya external release  
with 3 m cable



**COD. FC011**  
Pair of electric limit  
switches

# TEKNO

## ARTICULATED ELECTROMECHANICAL OPERATOR 230V

**i** LEAF LENGHT UP TO 3,5 MT



INSTRUCTIONS

RESIDENTIAL

COLLECTIVE

POWER SUPPLY 230V

IRREVERSIBLE

### FEATURES

- Sturdy aluminum, die-casting structure
- Steel and cast gears obtained from solid
- Aluminum articulated anti-shaering arm, powder coated
- Very quiet operation
- High Performance electric motor
- Mechanical release with triangular key
- Electric limit switch in opening and closing
- Lithium grease lubrications of mechanical parts
- against corrosion, oxidation and rust
- Opening 120°
- Suited for installation on large pillars
- Single version for right and left door
- Control panel with obstacle detection
- Anti-squashing system \* (EN 12453)
- Slowing down function \* (EN 12453)
- Power supply 230V

\* Functions guaranteed with VDS electronics devices

### PERFORMANCE REQUIREMENTS

- Operating Cycle SEMI-INTENSIVE
- Use frequency 50% (230VAC)
- Opening and closing time 15 SEC
- Thrust 250 NM

### TECHNICAL FEATURES

Power supply	230VAC
Leaf weight	800 KG
Leaf lenght	3,5 MT
Engine RPM	1400 RPM
Average absorption	1,3 A
Absorbed power	250 W
Standard limit switch	ELETTRICO
Condenser	12,5 UF
Motor weight	8 KG
Noise level	< 30 DBA
Enviromental conditions	-20 / +55° C
Protection degree	IP44

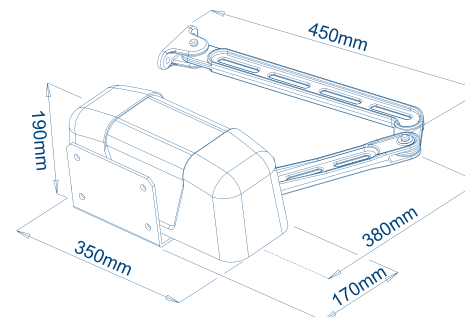

## OPERATOR

CODE	MODEL	DESCRIPTION
100055	TEKNO 230V*	Irreversible - Leaf length up to 3,5 mt

 PZ. PALLET  
800x1200x1000 | 24 pz. 250 KG

- \* For **TEKNO** for leaf longer than 2 mt is suggested the use of an electric lock
- For better radio reception we recommend the use of an external aerial code 210/1
- In the presence of strong wind and cold temperatures, the performance of the actuator can be significantly reduced

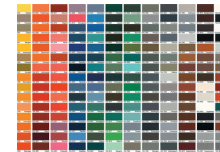

### COLOR SUPPLEMENT

Customize your motor by indicating the RAL code on the order

## KIT CONTENT



**COD. E105**  
Control board 230V



**COD. 12/C**  
Pair of photocells



**COD. 23/8**  
LED flashing light



**COD. 198/5**  
Key selector



**COD. E010**  
Remote control



**COD. 165B**  
Warning sign

### KIT 2 LEAVES

CODE	MODEL	DESCRIPTION
10055/2	KIT TEKNO 230V*	Kit 2 leaves for gates up to 7 mt

### KIT 1 LEAF

CODE	MODEL	DESCRIPTION
10055/1	KIT TEKNO 230V*	Kit 1 leaf for gates up to 3,5 mt

 PZ. PALLET  
10 pz. 300 KG

UNDERGROUND AUTOMATIONS  
FOR **SWING GATES**

# UNDER-V

## UNDERGROUND ELECTROMECHANICAL OPERATOR 230V - 24V

**i LEAF LENGHT UP TO 2,5 MT**



INSTRUCTIONS

RESIDENTIAL

COLLECTIVE

POWER SUPPLY 230V - 24V

IRREVERSIBLE

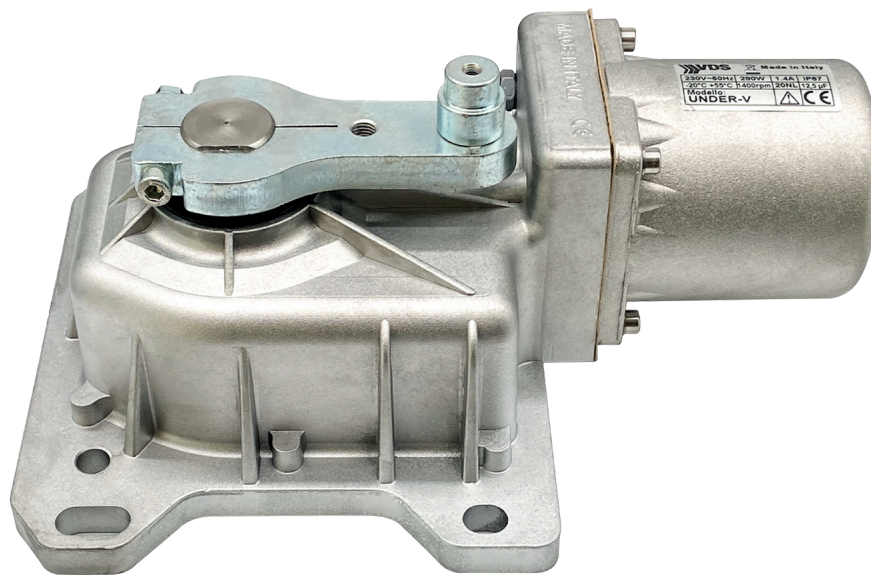

### FEATURES

- Sturdy aluminum, die-casting structure
- Steel and cast gears obtained from solid
- Self-supporting operator, ideal for large gates
- Kit levers 90° opening
- Galvanized steel foundation box
- Very quiet operation
- High Performance electric motor
- Mechanical release for emergency operation with lever supplied
- Shaft drive and scrow in stainless steel
- Lithium grease lubrications of mechanical parts against corrosion, oxidation and rust
- 90° opening
- Anti-squashing system \* (EN 12453)
- Slowing down function \* (EN 12453)
- Optional kit battery back-up
- Power supply 230V - 24V

\* Functions guaranteed with VDS electronics devices

### PERFORMANCE REQUIREMENTS

- Operating Cycle SEMI-INTENSIVE 230VAC, INTENSIVE 24VCC
- Use frequency 50% (230VAC) - 90% (24VCC)
- Opening time 16 SEC
- Torque 250 Nm
- Pinion rotation 90°

### TECHNICAL FEATURES

	UNDER-V 230	UNDER-V 24
Power supply	230VAC	24VCC
Leaf weight	500 KG	500 KG
Leaf lenght	2,5 MT	2,5 MT
Engine RPM	1400	1800
Average absorption	1,4 A	3 A
Absorbed power	280 W	50 W
Condenser	12,5 UF	-
Motor weight	10 KG	10 KG
Noise level	< 30 DBA	< 30 DBA
Enviromental conditions	-20 / +55° C	-20 / +55° C
Protection degree	IP67	IP67

Available with FOUNDATION BOX in galvanized steel and technopolymer with high resistance to corrosion. Predisposition for water drainage pump application.

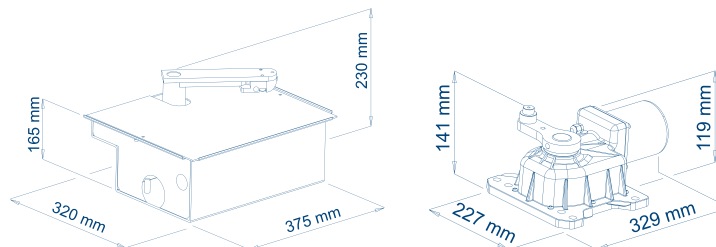

## OPERATORS AND ACCESSORIES

CODE	MODEL	DESCRIPTION
121991/1	UNDER-V 230V	Irreversible - Leaf lenght up to 2,50 mt
121991/24	UNDER-V 24V	Irreversible - Leaf lenght up to 2,50 mt
121992/3	CASSA-Z	Galvanized foundation box complete with levers
121993/1	CASSA-I	Foundation box in stainless steel complete with levers
121992/4	CASSA-PZ	Foundation box in technopolymer, galvanized cover
121992/5	CASSA-PI	Foundation box in technopolymer, stainless steel cover
FC006	FINECORSA	Limit switches
121992/1	180	180 ° opening kit
ST9091	COMP	Adapter curved bracket for compatibility with boxes of other brands
K031	SR	Bracket with lock with custom key



PZ. PALLET  
800x1200x1000 | 32 pz. 490 KG

- For **UNDER-V** for better radio reception we recommend the use of an external aerial code 210/1
- In the presence of strong wind and cold temperatures, the performance of the actuator can be significantly reduced

### KIT CONTENT

The kit contains **1 control board** + accessories



**COD. E105**  
Control board 230V



**COD. F103**  
Control board 24V



**COD. 12/C**  
Pair of photocells



**COD. 23/8**  
LED flashing light



**COD. 198/5**  
Key selector



**COD. E010**  
Remote control



**COD. 165B**  
Warning sign

### KIT 2 LEAVES

CODE	MODEL	DESCRIPTION
121994/1	KIT UNDER-V 230V	Kit 2 leaves for gates up to 5 mt with galvanized boxes
121994/2	KIT UNDER-V 24V	Kit 2 leaves for gates up to 5 mt with galvanized boxes
121994/3	KIT UNDER-V 230V	Kit 2 leaves for gates up to 5 mt without boxes
121994/5	KIT UNDER-V 24V	Kit 2 leaves for gates up to 5 mt without boxes

### KIT 1 LEAF

CODE	MODEL	DESCRIPTION
121994/4	KIT UNDER-V 230V	Kit 1 leaf for gates up to 2,5 mt with galvanized boxes
121994/6	KIT UNDER-V 24V	Kit 1 leaf for gates up to 2,5 mt with galvanized boxes



PZ. PALLET  
800x1200x1200 | 10 pz. 270 KG

### EXTRA ACCESSORIES



**COD. 121992/1**  
180° opening kit



**COD. K031**  
Bracket with lock with custom key



**COD. ST9091**  
Adapter curved bracket for compatibility with other brands

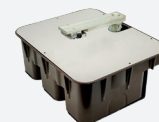

**COD. 121992/5**  
Foundation box in technopolymer, stainless cover



**COD. 121992/3**  
Galvanized foundation box complete with levers



**COD. 121993/1**  
Foundation box in stainless steel complete with levers

# HYDRAULIC AUTOMATIONS FOR **SWING GATES**

# PH | PH1

## LINEAR HYDRAULIC OPERATOR 230V

**i** PH1 IRREVERSIBLE: LEAF LENGTH UP TO 5 MT  
PH REVERSIBLE: LEAF LENGTH UP TO 6 MT



INSTRUCTIONS

RESIDENTIAL

COLLECTIVE

POWER SUPPLY 230V

REVERSIBLE

IRREVERSIBLE

### FEATURES

- Sturdy aluminum structure
- Stroke MM 270 - MM 390
- Chromed steel rod with uniball ball joint
- Very quiet operation
- Electric motor in oil bath
- 140° thermal protection
- Manual release with key
- 90° opening
- Quick installation with multi-position brackets
- Hydraulic slowdown adjustment in closing
- Power supply 230V
- PH needs electric lock
- No limit switches

### PERFORMANCE REQUIREMENTS

- Operating Cycle INTENSIVE
- Use frequency 90%
- Thrust 1850/2240 N

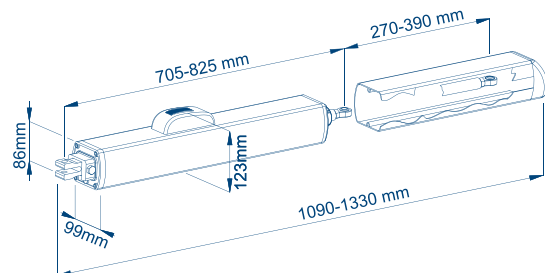

### TECHNICAL FEATURES

	PH1 270	PH 270	PH 390	PH1 390
Power supply	230VAC	230VAC	230VAC	230VAC
Leaf weight	500 KG	500 KG	500 KG	500 KG
Leaf length	1,80 MT	3 MT	6 MT	5 MT
Engine RPM	1400 RPM	1400 RPM	1400 RPM	1400 RPM
Average absorption	1 A	1 A	1,9 A	1,9 A
Absorbed power	250 W	250 W	350 W	350 W
Standard limit switch	NO	NO	NO	NO
Condenser	10 UF	10 UF	10 UF	10 UF
Motor weight	9 KG	9 KG	10 KG	10 KG
Noise level	< 30 DBA	< 30 DBA	< 30 DBA	< 30 DBA
Environmental conditions	-25 / +70° C	-25 / +70° C	-25 / +70° C	-25 / +70° C
Protection degree	IP55	IP55	IP55	IP55

## OPERATORS

CODE	MODEL	DESCRIPTION	
121913	PH1270	Irreversible - Stroke 270 mm - Leaf lenght up to 1,80 mt	●
121927	PH270*	Reversible - Stroke 270 mm - Leaf lenght up to 3 mt	●
12384	PH1390	Irreversible - Stroke 390 mm - Leaf lenght up to 5 mt	●
12384/1	PH390*	Reversible - Stroke 390 mm - Leaf lenght up to 6 mt	●



PZ. PALLET  
800x1200x1100 | 36 pz. 460 KG

- \* For PH for leaf is always required the use of an electric lock
- For better radio reception we recommend the use of an external aerial code 210/1
- In the presence of strong wind and cold temperatures, the performance of the actuator can be significantly reduced

## KIT CONTENT



**COD. E105**  
Control board 230V



**COD. 12/C**  
Pair of photocells



**COD. 23/8**  
LED flashing light



**COD. 198/5**  
Key selector



**COD. E010**  
Remote control



**COD. 165B**  
Warning sign

## KIT 2 LEAVES

CODE	MODEL	DESCRIPTION	
112570	KIT PH1270	Kit 2 leaves for gates up to 3,60 mt	●
112570/1	KIT PH270*	Kit 2 leaves for gates up to 6 mt	●
12384/2	KIT PH1390	Kit 2 leaves for gates up to 10 mt	●
12384/3	KIT PH390*	Kit 2 leaves for gates up to 12 mt	●

## KIT 1 LEAF

CODE	MODEL	DESCRIPTION	
112570/2	KIT PH270	Kit 1 leaf for gates up to 1,80 mt	●
112570/3	KIT PH1270*	Kit 1 leaf for gates up to 3 mt	●
12384/4	KIT PH1390	Kit 1 leaf for gates up to 5 mt	●
12384/5	KIT PH390*	Kit 1 leaf for gates up to 6 mt	●



PZ. PALLET  
800x1200x1200 | 14 pz. 390 KG

# PHV

## LINEAR HYDRAULIC OPERATOR 230V

**i** PHV IRREVERSIBLE: LEAF LENGTH UP TO 4 MT  
 PHV REVERSIBLE: LEAF LENGTH UP TO 7 MT



INSTRUCTIONS

- RESIDENTIAL
- COLLECTIVE
- POWER SUPPLY 230V
- REVERSIBLE
- IRREVERSIBLE

### FEATURES

- Sturdy aluminum and die-casting structure
- Stroke MM 242 (PHV 240) - MM 362 (PHV 360)
- Steel rod rectified and chromed MM 20
- Very quiet operation
- Electric motor in oil bath
- Valve device for selection between reversibility or locking
- Hydraulic adjustment for thrust
- Hydraulic slowdown adjustment in closing
- Aluminum rod cover included
- Manual release with key
- 90° opening
- Quick installation with multi-position brackets
- Power supply 230V
- Limit switches in opening

### PERFORMANCE REQUIREMENTS

- Operating Cycle INTENSIVE
- Use frequency 100%
- Thrust 6252/7793 N

### TECHNICAL FEATURES

	PHV 240	PHV 360
Power supply	230VAC	230VAC
Leaf weight	600 KG	800 KG
Leaf length	4 MT	7 MT
Engine RPM	50 BAR	50 BAR
Average absorption	1,1 A	1,3 A
Absorbed power	276 W	280 W
Standard limit switch	OPTIONAL	OPTIONAL
Condenser	16 UF	16 UF
Motor weight	12 KG	13,5 KG
Noise level	< 30 DBA	< 30 DBA
Enviromental conditions	-15 / +80° C	-15 / +80° C
Protection degree	100	100

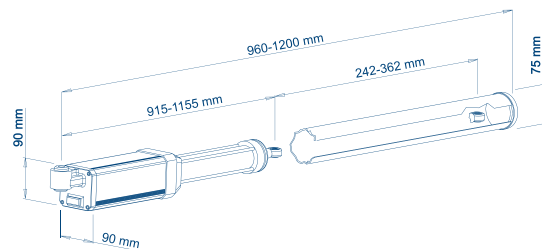

## OPERATORS AND ACCESSORIES

CODE	MODEL	DESCRIPTION
100021	PHV 240*	Irreversible / Reversible - Stroke 242 MM - Leaf length up to 4 mt
100022	PHV 360**	Irreversible / Reversible - Stroke 362 MM - Leaf length up to 7 mt
SD1	FC	Mechanical limit switch



PZ. PALLET  
800x1200x1100 | 20 pz. 280 KG

- \* For PHV 240 for leaves longer than 1,80 meters, the use of the electric lock is always required
- \*\* For PHV 360 for leaves longer than 2,50 meters, the use of the electric lock is always required
- For better radio reception we recommend the use of an external aerial code 210/1
- In the presence of strong wind and cold temperatures, the performance of the actuator can be significantly reduced

### KIT CONTENT



COD. E105  
Control board 230V



COD. 12/C  
Pair of photocells



COD. 23/8  
LED flashing light



COD. 198/5  
Key selector



COD. E010  
Remote control



COD. 165B  
Warning sign

### KIT 2 LEAVES

CODE	MODEL	DESCRIPTION
112581/1	KIT PHV 240*	Kit 2 leaves for gates up to 8 mt
112581/2	KIT PHV 360**	Kit 2 leaves for gates up to 14 mt

### KIT 1 LEAF

CODE	MODEL	DESCRIPTION
112581/3	KIT PHV 240*	Kit 1 leaf for gates up to 4 mt
112581/4	KIT PHV 360**	Kit 1 leaf for gates up to 7 mt



PZ. PALLET  
800x1200x1200 | 8 pz. 270 KG

### EXTRA ACCESSORIES



COD. SD1  
Mechanical limit switch

The background features a solid blue field with a large, diagonal orange shape on the left side, creating a modern, abstract design.

# AUTOMATIONS FOR **SLIDING GATES**

Automations for Sliding Gates

# SIMPLY OPERATOR 230V - 24V

**GATES UP TO 600 KG**



Available with  
MECHANICAL OR  
MAGNETIC LIMIT  
SWITCH

Available with  
FAST VERSION  
220V/110V 20 MT/MIN



INSTRUCTIONS

-  RESIDENTIAL
-  COLLECTIVE
-  POWER SUPPLY 230V - 24V

**700.000  
UNITS SOLD**

## FEATURES

- Structure in die-cast aluminum, powder painted
- Steel and cast gears obtained from solid
- Lithium grease lubrications of mechanical parts against corrosion, oxidation and rust
- Very quiet operation
- High Performance electric motor
- Lever release with custom key
- Available with or without Encoder
- Electronic torque control
- Pre-wiring and easy programming software
- Available with or without control unit
- Control unit box with air-stop seal against moisture and insects
- Anti-squashing system \* (EN 12453)
- Slowing down function \* (EN 12453)
- Optional kit battery back-up
- Power supply 230V - 24V

\* Functions guaranteed with VDS electronics devices

## PERFORMANCE REQUIREMENTS

- Operating Cycle SEMI-INTENSIVE 230V, INTENSIVE 24V
- Use frequency 50% (230VAC) - 80% (24VCC)
- Speed 10 MT/MIN (230VAC) - 12 MT/MIN (24VCC)

## TECHNICAL FEATURES

	SIMPLY 230	SIMPLY 24
Power supply	230VAC	24VAC
Leaf weight	600 KG	400/600 KG
Pinion	M4-Z12	M4-Z12
Engine RPM	1400 RPM	1800 RPM
Average absorption	1,3 A	3 A
Absorbed power	250 W	50 W
Condenser	12,5 UF	-
Motor weight	8 KG	8 KG
Noise level	< 30 DBA	< 30 DBA
Enviromental conditions	-20 / +55° C	-20 / +55° C
Protection degree	IP44	IP44

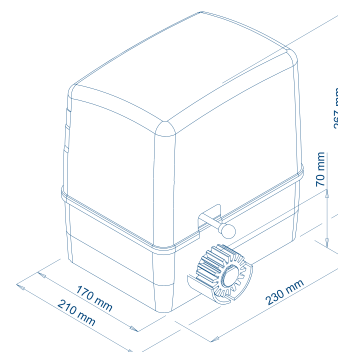

## OPERATORS AND ACCESSORIES

CODE	MODEL	DESCRIPTION
100010	SIMPLY 230V*	Operator - Without control board
100010/1	SIMPLY 230V CQ*	Operator - Control board and built-in receiver 433 mHz
100011	SIMPLY 24V*	Operator - Without control board
100011/1	SIMPLY 24V CQ*	Operator - Control board and built-in receiver 433 mHz
140063	CPT	Fixing plate
FC003	FCM	Extra for magnetic limit switch
EN001	EN CDR	Extra for encoder
CPT-B	VERS.B	Adapter fixing plate for sliding motor B
CPT-C	VERS.C	Adapter fixing plate for sliding motor C
CPT-F	VERS.F	Adapter fixing plate for sliding motor F
CPT-N	VERS.N	Adapter fixing plate for sliding motor N

 PZ. PALLET  
800x1200x1600 | 50 pz. 410 KG

- \* Fixing plate not included
- For better radio reception we recommend the use of an external aerial code 210/1
- In presence of strong wind and cold temperatures, the performance of the actuator can be significantly reduced

### KIT CONTENT

The kit contains **1 control board** + accessories

 PZ. PALLET  
800x1200x1300 | 32 pz. 330 KG



**COD. E102**  
Control board 230V



**COD. E103**  
Control board 24V



**COD. 12/C**  
Pair of photocells



**COD. 23/8**  
LED flashing light



**COD. 198/5**  
Key selector



**COD. E010**  
Remote control



**COD. 165B**  
Warning sign

CODE	MODEL	DESCRIPTION
100010/6	KIT SIMPLY 230V	Kit for gates up to 600 kg
100010/7	KIT SIMPLY 24V	Kit for gates up to 600 kg
100010/2	KIT SIMPLY 230V 2M	Kit 2 leaves for gates up to 600 kg

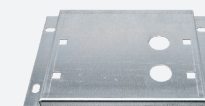

**COD. 140063**  
Fixing plate

### EXTRA ACCESSORIES



**COD. FC003**  
Magnetic limit switch



**COD. 140063**  
Fixing plate



**COD. CPT-B**  
Adapter plate for compatibility with other brands



**COD. CPT-C**  
Adapter plate for compatibility with other brands



**COD. CPT-F**  
Adapter plate for compatibility with other brands



**COD. CPT-N**  
Adapter plate for compatibility with other brands

Automations for Sliding Gates

# GEKO OPERATOR 230V

**i** GATES UP TO 400 KG



INSTRUCTIONS



RESIDENTIAL



COLLECTIVE



POWER SUPPLY 230V

## FEATURES

- Structure in die-cast aluminum, powder painted
- Steel and cast gears obtained from solid
- Lithium grease lubrications of mechanical parts against corrosion, oxidation and rust
- Very quiet operation
- High Performance electric motor
- Lever release with custom key
- Electronic torque control
- Pre-wiring and easy programming software
- Available with or without control unit
- Control unit box with air-stop seal against moisture and insects
- Anti-squashing system \* (EN 12453)
- Power supply 230V

\* Functions guaranteed with VDS electronics devices

## PERFORMANCE REQUIREMENTS

- Operating Cycle SEMI-INTENSIVE 230VAC
- Use frequency 50% (230VAC)
- Speed 10 MT/MIN (230VAC)

## TECHNICAL FEATURES

Power supply	230VAC
Leaf weight	400 KG
Pinion	M4-Z12
Engine RPM	1400 RPM
Average absorption	1,3 A
Absorbed power	250 W
Condenser	10 UF
Motor weight	8 KG
Noise level	< 30 DBA
Enviromental conditions	-20 / +55° C
Protection degree	IP44

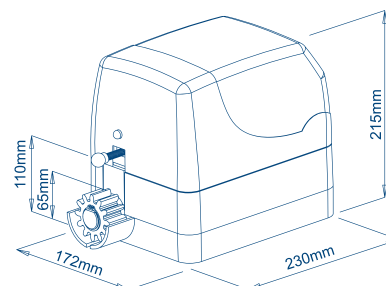

## OPERATORS AND ACCESSORIES

CODE	MODEL	DESCRIPTION
11090	GEKO 230V	Operator - Without control board
11090/1	GEKO 230V CQ	Operator - Control board and built-in receiver 433 mHz
CPT04	CPT	Fixing plate



PZ. PALLET  
80x1200x1600 | 50 pz. 410 KG

### KIT CONTENT

The kit contains **1 control board** + accessories



PZ. PALLET  
80x1200x1300 | 32 pz. 330 KG



**COD. E102**  
Control board 230V



**COD. 12/C**  
Pair of photocells



**COD. 23/8**  
LED flashing light



**COD. 198/5**  
Key selector



**COD. E010**  
Remote control



**COD. 165B**  
Warning sign

CODE	MODEL	DESCRIPTION
11090/2	KIT GEKO 230V	Kit for gates up to 400 kg

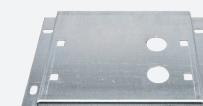

**COD. CPT04**  
Fixing plate

### EXTRA ACCESSORIES

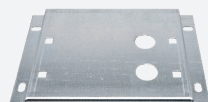

**COD. CPT04**  
Fixing plate

Automations for Sliding Gates

# CARRERA

## OPERATOR 230V - 24V

**GATES UP TO 1000 KG**



INSTRUCTIONS

-  RESIDENTIAL
-  COLLECTIVE
-  POWER SUPPLY 230V - 24V

### FEATURES

- Structure in die-cast aluminum, powder painted
- Steel and cast gears obtained from solid
- Lithium grease lubrications of mechanical parts against corrosion, oxidation and rust
- Very quiet operation
- High Performance electric motor
- Lever release with custom key
- Available with or without Encoder
- Electronic torque control
- Pre-wiring and easy programming software
- Available with or without control board
- Control board box with air-stop seal against moisture and insects
- Anti-squashing system \* (EN 12453)
- Slowing down function \* (EN 12453)
- Optional kit battery back-up
- Power supply 230V - 24V

\* Functions guaranteed with VDS electronics devices

### PERFORMANCE REQUIREMENTS

- Operating Cycle SEMI-INTENSIVE 230V, INTENSIVE 24V
- Use frequency 50% (230VAC) - 80% (24VCC)
- Speed 10 MT/MIN (230VAC) - 12 MT/MIN (24VCC)

### TECHNICAL FEATURES

	CARRERA 800-230	CARRERA 800-24	CARRERA 1000-230
Power supply	230VAC	24VCC	230VAC
Leaf weight	800 KG	800 KG	1000 KG
Pinion	M4-Z16	M4-Z16	M4-Z16
Engine RPM	1400 RPM	1800 RPM	1400 RPM
Average absorption	2 A	3 A	2 A
Absorbed power	330 W	50 W	330 W
Condenser	10 UF	-	12,5 UF
Motor weight	9 KG	9 KG	9 KG
Noise level	< 30 DBA	< 30 DBA	< 30 DBA
Enviromental conditions	-20 / +55° C	-20 / +55° C	-20 / +55° C
Protection degree	IP44	IP44	IP44

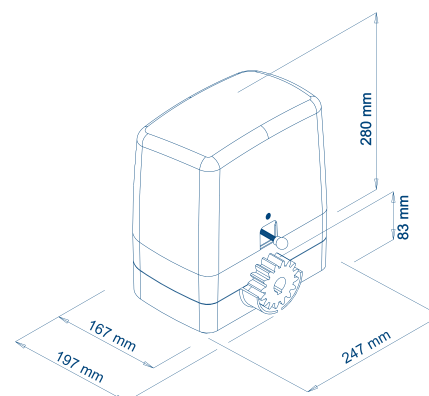

Available with  
MECHANICAL OR  
MAGNETIC LIMIT  
SWITCH

Available with  
FAST VERSION  
220V/110V 20 MT/MIN

## OPERATORS AND ACCESSORIES

CODE	MODEL	DESCRIPTION
100600	CARRERA 800 230V*	Operator - Up to 800 kg - Without control board
100609/E	CARRERA 800 24V C/ ENCDR*	Operator - Up to 800 kg - Without control board
100601	CARRERA 1000 230V*	Operator - Up to 1000 kg - Without control board
100602	CARRERA 800 230V CQ*	Operator - Up to 800 kg - Control board and built-in receiver 433 mHz
100609	CARRERA 800 24V CQ*	Operator - Up to 800 kg - Control board and built-in receiver 433 mHz
100604	CARRERA 1000 230V CQ*	Operator - Up to 1000 kg - Control board and built-in receiver 433 mHz
100607	CPT	Fixing plate
FC004	FCM	Extra for magnetic limit switch
EN001	ENCDR	Extra for encoder



PZ. PALLET  
800x1200x1600 | 40 pz. 400 KG

- \* Fixing plate not included
- For better radio reception we recommend the use of an external aerial code 210/1
- In presence of strong wind and cold temperatures, the performance of the actuator can be significantly reduced

### KIT CONTENT

The kit contains **1 control board** + accessories



PZ. PALLET  
800x1200x1500 | 32 pz. 430 KG



**COD. E102**  
Control board 230V



**COD. E103**  
Control board 24V



**COD. 12/C**  
Pair of photocells



**COD. 23/8**  
LED flashing light



**COD. 198/5**  
Key selector



**COD. E010**  
Remote control



**COD. 165B**  
Warning sign

CODE	MODEL	DESCRIPTION
100605	KIT CARRERA 800 230V	Kit for gates up to 800 kg
10606	KIT CARRERA 800 24V	Kit for gates up to 800 kg
100606	KIT CARRERA 1000 230V	Kit for gates up to 1000 kg

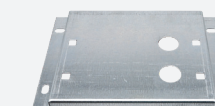

**COD. 140607**  
Fixing plate

### EXTRA ACCESSORIES



**COD. FC004**  
Magnetic limit switch



**COD. 140607**  
Fixing plate

Automations for Sliding Gates

# AG FUTURE OPERATOR 230V - 380V

**GATES UP TO 1800 KG**



INSTRUCTIONS

RESIDENTIAL

COLLECTIVE

POWER SUPPLY 230V - 380V

IN OIL BATH



## FEATURES

- Structure in die-cast aluminum, powder painted
- Steel and cast gears obtained from solid
- Stator and mechanical parts in oil bath - except 800 kg version, grease lubricated
- Available with or without control board
- Control board with built-in receiver and antenna, control unit box with air-stop seal against moisture and insects
- Pre-wiring and easy programming software
- High Performance electric motor
- Manual lever release with custom key
- Electronic torque control
- Very quiet operation
- Anti-squashing system \* (EN 12453)
- Slowing down function \* (EN 12453)
- The 1800 kg three-phase version comes with a control board with soft start and stop function
- Power supply 230V - 380V

\* Functions guaranteed with VDS electronics devices

## PERFORMANCE REQUIREMENTS

- Operating Cycle SEMI-INTENSIVE 230V, INTENSIVE 380V
- Use frequency 50% (230VAC) - 80% (380VAC)
- Speed 8 MT/MIN (230VAC) - 8 MT/MIN (380VAC)

## TECHNICAL FEATURES

	AG FUTURE 800 KG	AG FUTURE 1000 KG	AG FUTURE 1600 KG	AG FUTURE 1600 KG TRIFASE	AG FUTURE 1600 KG TRIFASE INVERTER
Power supply	230VAC	230VAC	230VAC	380VAC	230VAC
Leaf weight	800 KG	1000 KG	1600 KG	1600 KG	1800 KG
Pinion	M4-Z16	M4-Z16	M4-Z16	M4-Z16	M4-Z16
Engine RPM	1400 RPM	1400 RPM	1400 RPM	1400 RPM	1400 RPM
Average absorption	1,5 A	1,7 A	1,8 A	1,5 A	1,5 A
Absorbed power	280 W	330 W	360 W	500 W	400 W
Condenser	12,5 UF	16 UF	18 UF	-	-
Motor weight	13 KG	13 KG	13 KG	13 KG	13 KG
Noise level	< 30 DBA	< 30 DBA	< 30 DBA	< 30 DBA	< 30 DBA
Environmental conditions	-20 / +55° C	-20 / +55° C	-20 / +55° C	-20 / +55° C	-20 / +55° C
Protection degree	IP44	IP44	IP44	IP44	IP44

Available with  
MECHANICAL OR  
MAGNETIC LIMIT  
SWITCH

Available with  
FAST VERSION  
220V/110V 20 MT/MIN

## OPERATORS AND ACCESSORIES

CODE	MODEL	DESCRIPTION
11068	AG F 800 KG**	Operator - Up to 800 kg - Without control board
11065	AG F 1000 KG*	Operator - Up to 1000 kg - Without control board
11066	AG F 1600 KG*	Operator - Up to 1600 kg - Without control board
11067	AG F 1600KG TRIFASE 380V*	Operator - Up to 1600 kg - Without control board
11068/1	AG F 800 KG CQ**	Operator - Up to 800 kg - With control board receiver
11065/1	AG F 1000 KG CQ*	Operator - Up to 1000 kg - With control board receiver
11066/1	AG F 1600 KG CQ*	Operator - Up to 1600 kg - With control board receiver
11069/1	AG F 1800 KG TRIFASE 230V CQ	Operator - Up to 1800 kg - With inverter control board - Witht receiver
CPT02	CPT	Fixing plate
FC005	AG FUTUREFCM	Extra for magnetic limit switch



PZ. PALLET  
800x1200x1600 | 35 pz. 490 KG

- \* Fixing plate not included
- For better radio reception we recommend the use of an external aerial code 210/1
- In presence of strong wind and cold temperatures, the performance of the actuator can be significantly reduced

### KIT CONTENT

The kit contains **1 control board** + accessories



PZ. PALLET  
800x1200x1000 | 24 pz. 432 KG



**COD. E102**  
Control board 230V



**COD. E107**  
Control board 380V



**COD. 12/C**  
Pair of photocells



**COD. 23/8**  
LED flashing light



**COD. 198/5**  
Key selector



**COD. E010**  
Remote control



**COD. 165B**  
Warning sign

CODE	MODEL	DESCRIPTION
11068/2	KIT AG F 800 KG*	Kit for gates up to 800 kg
11065/2	KIT AG F 1000 KG*	Kit for gates up to 1000 kg
11066/2	KIT AG F 1600 KG*	Kit for gates up to 1600 kg



**COD. CPT02**  
Fixing plate

### EXTRA ACCESSORIES



**COD. FC005**  
Magnetic limit switch



**COD. CPT02**  
Fixing plate

Automations for Sliding Gates

# AT PLUS

## OPERATOR 230V - 380V

**GATES UP TO 2500 KG**



INSTRUCTIONS

 RESIDENTIAL

 COLLECTIVE

 POWER SUPPLY 230V - 380V

 IN OIL BATH

### FEATURES

- Structure in die-cast aluminum, powder painted
- Steel and cast gears obtained from solid
- Stator and mechanical parts in oil bath
- Available with or without control board
- Control unit with built-in receiver and antenna, control board box with air-stop seal against moisture and insects
- Pre-wiring and easy programming software
- High Performance electric motor
- Mechanical limit switch
- Manual lever release with custom key
- Electronic torque control
- Very quiet operation
- Anti-squashing system \* (EN 12453)
- Slowing down function \* (EN 12453)
- Power supply 230V - 380V

\* Functions guaranteed with VDS electronics devices

### PERFORMANCE REQUIREMENTS

- Operating Cycle INTENSIVE 230VAC, INTENSIVE 380VAC
- Use frequency 90% (230VAC) - 90% (380VAC)
- Speed 9,6 MT/MIN (230VAC) - 9,6 MT/MIN (380VAC)

### TECHNICAL FEATURES

	AT PLUS 2500	AT PLUS 2500 TRIPHASE
Power supply	230VAC	380VAC
Leaf weight	2500 KG	2500 KG
Pinion	M4-Z16	M4-Z16
Engine RPM	1400 RPM	1400 RPM
Average absorption	2,4 A	2,4 A
Absorbed power	650 W	650 W
Condenser	12,5 UF	-
Motor weight	18 KG	18 KG
Noise level	< 30 DBA	< 30 DBA
Environmental conditions	-20 / +55° C	-20 / +55° C
Protection degree	IP44	IP44

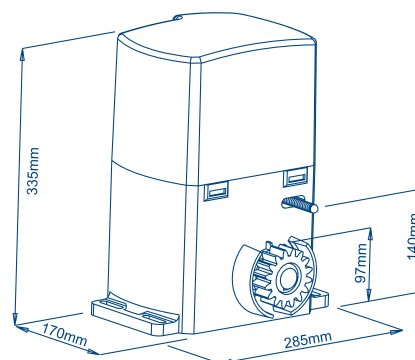

## OPERATORS

CODE	MODEL	DESCRIPTION
A3500	AT PLUS 230V	Operator - Up to 2500 kg - Fixing plate - Without control board
A3500/1	AT PLUS TRIPHASE 380V	Operator - Up to 2500 kg - Three-phase 380V - Fixing plate - Without control board
10035/1	AT PLUS 230V CQ	Operator - Up to 2500 kg - Fixing plate - Control board and built-in receiver 433 mHz



PZ. PALLET  
800x1200x1600 | 26 pz. 460 KG

- For better radio reception we recommend the use of an external aerial code 210/1
- In presence of strong wind and cold temperatures, the performance of the actuator can be significantly reduced

### KIT CONTENT

The kit contains **1 control board** + accessories



**COD. E102**  
Control board 230V



**COD. E107**  
Control board 380V



**COD. 12/C**  
Pair of photocells



**COD. 23/8**  
LED flashing light



**COD. 198/5**  
Key selector



**COD. E010**  
Remote control



**COD. 165B**  
Warning sign

CODE	MODEL	DESCRIPTION
10035	KIT AT PLUS 2500	Kit for gates up to 2500 kg
10035/T	KIT AT PLUS 2500 380V	Kit for gates up to 2500 kg



PZ. PALLET  
800x1200x1000 | 25 pz. 450 KG

Automations for Sliding Gates

# TOM OPERATOR 230 $\Delta$ - 400Y VAC

**GATES UP TO 5000 KG**



INSTRUCTIONS



COLLECTIVE



POWER SUPPLY 230V - 380V

## FEATURES

- Structure in painted steel and stainless steel, cover in ABS
- Steel and bronze gears obtained from solid
- Air-cooled motor and gearbox in oil bath
- Available with or without control unit
- External control unit with watertight box
- High Performance electric motor
- Mechanical limit switch
- Manual release with hex key
- Very quiet operation
- Motor not provided with clutch, provide with safety equipment
- Motor door safety microswitch
- Three-phase motor 230 - 400Y VAC

\* Functions guaranteed with VDS electronics devices



Toothed pinion suitable  
for MODULE 4 RACKS

## PERFORMANCE REQUIREMENTS

- Operating Cycle INTENSIVE
- Use frequency 90%
- Speed 8 MT/MIN

## TECHNICAL FEATURES

Power supply	230 $\Delta$ - 400Y VAC
Leaf weight	4000 KG - 380V* 5000 KG - TRIPHASE INVERTER
Pinion	Z20
Engine RPM	1400 RPM
Average absorption	2,5 A
Absorbed power	750 W
Motor weight	40 KG
Noise level	< 30 DBA
Enviromental conditions	-25 / +70° C
Protection degree	IP54
Limit switch	ELECTOMECHANICAL

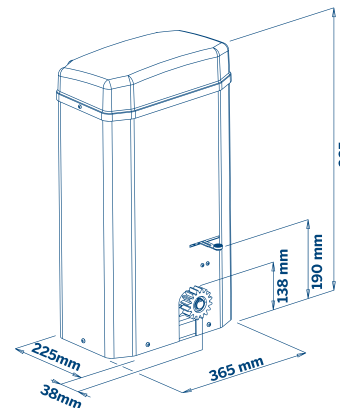

## OPERATORS AND ACCESSORIES

CODE	MODEL	DESCRIPTION
11040	TOM 230 - 400Y - M4	Operator - Up to 5000 kg - Without contro board - With pinion M4
11040/1	TOM 230 - 400Y - M6	Operator - Up to 5000 kg - Without contro board - With pinion M6
121110	CPT	Fixing plate
Q100	INVERTER	Contro board 230V - Inverter - Without receiver
E107	EURO 380 M1	Contro board 230/380VAC
E142	SRM	External radio receiver 433 mHz 1 channel - With box 12/24V
AC01-100	100A	Galvanized cabinet with key for control board
AC01-200VA	200V	Support for control board



PZ. PALLET  
800x1200x70 | 6 pz. 300 KG

- In presence of strong cold temperatures, the performance of the actuator can be significantly reduced

### EXTRA ACCESSORIES



**COD. 121110**  
Fixing plate

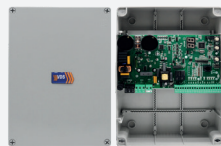

**COD. Q100**  
Control board 230V Inverter



**COD. E107**  
Control board 230V - 380V



**COD. AC01-100**  
Galvanized cabinet with key  
for control board



**COD. AC01-200VA**  
Support for control board



**COD. E142**  
External radio receiver  
433mHz



**COD. 23/8**  
LED flashing light



**COD. 12/C**  
Pair of photocells



**COD. 165B**  
Warning sign



**COD. E010**  
Remote control



**COD. 198/5**  
Key selector

Automations for Sliding Gates

# SLIM VULCAN

## OPERATOR 230V - 24V

**GATES UP TO 250 KG**



Suitable for application  
inside pillars



INSTRUCTIONS

 RESIDENTIAL

 POWER SUPPLY 230V - 24V

### FEATURES

- Operator 24V with Encoder - Operator 230V without Encoder
- It works also without mechanical limit switch
- High Performance electric motor
- Very quiet operation
- Control board with built-in receiver and antenna, control board box with air-stop seal against moisture and insects
- Pre-wiring and easy programming software
- Manual release with hex key
- Electronic torque control
- Anti-squashing system \* (EN 12453)
- Slowing down function \* (EN 12453)
- Anti blackout battery kit
- Power supply 230V - 24V

\* Functions guaranteed with VDS electronics devices

### PERFORMANCE REQUIREMENTS

- Operating Cycle SEMI-INTENSIVE 230V, INTENSIVE 24V
- Emergency release with key
- Speed 10 MT/MIN (230VAC) - 10 MT/MIN (24VCC)

### TECHNICAL FEATURES

	SLIM VULCAN 230	SLIM VULCAN 24
Power supply	230VAC	24VCC
Leaf weight	250 KG	200 KG
Engine RPM	1400 RPM	1800 RPM ENCODER
Average absorption	1 A	3 A
Absorbed power	200 W	50 W
Condenser	12,5 UF	-
Motor weight	4,5 KG	4 KG
Noise level	< 30 DBA	< 30 DBA
Limit switch	OPTIONAL	OPTIONAL
Protection degree	IP44	IP44

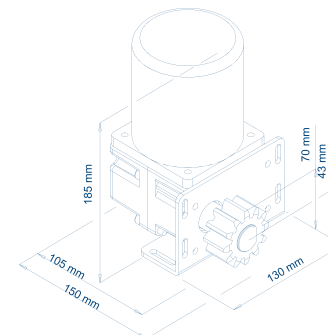
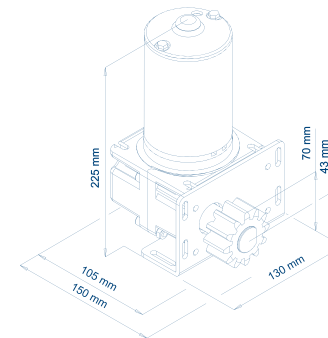

## OPERATORS AND ACCESSORIES

CODE	MODEL	DESCRIPTION
10009/P	SLIM 230V	Operator - Up to 350 kg - Fixing plate - Without control board
10009/E	SLIM 230V	Operator - Up to 350 kg - Fixing plate - Encoder - Without control board
10081/ENC	SLIM 24V	Operator - Up to 350 kg - Fixing plate - Encoder - Without control board
FC001	FC MEC	Mechanical limit switch
FC002	FC MAG	Magnetic limit switch

 PZ. PALLET  
800x1200x1600 | 50 pz. 230 KG

- For better radio reception we recommend the use of an external aerial code 210/1
- In presence of strong cold temperatures, the performance of the actuator can be significantly reduced

### KIT CONTENT

The kit contains **1 control board** + accessories

 PZ. PALLET  
800x1200x1000 | 25 pz. 450 KG



**COD. E102**  
Control board 230V



**COD. E103**  
Control board 24V



**COD. 12/C**  
Pair of photocells



**COD. 23/8**  
LED flashing light



**COD. 198/5**  
Key selector



**COD. E010**  
Remote control



**COD. 165B**  
Warning sign

COD	MOD	DESCRIZIONE	PREZZO
10009/K	KIT SLIM 230	Kit Slim Vulcan 230V - mechanical limit switch	
10009/KE	KIT SLIM 230E	Kit Slim Vulcan 230V with Encoder-mechanical limit switch	
10081/KE	KIT SLIM 24E	Kit Slim Vulcan 24V with Encoder - mechanical limit switch	
10009/kM	SLIM 230	Kit Slim Vulcan 230V - with magnetic limit switch	
10009/keM	SLIM 230E	Kit Slim Vulcan 230V with Encoder - magnetic limit switch	
10081/keM	SLIM 24E	Kit Slim Vulcan 24V with Encoder-magnetic limit switch	

### EXTRA ACCESSORIES



**COD. FC002**  
Magnetic limit switch



**COD. FC001**  
Mechanical limit switch



The background features a solid blue field with a large, diagonal orange shape on the left side, creating a modern, abstract design.

# AUTOMATIONS FOR **GARAGE DOORS**

Automations for Garage Doors

# UTILE

## TOWING ELECTROMECHANICAL OPERATOR 24V

**i DOOR WEIGHT UP 100 KG**



INSTRUCTIONS



RESIDENTIAL



COLLECTIVE



POWER SUPPLY 24V

### FEATURES

- Operator Encoder
- Suitable for selectional and counterweight doors (with curved arm)
- Galvanized iron or aluminum guide with pre-assembled chain or belt
- Lithium grease lubrications of mechanical parts against corrosion, oxidation and rust
- High Performance electric motor
- Very quiet operation
- Limit switches / Encoder
- Magnetic contact for pedestrian
- Pre-wiring and easy programming software
- Control board with built-in receiver and antenna
- Electronic torque control
- Anti-squashing system \* (EN 12453)
- Slowing down function \* (EN 12453)
- Power supply 24V

\* Functions guaranteed with VDS electronics devices

### PERFORMANCE REQUIREMENTS

	UTILE 70KG	UTILE 100KG
Power supply	24VCC	24VCC
Thrust	700 N	1000 N
Door weight	10 MQ	14 MQ
Engine RPM	220 RPM	220 RPM
Average absorption	0,7 A	1,2 A
Pinion	1/2"X1/8 Z9 PASSO 8 Z12	1/2"X1/8 Z9 PASSO 8 Z12
Motor weight	4 KG	4 KG
Noise level	< 30 DBA	< 30 DBA
Enviromental conditions	-20 / +55° C	-20 / +55° C
Protection degree	IP30	IP30

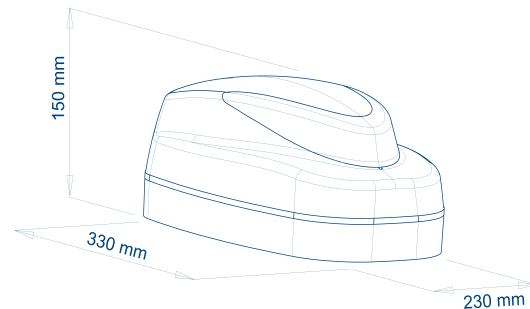

Courtesy light with LOW CONSUMPTION LED

## OPERATORS

CODE	MODEL	DESCRIPTION
11085	UTILE 70 KG	Operator-Control board-Belt-Iron guide 3mt
11084	UTILE 70 KG	Operator Control board-Chain-Iron guide 3mt
11087	UTILE 70 KG	Operator-Control board-Belt-Aluminum guide 1,5mt +1,5mt
11086	UTILE 70 KG	Operator-Control board-Chain-Aluminum guide 1,5mt+1,5mt
11085/2	UTILE 70 KG	Operator-Control board-Belt-Aluminum guide 2mt+2mt
11084/2	UTILE 70 KG	Operator-Control board-Chain-Aluminum guide 2mt+2mt
11085/1	UTILE 100 KG	Operator-Control board-Belt-Iron guide 3mt
11084/1	UTILE 100 KG	Operator-Control board-Chain-Iron guide 3mt
11087/1	UTILE 100 KG	Operator-Control board-Belt-Aluminum guide 1,5mt+1,5mt
11086/1	UTILE 100 KG	Operator Control board-Chain-Aluminum guide 1,5mt+1,5mt
11084/3	UTILE 100 KG	Operator-Control board-Chain-Aluminum guide 2mt+2mt
11085/3	UTILE 100 KG	Operator-Control board-Belt-Aluminum guide 2mt+2mt



PZ. PALLET  
800x1200x1000 | 32 pz. 240 KG  
+ BEAM 800x300x50 120 KG

- For better radio reception we recommend the use of an external aerial code 210/1

## EXTRA ACCESSORIES

CODE	MODEL	DESCRIPTION
100084/2	ARCHETTO	Curved arm for counterweight doors
122004/1	SBLOCCO UTILE	Release with lock for sectional doors
1811/1	SBLOCCO UTILE	Release for existing handle for sectional doors
ST-450		Magnetic contact for overhead doors



**COD. 100084/2**  
Curved arm for counterweight doors



**COD. ST-450**  
Magnetic contact for overhead doors



**COD. 122004/1**  
Release with lock for sectional doors



**COD. 1811/1**  
Release for existing handle for sectional doors



**COD. E010**  
Remote control



**COD. 12/C**  
Pair of photocells



**COD. 23/8**  
LED flashing light



**COD. 23/4**  
Wall fixing base



**COD. 198/5**  
Key selector



**COD. 165B**  
Warning sign

Automations for Garage Doors

# BASIC 09

## ELECTROMECHANICAL OPERATOR 230V - 24V

**i** MAX SURFACE 10 MQ



INSTRUCTIONS



RESIDENTIAL



COLLECTIVE



POWER SUPPLY 230V - 24V



IRREVERSIBLE

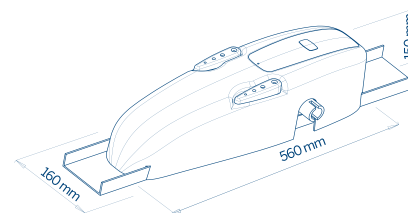

### FEATURES

- Irreversible electromechanical operator
- Steel and bronze gears obtained from solid
- Very quiet operation
- Lithium grease lubrications of mechanical parts against corrosion, oxidation and rust
- High Performance electric motor
- Operator 24V with Encoder
- Operator 230V with Encoder optional
- Start button placed on cover
- Release device with die-cast lever
- Available with or without control board
- Control board with built-in receiver and antenna
- Pre-wiring and easy programming software
- Electronic torque control
- Anti-squashing system \* (EN 12453)
- Slowing down function \* (EN 12453)
- Courtesy light
- Power supply 230V - 24V with Encoder
- Magnetic contact for pedestrian

\* Functions guaranteed with VDS electronics devices

### PERFORMANCE REQUIREMENTS

- Operating Cycle SEMI-INTENSIVE 230V, INTENSIVE 24V
- Use frequency 50% (230VAC) - 80% (24VCC)
- Opening time 15 SEC

### TECHNICAL FEATURES

	BASIC 09 230	BASIC 09 24
Power supply	230VAC	24V
Door weight	10 MQ	10 MQ
Engine RPM	1400 RPM	1800 RPM
Average absorption	1,3 A	3 A
Absorbed power	250 W	50 W
Condenser	12,5 UF	-
Motor weight	8,5 KG	8,5 KG
Noise level	< 30 DBA	< 30 DBA
Enviromental conditions	-20 / +55° C	-20 / +55° C
Protection degree	IP30	IP30
Max torque	200 NM	200 NM

NO SOLDERING  
REQUIRED

Available also with  
BROACHED SHAFT

## OPERATORS

CODE	MODEL	DESCRIPTION
759/09	BASIC 09 230V	Operator - Without control board
110411/09	BASIC 09 230V	Operator - Control board and built-in receiver 433 mHz
100034/09E	BASIC 09 24V	Operator - Control board and built-in receiver 433 mHz - Encoder
EN002	ENCODER	Extra for Basic Encoder 230V

 PZ. PALLET  
800x1200x1100 | 35 pz. 340 KG

- For better radio reception we recommend the use of an external aerial code 210/1

### EXTRA ACCESSORIES



**COD. CNT**  
Counterweight 1.5 kg  
overhead doors



**COD. 112530/2 - 112530/3**  
Straight arms kit



**COD. 112530/1 - 112530/4**  
Curved arms kit



**COD. 756**  
Support bar



**COD. ST-450**  
Magnetic contact for  
overhead doors



**COD. 122004/09**  
Release with Basic lock



**COD. 12/C**  
Pair of photocells



**COD. LD11**  
LED flasher



**COD. 23/8**  
LED flashing light



**COD. 23/4**  
Wall fixing base



**COD. 198/5**  
Key selector



**COD. E010**  
Remote control



**COD. 165B**  
Warning sign

CODE	MODEL	DESCRIPTION
CNT	CNT1	Counterweight 1.5 kg for overhead doors 20 mm
122004/09	SBL SERR	Release with Basic lock
756	LNG	Galvanized support bar 150 cm
756/4	LNG	Galvanized support bar 200 cm
112530/1	ACC. KIT 1MONOMOTORE	2 curved arms - 2 transmission shafts - 2 packs
112530/2	ACC. KIT 2MONOMOTORE	2 straight arms - 2 transmission shafts - 2 packs
112530/3	ACC. KIT 3BIMOTORE	2 straight arms - 2 packs
112530/4	ACC. KIT 4BIMOTORE	2 curved arms - 2 packs
LD11	LD	LED flasher
CL001	LD-CR	Multivoltage LED flashing circuit
ST-450		Magnetic contact for overhead doors

Automations for Garage Doors

# BASIC ON ELECTROMECHANICAL OPERATOR 230V

**i** MAX SURFACE 10 MQ



INSTRUCTIONS

- RESIDENTIAL
- COLLECTIVE
- POWER SUPPLY 230V
- IRREVERSIBLE

## FEATURES

- Irreversible electromechanical operator
- Suitable for 2 leaves counterweight doors
- Steel and bronze gears obtained from solid
- Very quiet operation
- Lithium grease lubrications of mechanical parts against corrosion, oxidation and rust
- High Performance electric motor
- Operator 230V with Encoder optional
- Release device with die-cast lever
- Available with or without control board
- Control board with built-in receiver and antenna
- Pre-wiring and easy programming software
- Electronic torque control
- Anti-squashing system \* (EN 12453)
- Slowing down function \* (EN 12453)
- Courtesy light
- Power supply 230V
- Magnetic contact for pedestrian

\* Functions guaranteed with VDS electronics devices

## PERFORMANCE REQUIREMENTS

- Operating Cycle SEMI-INTENSIVE 230V
- Use frequency 50% (230VAC)
- Opening time 15 SEC

## TECHNICAL FEATURES

Power supply	230VAC
Door weight	10 MQ
Engine RPM	1400 RPM
Average absorption	1,3 A
Absorbed power	250 W
Condenser	12,5 UF
Motor weight	8,5 KG
Noise level	< 30 DBA
Enviromental conditions	-20 / +55° C
Protection degree	IP30
Max torque	200 NM

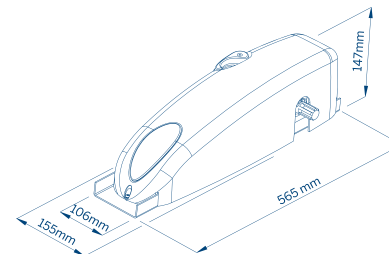

SAXO ARMS  
compatible

## OPERATORS

CODE	MODEL	DESCRIPTION
759	BASIC ON - 230V	Operator - Without control board
110411	BASIC ON - 230V	Operator - Control board and built-in receiver 433 mHz
EN002	ENCODER	Extra for Basic Encoder 230V



PZ. PALLET  
800x1200x1100 | 35 pz. 340 KG

• For better radio reception we recommend the use of an external aerial code 210/1

## EXTRA ACCESSORIES



**COD. CNT**  
Counterweight 1.5 kg  
overhead doors



**COD. 12/C**  
Pair of photocells



**COD. 112529/2 - 112529/3**  
Straight arms kit with  
broaching



**COD. LD11**  
LED flasher



**COD. 112529/1 - 112529/4**  
Curved arms kit with  
broaching



**COD. 23/8**  
LED flashing light



**112529/5**  
2 Saxo arms - Accessories



**COD. 23/4**  
Wall fixing base



**COD. 756**  
Support bar



**COD. 198/5**  
Key selector



**COD. ST-450**  
Magnetic contact for  
overhead doors



**COD. E010**  
Remote control



**COD. 122004/09**  
Release with Basic lock



**COD. 165B**  
Warning sign

CODE	MODEL	DESCRIPTION
CNT	CNT1	Counterweight 1.5 kg for overhead doors
122004/09	SBL SERR	Release with Basic lock
756/2	LNG	Galvanized support bar 57 cm
756	LNG	Galvanized support bar 150 cm
756/4	LNG	Galvanized support bar 200 cm
112529/1	ACC. KIT1 MONOMOTORE	2 curved arms - 2 transmission shafts - 2 packs
112529/2	ACC. KIT2 MONOMOTORE	2 straight arms - 2 transmission shafts - 2 packs
112529/3	ACC. KIT3 BIMOTORE	2 straight arms - Accessories
112529/4	ACC. KIT4 BIMOTORE	2 curved arms - Accessories
112529/ST	ACC. KIT BRACCI CURVI NO SALD.	Curved arms kit - not to be welded
112529/1ST	ACC. KIT BRACCI DRITTI NO SALD.	Straight arms kit - not to be welded
112529/5	ACC. KIT SAXO	2 Saxo arms - Accessories
LD11	LD	LED flasher
CL001	LD-CR	Multivoltage LED flashing circuit
ST-450		Magnetic contact for overhead doors

## INSTALLATION EXAMPLES SECTIONAL DOOR



QTY	CODE	DESCRIPTION
1	11086	Operator with control board - Aluminum guide 1,5+1,5 mt - With chain
1	122004/1	Release with lock
1	12/C	Pair of photocells Tech2
1	198/5	Key selector
1	E010	ECO-R remote control
1	165B	Warning sign



# INSTALLATION EXAMPLES **COUNTWEIGHT DOOR**



QTY	CODE	DESCRIPTION
1	110411/09	Operator with control board Basic 09
1	122004/09	Release with lock
1	112530/2	Straight arms kit
1	756	Support bar
1	12/C	Pair of photocells Tech2
1	198/5	Key selector
1	E010	ECO-R remote control
1	165B	Warning sign

The background features a solid blue field with a large, diagonal orange shape on the left side, creating a modern, abstract design.

# AUTOMATIONS FOR **ROAD BARRIERS**

Automations for Road Barriers

# ITALO

## ELECTROMECHANICAL BARRIER 230V

**i** ARMS UP TO 3 MT



INSTRUCTIONS

- RESIDENTIAL
- COLLECTIVE
- POWER SUPPLY 230V
- IRREVERSIBLE

### FEATURES

- Irreversible, intensive use
- Powder coated steel structure
- Motor box in cast aluminum
- Steel and bronze gears
- High Performance electric motor
- Air cooling by fan
- Mechanical parts lubricated with oil
- Opening and closing microswitches
- Spring balance
- Round arm standard - Rectangular arm optional
- Emergency release by knob
- Arm length max 3 mt / arm kit LED (optional)
- Pre-wiring and easy programming software
- Control board with built-in receiver and antenna
- Anti-squashing system \* (EN 12453)
- Mechanical slowdown of opening and closing
- Electronic torque control

\* Functions guaranteed with VDS electronics devices

### PERFORMANCE REQUIREMENTS

- Operating Cycle INTENSIVE
- Use frequency 100%
- Opening time 3 SEC

### TECHNICAL FEATURES

Power supply	230VAC
Max lenght arm	3 MT
Opening time	3 SEC
Absorbed power	250 W
Motor weight	45 KG
Noise level	< 30 DBA
Enviromental conditions	-20 / +55° C
Protection degree	IP44

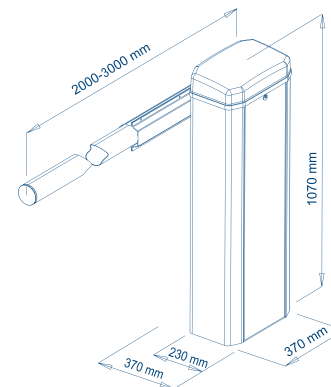

## BARRIER

CODE	MODEL	DESCRIPTION
1447	ITALO 230V	Barrier - Control board and built-in receiver 433 mHz



PZ. PALLET  
800x1200x1200 | 6 pz. 340 KG

• For better radio reception we recommend the use of an external aerial code 210/1

### EXTRA ACCESSORIES



**COD. 121854 /1**  
Round arm, Ø 80mm



**COD. 242**  
Fixed rod support

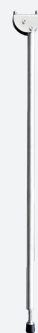

**COD. 141**  
Mobile amortized rod support



**COD. 121110**  
Fixing plate



**COD. 142**  
Mobile curtain



**COD. 150/8038**  
Shockproof mechanical protection

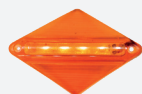

**COD. LD10**  
Round arm LED



**COD. 124512**  
Reflective stickers

CODE	MODEL	DESCRIPTION
121854	AT2	Round arm, Ø 80 mm - 2 mt
121854/1	AT3	Round arm, Ø 80 mm - 3 mt
121110	CPT	Fixing plate
242	SUPP	Fixed rod support
141	AST	Mobile amortized rod support
142	SIE	Mobile curtain - 2 mt
LD10	LED-T	1 LED for round arm
CL001	LD-CR	Multivoltage LED flashing circuit
124512	ACTR	Reflective stickers (pack of 6 pcs)
150/8038	PRT	Shockproof mechanical protection

Automations for Road Barriers

# BERTA

## ELECTROMECHANICAL BARRIER 230V -24V

**i ARMS UP TO 6 MT**



INSTRUCTIONS

-  RESIDENTIAL
-  COLLECTIVE
-  POWER SUPPLY 230V - 24V
-  IRREVERSIBLE

### FEATURES

- Irreversible, intensive use
- Powder coated steel structure
- Motor box in cast aluminum
- Steel and cast iron gears
- High Performance electric motor
- Mechanical parts lubricated with lithium grease
- Opening and closing microswitches
- Spring balance
- Round arm standard - Rectangular arm optional
- Emergency release by crank, 230V
- Mechanical release with key, 24V
- Arm length max 6 mt / arm kit LED (optional)
- Pre-wiring and easy programming software
- Control board with built-in receiver and antenna
- Anti-squashing system \* (EN 12453)
- Slowing down function \* (EN 12453)
- Electronic torque control
- Anti black out battery kit

\* Functions guaranteed with VDS electronics devices

### PERFORMANCE REQUIREMENTS

- Operating Cycle SEMI-INTENSIVE 230V, INTENSIVE 24V
- Use frequency 50% (230VAC) - 100% (24 CC)
- Opening time 10 SEC

### TECHNICAL FEATURES

	BERTA 230	BERTA 24
Power supply	230 VAC	24 VCC
Max lenght arm	6 MT	6 MT
Opening time	10 SEC	10 SEC
Absorbed power	250 W	60 W
Motor weight	45 KG	45 KG
Noise level	< 30 DBA	< 30 DBA
Enviromental conditions	-20 / +55° C	-20 / +55° C
Protection degree	IP44	IP44

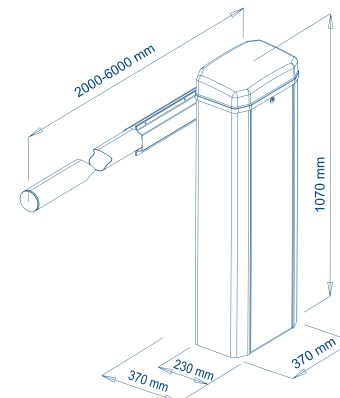

## BARRIERS

CODE	MODEL	DESCRIPTION
1445	BERTA 230V	Barrier - Control board - Arm from 3 to 6 mt
1445/2	BERTA 230V FAST	Barrier - Control board - Arm from 2 to 4 mt
1446	BERTA 24V	Barrier - Control board - Arm from 3 to 6 mt
1446/3	BERTA 24V FAST 3000	Barrier - Control board - Arm from 2 to 4 mt



PZ. PALLET  
800x1200x1200 | 6 pz. 340 KG

• For better radio reception we recommend the use of an external aerial code 210/1

### EXTRA ACCESSORIES



**COD. 121854 - /1/2/3/4**  
Round arm, Ø 80mm



**COD. 242**  
Fixed rod support



**COD. 141**  
Mobile amortized rod support



**COD. 121110**  
Fixing plate



**COD. 142**  
Mobile curtain

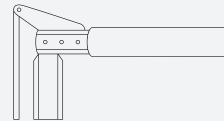

**COD. SN01**  
Articulated rod kit



**COD. 150/8038**  
Shockproof mechanical protection

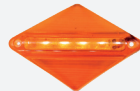

**COD. LD10**  
Round arm LED



**COD. 124512**  
Reflective stickers

CODE	MODEL	DESCRIPTION
121854	AT2	Round arm, Ø 80 mm - 2 mt
121854/1	AT3	Round arm, Ø 80 mm - 3 mt
121854/2	AT4	Round arm, Ø 80 mm - 4 mt
121854/3	AT5	Round arm, Ø 80 mm - 5 mt
121854/4	AT6	Round arm, Ø 80 mm - 6 mt
SN01	SND	Articulated rod kit
12478	GIU	Joint for round arm
121110	CPT	Fixing plate
242	SUPP	Fixed rod support
141	AST	Mobile amortized rod support
142	SIE	Mobile curtain - 2 mt
LD10	LED-T	1 LED for round arm
CL001	LD-CR	Multivoltage LED flashing circuit
124512	ACTR	Reflective stickers (pack of 6 pcs)
K009	BAT-B	24V Bev / Berta battery kit
150/8038	PRT	Shockproof mechanical protection

**KIT LED** recommended 1 per meter of the arm

**LED FLASHER CIRCUIT** steady light - sequential / rotating flashing

Automations for Road Barriers

# BEV 2

## ELECTROMECHANICAL BARRIER 230V - 24V

**i** ARMS UP TO 6 MT



INSTRUCTIONS



RESIDENTIAL



COLLECTIVE



POWER SUPPLY 230V - 24V



IRREVERSIBLE

### FEATURES

- Irreversible, intensive use
- Stainless steel structure
- Motor box in cast aluminum
- Steel and cast iron gears
- High Performance electric motor
- Mechanical parts lubricated with lithium grease
- Opening and closing microswitches
- Opening and closing microswitches
- Round arm standard - Rectangular arm optional
- Mechanical release with key
- Arm length max 6 mt / arm kit LED (optional)
- Pre-wiring and easy programming software
- Control board with built-in receiver and antenna
- Anti-squashing system \* (EN 12453)
- Slowing down function \* (EN 12453)
- Electronic torque control
- Anti black out battery kit

\* Functions guaranteed with VDS electronics devices

### PERFORMANCE REQUIREMENTS

- Operating Cycle SEMI-INTENSIVE 230V, INTENSIVE 24V
- Use frequency 50% (230VAC) - 100% (24VCC)
- Opening time 10 SEC

### TECHNICAL FEATURES

	BEV 2 230	BEV 2 24
Power supply	230VAC	24VCC
Max lenght arm	6 MT	6 MT
Opening time	10 SEC	10 SEC
Absorbed power	250 W	60 W
Motor weight	45 KG	45 KG
Noise level	< 30 DBA	< 30 DBA
Enviromental conditions	-20 / +55° C	-20 / +55° C
Protection degree	IP44	IP44

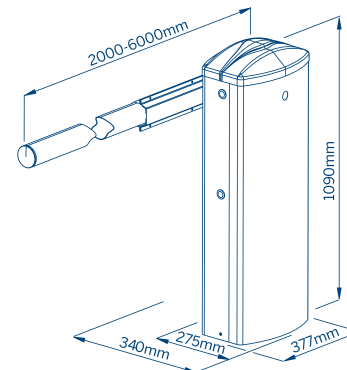

## BARRIERS

CODE	MODEL	DESCRIPTION
1432/V	BEV 2 230V	Barrier - Control board - Arm from 3 to 6 mt
1432/2V	BEV 2 230V FAST	Barrier - Control board - Arm from 2 to 4 mt
1428/V	BEV 2 24V	Barrier - Control board - Arm from 3 to 6 mt
1428/3V	BEV 2 24V FAST	Barrier - Control board - Arm from 2 to 4 mt



PZ. PALLET  
800x1200x1200 | 6 pz. 360 KG

• For better radio reception we recommend the use of an external aerial code 210/1

### EXTRA ACCESSORIES



**COD. 121854** - /1/2/3/4  
Round arm, Ø 80mm



**COD. 242**  
Fixed rod support

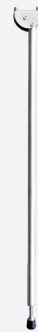

**COD. 141**  
Mobile amortized rod support



**COD. 121110**  
Fixing plate



**COD. 142**  
Mobile curtain

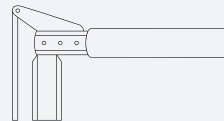

**COD. SN01**  
Articulated rod kit



**COD. 150/8038**  
Shockproof mechanical protection

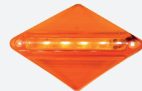

**COD. LD10**  
Round arm LED



**COD. 124512**  
Reflective stickers

CODE	MODEL	DESCRIPTION
121854	AT2	Round arm, Ø 80 mm - 2 mt
121854/1	AT3	Round arm, Ø 80 mm - 3 mt
121854/2	AT4	Round arm, Ø 80 mm - 4 mt
121854/3	AT5	Round arm, Ø 80 mm - 5 mt
121854/4	AT6	Round arm, Ø 80 mm - 6 mt
SN01	SND	Articulated rod kit
12478	GIU	Joint for round arm
121110	CPT	Fixing plate
242	SUPP	Fixed rod support
141	AST	Mobile amortized rod support
142	SIE	Mobile curtain - 2 mt
LD10	LED - T	1 LED for round arm
CL001	LD - CR	Multivoltage LED flashing circuit
124512	ACTR	Reflective stickers (pack of 6 pcs)
K009	BAT - B	24V Bev / Berta battery kit
150/8038	PRT	Shockproof mechanical protection

KIT LED recommended 1 per meter of the arm  
LED FLASHER CIRCUIT steady light - sequential / rotating flashing

Automations for Road Barriers

# BERTA MANUALE BARRIER

**i** ARMS UP TO 6 MT



INSTRUCTIONS



RESIDENTIAL



COLLECTIVE

## FEATURES

- Powder coated steel structure
- Motor box in cast aluminum
- Steel and cast iron gears
- Mechanical parts lubricated with lithium grease
- Round arm standard
- Crank release
- Arm length max 6 mt

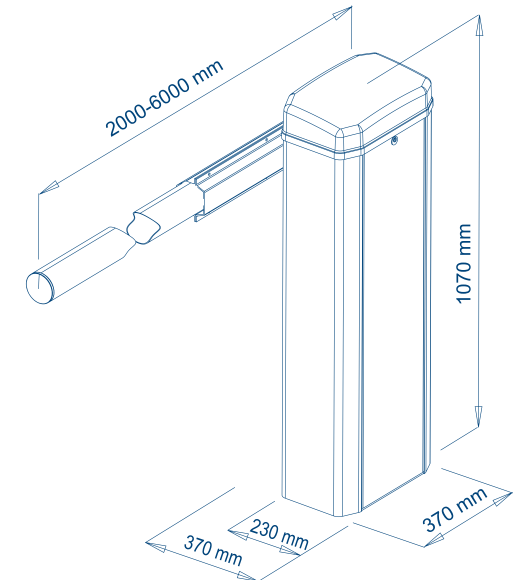

## BARRIERS

CODE	MODEL	DESCRIPTION
1440	BERTA - M	Manual barrier - Arm from 2 to 4 mt



PZ. PALLET  
800x1200x1200 | 6 pz. 340 KG

### EXTRA ACCESSORIES



**COD. 121854 - /1/2**  
Round arm, Ø 80mm



**COD. 242**  
Fixed rod support



**COD. 141**  
Mobile amortized rod support



**COD. 121110**  
Fixing plate



**COD. 142**  
Mobile curtain



**COD. 150/8038**  
Shockproof mechanical protection

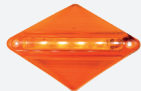

**COD. LD10**  
Round arm LED



**COD. 124512**  
Reflective stickers

CODE	MODEL	DESCRIPTION
121854	AT2	Round arm, Ø 80 mm - 2 mt
121854/1	AT3	Round arm, Ø 80 mm - 3 mt
121854/2	AT4	Round arm, Ø 80 mm - 4 mt
121854/3	AT5	Round arm, Ø 80 mm - 5 mt
121854/4	AT6	Round arm, Ø 80 mm - 6 mt
12478	GIU	Joint for round arm
121110	CPT	Fixing plate
242	SUPP	Fixed rod support
141	AST	Mobile amortized rod support
142	SIE	Mobile curtain - 2 mt
124512	ACTR	Reflective stickers (pack of 6 pcs)
150/8038	PRT	Shockproof mechanical protection

KIT LED recommended 1 per meter of the arm  
LED FLASHER CIRCUIT steady light - sequential / rotating flashing

A large, solid orange shape that starts from the top-left corner and extends diagonally towards the bottom-right, creating a sharp triangular cutout in the blue background.

# TRAFFIC **BOLLARDS**

Traffic Bollards

# MOLE

## VERTICAL HYDRAULIC BOLLARD 230V



INSTRUCTIONS



POWER SUPPLY 230V



IRREVERSIBLE



HYDRAULIC

### FEATURES

- Inner pillar in 4 mm thick steel
- Outer pillar (foundation case) in galvanized steel
- The automation does not need any adjustment and calibration, and this characterizes its immediate installation for proper operation
- The movement of the pillar ends automatically with the increase in the absorption of the electric motor
- The manual release takes place by acting on the upper part of the pylon with a triangular key
- The LED luminous flux visible at 360°, both with the mast lowered and raised, and the retro-reflective film guarantees perfect visibility of the bollard
- The fluidity of the pylon movement is ensured by an electromechanical system with epicyclic reduction in a watertight aluminum casing
- The control unit manages the movement ensuring maximum safety and constant performance over time

### PERFORMANCE REQUIREMENTS

- Operating Cycle **INTENSIVE**
- Use frequency **100%**
- Opening time **4,5 SEC**
- Closing time **2 SEC**

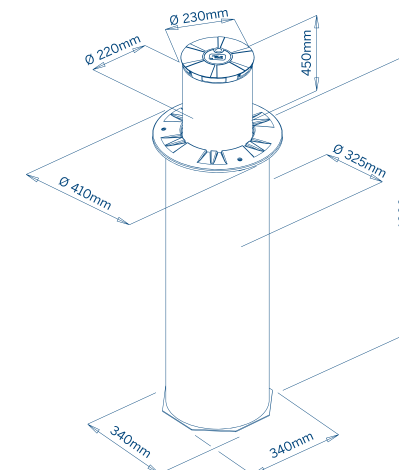

## BOLLARDS

CODE	MODEL	DESCRIPTION
2001/1	MOLE	Hydraulic bollard - Control board
2001/3	MOLE-F	Fixed bollard



PZ. PALLET  
800x120x130 | 3 pz. 400 KG

- For better radio reception we recommend the use of an external aerial code 210/1
- In presence of strong cold temperatures, the performance of the actuator can be significantly reduced

### EXTRA ACCESSORIES



**COD. E102/P**  
E102 control board with bollard software + receiver



**COD. 12/C**  
Pair of photocells



**COD. 23/8**  
LED flashing light



**COD. 23/4**  
Wall fixing base



**COD. E010**  
Remote control



**COD. 165B**  
Warning sign



Traffic Bollards

# ALZO CHAIN BARRIER

**i** PASSAGES UP TO 20 MT



INSTRUCTIONS



RESIDENTIAL



COLLECTIVE



POWER SUPPLY 230V - 24V



IRREVERSIBLE

## FEATURES

- Chain barrier to easily delimit small parkings or driveways
- Quick and easy installation
- Smart: thanks to obstacle detection and automatic stroke programming
- Always ready: operation in absence of current with rechargeable batteries that can be connected to the control board via the battery charger card, through a comfortable guided coupling connector
- Chain up to 20 mt in length
- Galvanized and painted steel structure
- It does not require maintenance and thanks to the magnetic loop you can improve the degree of automation of your application

## TECHNICAL FEATURES

Power supply	230VAC – 50HZ
Power supply	24 VDC
Average absorption	1.0
Absorbed power	24
Max chain length	20
Motor weight	16
Column height	1010
Service	50
Protection degree	34
Control unit	ACTION

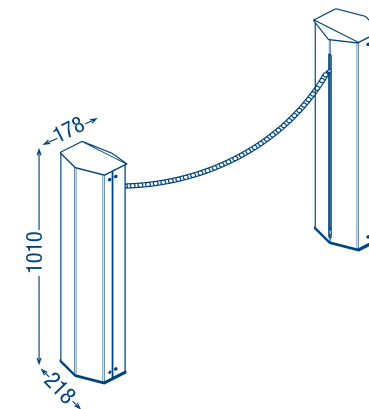

## OPERATORS

CODE	MODEL	DESCRIPTION
12007374	ALZ-M	Operator 24V with encoder - Built-in ACTION control board with slowdowns in opening and closing - Column height 1010 mm
12007379	ALZ-S	Operator 24V - Column height 1010 mm



PZ. PALLET  
800x1200x1200 | 6 pz. 340 KG

## EXTRA ACCESSORIES



**COD. 64000404**  
Two-tone white and red steel chain



**COD. 64000405**  
Steel and galvanized chain



**COD. 12007395**  
Breakout joint



**COD. 64000409**  
Recessed guide in galvanized sheet 2 mt



**COD. 61700406**  
M8x25 turned stainless steel screw



**COD. 64000407**  
Ø 6 mm stainless steel junction mesh



**COD. 12000780**  
24V plug-in battery charger with electronic charge control



**COD. 12000757**  
Batteries kit in box 2 batteries 1.3 Ah - 1 mt cable



**COD. 420**  
12V 7 Ah rechargeable battery - 2 batteries required



**COD. 12666482**  
433 mHz plug-in receiver - 1 channel - with antenna

The background features a solid blue field with a large, diagonal orange shape on the left side, creating a modern, abstract design.

# AUTOMATIONS FOR **ROLLING SHUTTERS**

Automations for Rolling Shutters

# TONDO

## OPERATOR FOR SHUTTERS

**WEIGHT UP TO 180 KG**



INSTRUCTIONS

 RESIDENTIAL

 COLLECTIVE

 POWER SUPPLY 230V

 IRREVERSIBLE

### FEATURES

- New design
- Quick installation even on existing shutters
- Irreversible
- Manual release
- Electric brake
- Mechanical limit switch built-in, easy adjustable
- Fast, reliable and silent
- Power supply 230V

### PERFORMANCE REQUIREMENTS

MODELS	A	B	C
TONDO 140	60/48 MM	200/220 MM	320 MM
TONDO 180	60/48 MM	200/220 MM	320 MM

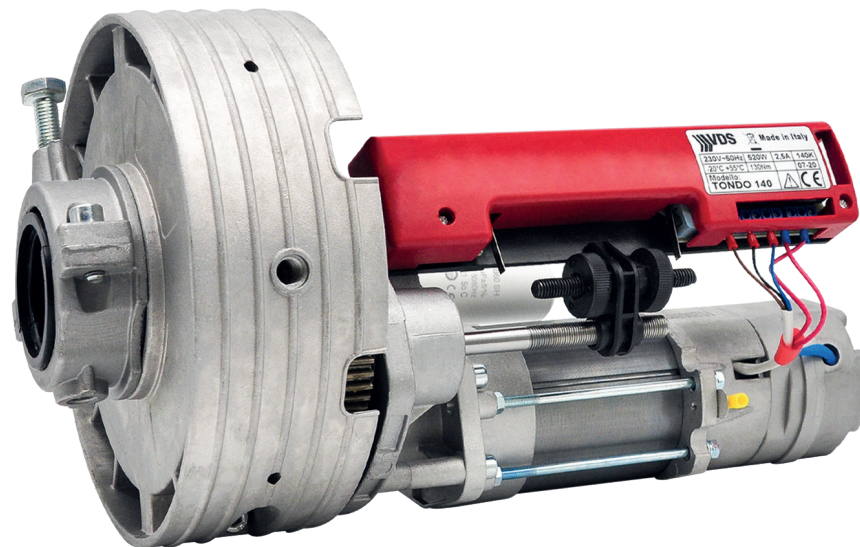

### TECHNICAL FEATURES

	TONDO 140	TONDO 180
Power supply	230VAC	230VAC
Lifting force	140 KG	180 KG
Condenser	18 UF	22 UF
Average absorption	2,5 A	2,5 A
Absorbed power	520 W	700 W
RPM ring	9 / MIN	9 / MIN
Motor weight	8 KG	10 KG
Enviromental conditions	-20 / +85° C	-20 / +85° C
Limit switch	6 MT	6 MT

## OPERATORS AND ACCESSORIES

CODE	MODEL	DESCRIPTION
1000043/R	TONDO 140	140 kg Shutter operator with electric brake - Ø 48-60
1000043/B	TONDO 180	180 kg Shutter operator with electric brake - Ø 48-60
RD33	AD 33	33 mm adapter - 1 pair
RD42	AD 42	42 mm adapter - 1 pair
RD48	AD 48	48 mm adapter - 1 pair
43364/050	ELT TONDO	Electric brake with release cable



PZ. PALLET  
800x1200x1300 | 50 pz. 520 KG

- For better radio reception we recommend the use of an external aerial code 210/1
- In presence of strong cold temperatures, the performance of the actuator can be significantly reduced

## EXTRA ACCESSORIES



**COD. S-0215-01**  
Control board with built-in receiver and antenna



**COD. 12/C**  
Pair of photocells



**COD. 23/8**  
LED flashing light



**COD. 23/4**  
Wall fixing base



**COD. 198/5**  
Key selector



**COD. E010**  
Remote control



**COD. 165B**  
Warning sign



**COD. 854/1**  
Blindino selector

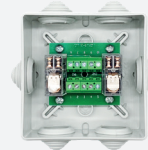

**COD. 93370000**  
Control board for the control of 2 dead-man motors - without receiver



**COD. 93330000**  
Control board for the control of 4 dead-man motors - without receiver



**COD. 96050000**  
Control board with low voltage dead-man controls - without receiver

Automations for Rolling Shutters

# ROLL OPERATOR FOR SHUTTERS

**i** WEIGHT UP TO 300 KG



INSTRUCTIONS



RESIDENTIAL

COLLECTIVE

POWER SUPPLY 230V

REVERSIBLE

IRREVERSIBLE

## FEATURES

- New design
- Quick installation even on existing shutters
- Irreversible
- Manual release
- Electric brake
- Mechanical limit switch built-in, easy adjustable
- Fast, reliable and silent
- Power supply 230V

## PERFORMANCE REQUIREMENTS

MODELS	A	B	C
ROLL 200 150 KG	60/48 MM	200/220 MM	320 MM
ROLL 200/2M 300 KG	60/48 MM	200/220 MM	320 MM
ROLL 240 170 KG	76/101 MM	240 MM	320 MM
ROLL 240/2M 300 KG	76/101 MM	240 MM	320 MM

## TECHNICAL FEATURES

	ROLL 200	ROLL 240	ROLL 200-2 M	ROLL 240-2 M
Power supply	230VAC	230VAC	230VAC	230VAC
Lifting force	150 KG	170 KG	300 KG	300 KG
Condenser	16 UF	20 UF	35 UF	40 UF
Average absorption	2 A	2,8 A	2X2,8 A	2X2,8 A
Absorbed power	400 W	600 W	2X600 W	2X600 W
RPM ring	9 / MIN	8 / MIN	8 / MIN	8 / MIN
Motor weight	8 KG	9 KG	11 KG	13 KG
Environmental conditions	-20 / +85° C	-20 / +85° C	-20 / +85° C	-20 / +85° C
Limit switch	7 / 8 MT	7 / 8 MT	7 / 8 MT	7 / 8 MT

## OPERATORS AND ACCESSORIES

CODE	MODEL	DESCRIPTION
1000043	ROLL 200	150 kg Shutter operator - Ø 48-60 - Without electric brake
100099/5	ROLL 240	170 kg Shutter operator with electric brake Ø76-101mm
100099/6	ROLL 240 - 2M	300 kg Double shutter operator with electric brake Ø76-101mm
100099/7	ROLL 200 - 2M	300 kg Double shutter operator with electric brake - Ø48-60mm
RD33	AD 33	adapter - 1 pair
RD42	AD 42	42 mm adapter - 1 pair
RD48	AD 48	48 mm adapter - 1 pair
1000043/1	ELT	Electric brake with release cable



PZ. PALLET  
800x1200x1300 | 50 pz. 520 KG

- For better radio reception we recommend the use of an external aerial code 210/1
- In presence of strong cold temperatures, the performance of the actuator can be significantly reduced

## EXTRA ACCESSORIES



**COD. S-0215-01**  
Control board with built-in receiver and aerial



**COD. 12/C**  
Pair of photocells



**COD. 23/8**  
LED flashing light



**COD. 23/4**  
Wall fixing base



**COD. 198/5**  
Key selector



**COD. E010**  
Remote control



**COD. 165B**  
Warning sign



**COD. 854/1**  
Blindino selector

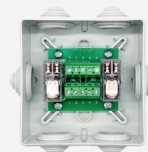

**COD. 93370000**  
Control board for the control of 2 dead-man motors - without receiver

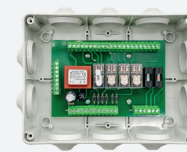

**COD. 93330000**  
Control board for the control of 4 dead-man motors - without receiver

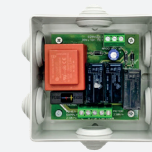

**COD. 96050000**  
Control board with low voltage dead-man controls - without receiver



**COD. 1000043/1**  
Electric brake with release

The background consists of a solid blue field with a large, diagonal orange shape on the left side, creating a modern, geometric aesthetic.

## AUTOMATIONS FOR **SHUTTERS AND AWINGS**

Automations for Shutters and Awings

# KINDI

## AUTOMATION FOR SHUTTERS

**i** WEIGHT UP TO 139 KG



CODE	MODEL	DESCRIPTION
12365	KINDI 20 NM	Tubular motor - Shutters up to 36 kg - Bracket and adapter 60 mm
12458	KINDI 30 NM	Tubular motor - Shutters up to 56 kg - Bracket and adapter 60 mm
125648	KINDI 50 NM	Tubular motor - Shutters up to 90 kg - Bracket and adapter 60 mm
125655	KINDI 100 NM	Tubular motor - Shutters up to 139 kg - Minimum bracket and adapter



RESIDENTIAL

POWER SUPPLY 230V

### INSTRUCTIONS

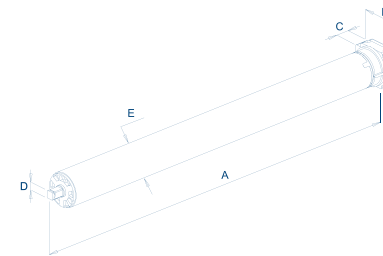

### PERFORMANCE REQUIREMENTS

- Operator in cast aluminum painted
- New design
- Mechanical limit switch
- Speed, silence and reliability
- Bracket and adapter 60/70 mm
- Wide range of adapters and accessories
- Extra 5 year warranty
- Power supply 230V
- Motor weight 3 kg

### TECHNICAL FEATURES

	A	B	C	D	E
KINDI 20	456 MM	55 MM	17 MM	10X10 MM □	45 MM Ø
KINDI 30	536 MM	55 MM	17 MM	10X10 MM □	45 MM Ø
KINDI 50	536 MM	55 MM	17 MM	10X10 MM □	45 MM Ø
KINDI 100	660 MM	70 MM	21 MM	30 MM Ø ○	60 MM Ø



PZ. PALLET  
800x1200x1200 | 80 pz. 320 KG

Automations for Shutters and Awings

# KENDA

## AUTOMATION WITH EMERGENCY MANEUVER

**i** WEIGHT UP TO 139 KG



 RESIDENTIAL

 POWER SUPPLY 230V

### INSTRUCTIONS

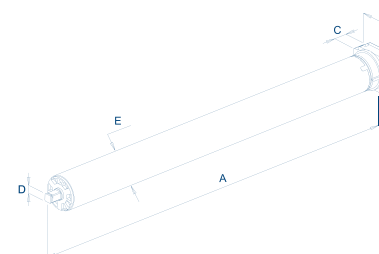

### PERFORMANCE REQUIREMENTS

- Operator in cast aluminum painted
- New design
- Mechanical limit switch
- Speed, silence and reliability
- Bracket and adapter 60/70 mm
- Wide range of adapters and accessories
- Extra 5 year warranty
- Power supply 230V
- Motor weight 3 kg

### TECHNICAL FEATURES

	A	B	C	D	E
KENDA 50	660 MM	70 MM	21 MM	30 MM	□ 45 MM Ø
KENDA 100	700 MM	100 MM	28 MM	10X10 MM Ø	○ 60 MM Ø

CODE	MODEL	DESCRIPTION
43000/90	KENDA 50 NM	Tubular motor - With maneuver - Curtains up to 90 kg
125656	KENDA 100 NM	Tubular motor - With maneuver - Curtains up to 139 kg - Minimum adapter 70 mm

 PZ. PALLET  
800x1200x1200 | 80 pz. 320 KG

# ACCESSORIES FOR SHUTTERS



CODE	DESCRIPTION
AM5196	Control board - 230V - With radio receiverkhvvhg

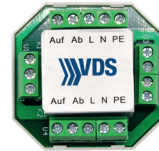

CODE	DESCRIPTION
1610111-MA1	Roller shutter module for single commands - Without receiver



CODE	DESCRIPTION
PROXMINI	Control board - 230V - With radio receiver

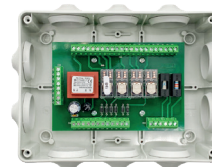

CODE	DESCRIPTION
93330000	Control unit for the control of 2 motors to man present - Without receiver



CODE	DESCRIPTION
AM5154	Remote control - 6 channels - With display
AM5189	Remote control - 12 channels - With display



CODE	DESCRIPTION
93370000	Control unit for the control of 2 motors to man present - Without receiver

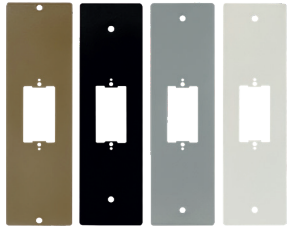

CODE	DESCRIPTION
PLA142B	Plate with hole for button - Center distance 142 Bronze
PLA142G	Plate with hole for button - Center distance 142 Grey
PLA142W	Plate with hole for button - Center distance 142 White
PLA142N	Plate with hole for button - Center distance 142 Black
PLA165B	Plate with hole for button - Center distance 165 Bronze
PLA165G	Plate with hole for button - Center distance 165 Grey
PLA165W	Plate with hole for button - Center distance 165 White
PLA165N	Plate with hole for button - Center distance 165 Black
PLA185B	Plate with hole for button - Center distance 185 Bronze
PLA185G	Plate with hole for button - Center distance 185 Grey
PLA185W	Plate with hole for button - Center distance 185 White
PLA185N	Plate with hole for button - Center distance 185 Black
PLA205B	Plate with hole for button - Center distance 205 Bronze
PLA205G	Plate with hole for button - Center distance 205 Grey
PLA205W	Plate with hole for button - Center distance 205 White
PLA205N	Plate with hole for button - Center distance 205 Black

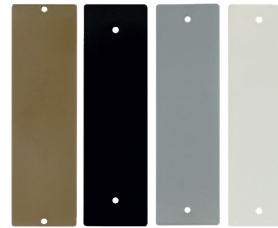

CODE	DESCRIPTION
PLA142B/C	Blind plate with center distance 142 Bronze
PLA142G/C	Blind plate with center distance 142 Grey
PLA142W/C	Blind plate with center distance 142 White
PLA142N/C	Blind plate with center distance 142 Black
PLA165B/C	Blind plate with center distance 165 Bronze
PLA165G/C	Blind plate with center distance 165 Grey
PLAT165W/C	Blind plate with center distance 165 White
PLA165N/C	Blind plate with center distance 165 Black
PLA185B/C	Blind plate with center distance 185 Bronze
PLA185G/C	Blind plate with center distance 185 Grey
PLAT185W/C	Blind plate with center distance 185 White
PLA185N/C	Blind plate with center distance 185 Black
PLA205B/C	Blind plate with center distance 205 Bronze
PLA205G/C	Blind plate with center distance 205 Grey
PLAT205W/C	Blind plate with center distance 205 White
PLA205N/C	Blind plate with center distance 205 Black



CODE	DESCRIPTION
INT001	Up-down button with support

Automations for Shutters and Awings | **Accessories for Shutters**

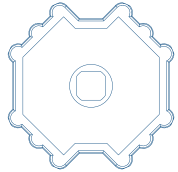

CODE	DESCRIPTION
43380/156	Octagonal for roller Ø 60 mm

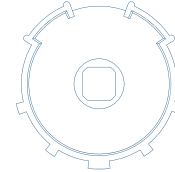

CODE	DESCRIPTION
43380/060	ZF 54

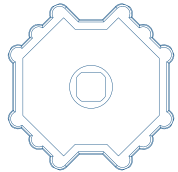

CODE	DESCRIPTION
43380/061	Octagonal for roller Ø 70 mm

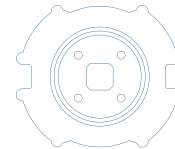

CODE	DESCRIPTION
43380/062	ZF 64

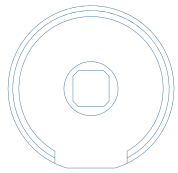

CODE	DESCRIPTION
43380/063	Round for roller Ø 50 mm

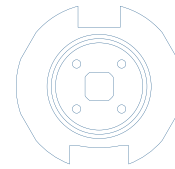

CODE	DESCRIPTION
43380/065	DEPRAT 62

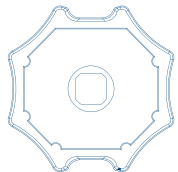

CODE	DESCRIPTION
43380/058	Bonfanti - Gaviota

Automations for Shutters and Awings | **Accessories for Shutters**



CODE	DESCRIPTION
43380/110	Adjustable support



CODE	DESCRIPTION
140MKA	Articulated maneuver rod with hook



CODE	DESCRIPTION
43380/111	Wall support



CODE	DESCRIPTION
43380/057	Adjustable support

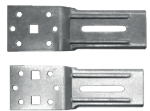

CODE	DESCRIPTION
43380/102	Bracket for box one-position
43380/101	Bracket for box two-position



CODE	DESCRIPTION
43380/068	Support with release



CODE	DESCRIPTION
43380/116	Hexagonal eyelet kit 7mm



CODE	DESCRIPTION
43380/109	Flat support square pin

Automations for Shutters and Awings | **Accessories for Shutters**

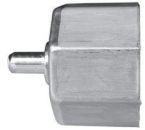

CODE	MODEL	DESCRIPTION
<b>G41CF</b>	CAL	Galvanized cap Ø 60 mm



CODE	MODEL	DESCRIPTION
<b>GU68CU</b>	SU-CU	Support with bearing

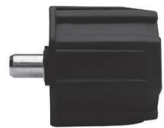

CODE	MODEL	DESCRIPTION
<b>G43CP</b>	CAL-PV7	PVC cap Ø 70 mm
<b>777/4</b>	CAL-PV6	PVC cap Ø 60 mm

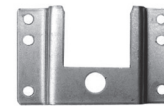

CODE	MODEL	DESCRIPTION
<b>777/11</b>	STAF-P	Wall bracket



CODE	MODEL	DESCRIPTION
<b>AI70-1</b>	CAL-R7	Adjustable cap Ø 70 mm
<b>AI60-3</b>	CAL-R6	Adjustable cap Ø 60 mm



CODE	MODEL	DESCRIPTION
<b>777/12</b>	CU-ST	Bearing for wall bracket



CODE	MODEL	DESCRIPTION
<b>GA3R608/1</b>	RU1	Octagonal roller Ø 60 - 1000 mm
<b>GA3R608/1.5</b>	RU15	Octagonal roller Ø 60 - 1500 mm
<b>GA3R608/2</b>	RU2	Octagonal roller Ø 60 - 2000 mm
<b>GA3R70/2</b>	RU2-7	Octagonal roller Ø 70 - 2000 mm
<b>GA370/3</b>	RU3-7	Octagonal roller Ø 70 - 3000 mm



CODE	MODEL	DESCRIPTION
<b>1098/DS</b>	TES	Motor head

Automations for Shutters and Awings | **Accessories for Shutters**



CODE	MODEL	DESCRIPTION
G62CU	ST-CUS	Bracket with bearing



CODE	MODEL	DESCRIPTION
GA8S70	BLC-T	Shutter lock Ø 70 mm



CODE	MODEL	DESCRIPTION
777/20	ZNC	Wall support



CODE	MODEL	DESCRIPTION
GA8S60/4	BLC-T	Shutter lock Ø 60 mm

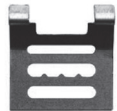

CODE	MODEL	DESCRIPTION
777/15	GAZ	Galvanized hook



CODE	MODEL	DESCRIPTION
777/18	DLC-T	Shutter lock



CODE	MODEL	DESCRIPTION
VS178/F	178	Anti-scratch attachment spring

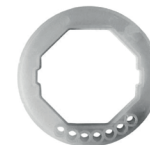

CODE	MODEL	DESCRIPTION
777/19	ANL	Ring Ø 60 mm for shutter block

# ACCESSORIES FOR AWINGS

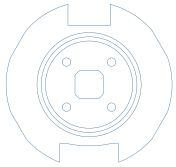

CODE	DESCRIPTION
TECH/ V5005/C	Warhead for tube Ø 60 mm

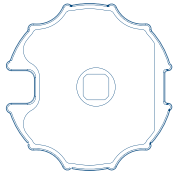

CODE	DESCRIPTION
43380/064	Warhead for tube Ø 70 mm

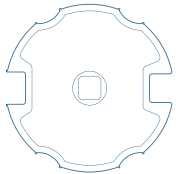

CODE	DESCRIPTION
43380/059	Warhead for tube Ø 78 mm



CODE	DESCRIPTION
71600	Warhead for tube Ø 70 mm - Thickness 10/10 <span style="float: right;">mt</span>



CODE	DESCRIPTION
81600	Warhead for tube Ø 78 mm - Thickness 10/10 <span style="float: right;">mt</span>



CODE	DESCRIPTION
14035	Adjustable ogive cap Ø 70 mm
15035	Adjustable ogive cap Ø 78 mm



CODE	DESCRIPTION
14001	Ogive cap Ø 70 mm
18001	Ogive cap Ø 78 mm

Automations for Shutters and Awings | **Accessories for Awings**



CODE	DESCRIPTION
74	Wind speed detector



CODE	DESCRIPTION
76	Control board - 230V - With radio receiver - With box

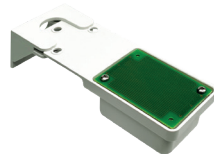

CODE	DESCRIPTION
RA	Ambient light detector



CODE	DESCRIPTION
AM5154	Remote control - 6 channels - With display
AM5189	Remote control - 12 channels - With display



CODE	DESCRIPTION
RS	Rain detector

Automations for Shutters and Awings | **Accessories for Awings**



CODE	DESCRIPTION
93370000	Control unit for the control of 2 motors to man present - Without receiver

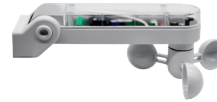

CODE	DESCRIPTION
96800000	Control unit for the control of 4 motors to man present - Without receiver



CODE	DESCRIPTION
93070000	Individual or centralized control board for 4 motors with inputs for wind, sun, rain sensors - Without receiver



CODE	DESCRIPTION
96860000	Electronic control board with anemometer and sun sensor - With radio receiver



CODE	DESCRIPTION
93330000	Apparecchiatura di comando per il controllo di 4 motori a uomo presente - Senza ricevente



CODE	DESCRIPTION
91710005	1 channel remote control
91720005	3 channels remote control
91730005	6 channels remote control

ACCESSORIES FOR  
**SKYLIGHTS, WINDOWS, DOMES**

Accessories for Skylights, Windows, Domes

# MICRO EVO 1

## CHAIN OPERATOR



INSTRUCTIONS



RESIDENTIAL



POWER SUPPLY 230V

### FEATURES

- Linear electric operator with double link articulated chain contained within a metal casing
- Equipped with overload protection system and automatic limit switch adjustment in closing
- It has 4 types of electronically selectable strokes
- Equipped with a synchronization system capable of coordinating the movement of the chain of several operators (up to 4) without the need for any external control board
- Complete with accessories for installation on hinged windows or
- vasistas
- Possibility of adjusting the stroke by means of a selector
- Soft stop closure to preserve the window
- Reduced height: 35 mm

### TECHNICAL FEATURES

Power	MAX THRUST 300N
Voltage	110-240V / 24V
Power	110-240V AC: 25W / 24V DC: 24W
Stroke selectable	100 - 200 - 300 - 400
Limit switch opening and closing	ELECTRONIC
Protection degree	IP32
Minimum speed	CA. 13 MM/S
Operating temperature	-10° C + 40° C
Certifications	CE - VDE



### OPERATORS

CODE	DESCRIPTION	COLOR	THRUST	POWER	PROTECTION DEGREE	MINIMUM SPEED
2713789	MICRO EVO1 - 230V	Silver	300 N	25 W	IP32	13 mm/s
2713790	MICRO EVO1 - 230V	Black RAL 9005	300 N	25 W	IP32	13 mm/s
2713791	MICRO EVO1 - 230V	White RAL 9003	300 N	25 W	IP32	13 mm/s
2713792	MICRO EVO1 - 24V	Silver	300 N	24 W	IP32	13 mm/s
2713793	MICRO EVO1 - 24V	Black RAL 9005	300 N	24 W	IP32	13 mm/s
2713794	MICRO EVO1 - 24V	White RAL 9003	300 N	24 W	IP32	13 mm/s



PZ. PALLET  
800x1200x1200 | 80 pz. 320 KG

Accessories for Skylights, Windows, Domes

# D8 FCE ROD OPERATOR



INSTRUCTIONS



RESIDENTIAL



POWER SUPPLY 230V

## FEATURES

- Rigid rod linear electric operator with high resistance to peak loads
- Operation with 230V AC 50Hz power supply
- Compliant with the relevant European Directives
- Equipped with limit switches and relays for parallel connection
- Built-in thermal protection
- Available color: silver anodized
- Complete with fixing accessories

## TECHNICAL FEATURES

Power	MAX THRUST 300N-TRACTION: MAX 300N
Voltage	230V AC 50HZ
Limit switch opening and closing	MICROSWITCH
Protection degree	IP55
Operating temperature	-10° C + 60° C
Cable	PVC BLACK
Certifications	CE - VDE



## OPERATORS

CODE	MODEL	DESCRIPTION
2700292	D8-200	D8 Fce - 200 mm - 500 N - 175 W - IP55 - Silver
2700293	D8-300	D8 Fce - 300 mm - 500 N - 175 W - IP55 - Silver
2700297	D8-400	D8 Fce - 400 mm - 500 N - 175 W - IP55 - Silver

## ACCESSORIES

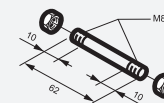

**COD. 2700102**  
Front pin for sunshade versions

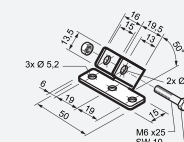

**COD. 2700064**  
Front bracket for window frame

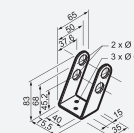

**COD. 2700124**  
Silver actuator support bracket

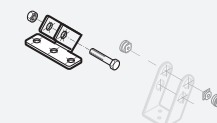

**COD. 2700107**  
Front frame bracket + actuator bracket accessories



PZ. PALLET  
200 pz. 6000 KG

The background features a solid blue color with a large, diagonal orange shape on the left side. The text is centered in the blue area.

AUTOMATIONS FOR  
**SLIDING DOORS AND TURNSTILES**

# RIKI-20

## AUTOMATIC TURNSTILE



INSTRUCTIONS



RESIDENTIAL



COLLECTIVE



POWER SUPPLY 230V

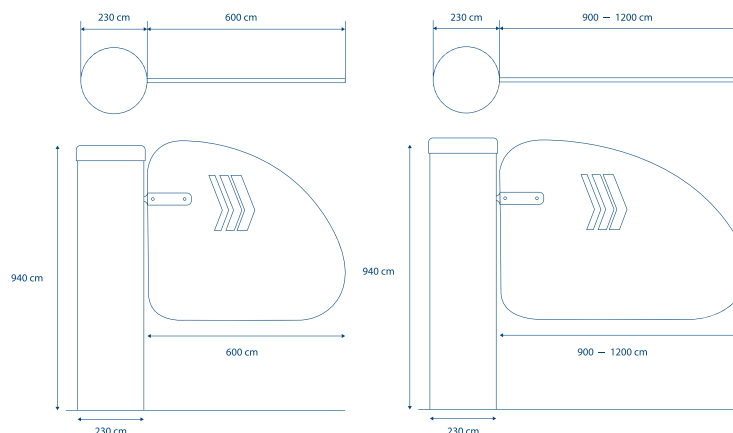

### FEATURES

- AISI 304 stainless steel structure and polycarbonate leaf
- Integrated luminous crown: indicates suitability for entry and movement of the wing (red: stop - green: okay)
- Integration with access control: people counter system, temperature measurement system, detects mask. The opening of the leaf can also be activated by a card reader, by photocells or other control device
- The system can be interfaced with other automatic opening systems
- The leaf can be closed automatically or activated by device command (also via radio)
- The release maneuver can be carried out using a button or a key
- Polycarbonate leaf is available in 3 sizes 600-900-1200 mm
- The system can work with buffer batteries allowing operation even in the event of a blackout black-out. The system is equipped with an amperometric safety device controlled by an encoder: if you accidentally hit the leaf, it stops, goes back and then performs a slow maneuver to check for the absence of obstacles

### TECHNICAL FEATURES

Protection degree	IP44
Power supply	120 / 230VAC
Motor power supply	24 DC
Absorption (standby)	350 MA
Power	120 W
Operating temp. (° C)	-20 / +55
Motor weight	25 KG
Opening time	2 - 3 SEC

Available with  
HI-SECURITY  
DEVICE

## TURNSTILES

CODE	MODEL	DESCRIPTION
RK020	RIK120-60	Turnstile with 60 mm polycarbonate door - LED light ring
RK020/1	RIK120-90	Turnstile with 90 mm polycarbonate door - LED light ring
RK020/2	RIK120-120	Turnstile with 120 mm polycarbonate door - LED light ring

 PZ. PALLET  
4 pz. 250 KG

### EXTRA ACCESSORIES



**COD. RS020**  
Hi-Security thermal monitor



**COD. RT020**  
Table bracket



**COD. RT021**  
Floor bracket

CODE	MODEL	DESCRIPTION
RS020	MONI-R	Hi-Security thermal monitor
RT020	STAF-R	Table bracket for Hi-Security
RT021	STAF-PR	Floor bracket for Hi-Security

### APPLICATIONS

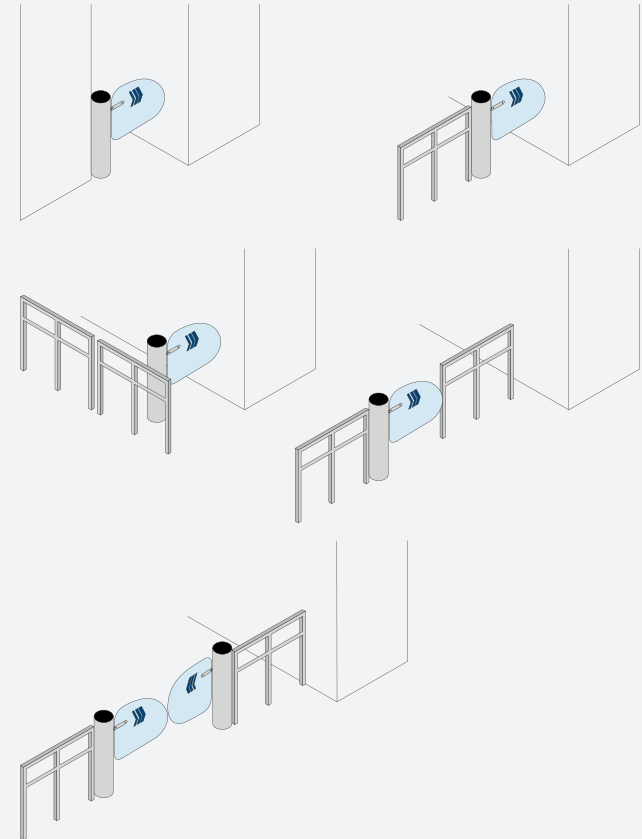

Automations for Sliding Doors and Turnstiles

## **SPEED PLUS**

### SLIDING DOOR AUTOMATION

#### **FEATURES**

---

- Reversible 1 motor automation for sliding doors
- Suitable for offices, supermarkets and high traffic shops
- Quick and silent movement
- Quick and easy installation
- Motor group with 100 pulses optical encoder
- Remote programming via digital selector
- Safety tests
- Interlock function
- Air curtain management

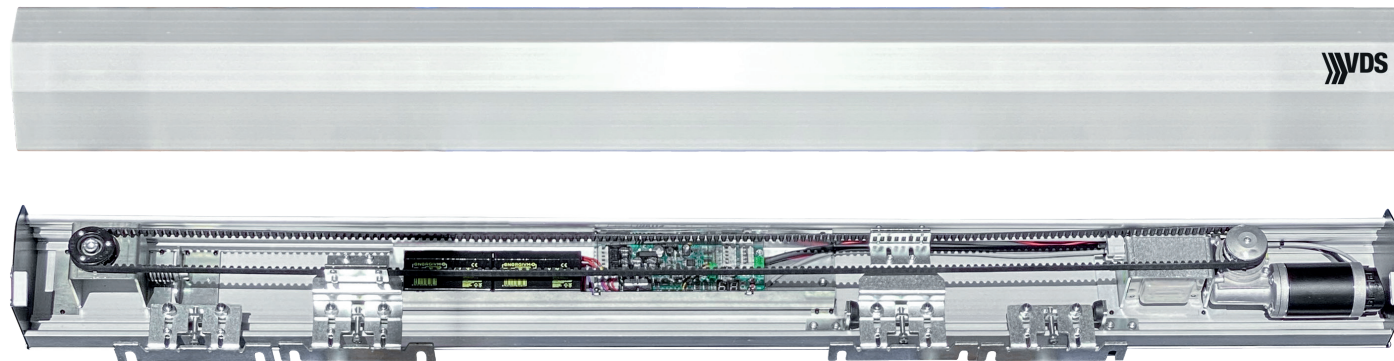

IN COMPLIANCE  
WITH **EN16005**

## COVERALL 1 LEAF WITH MAXIMUM WEIGHT OF 120 KG

CODE	COVERALL LENGHT ( MM)	NET PASSAGE WIDTH (MM)	LEAF LENGHT (MM)
501/1370	1370	600	700
501/1570	1570	700	800
501/1770	1770	800	900
501/1970	1970	900	1000
501/2370	2370	1100	1200
501/2770	2770	1300	1400
501/3170	3170	1500	1600
501/3570	3570	1700	1800
501/3970	3970	1900	2000
501/4370	4370	2100	2200
501/4770	4770	2300	2400
501/5170	5170	2500	2600
501/5570	5570	2700	2800
501/5970	5970	2900	3000



INSTRUCTIONS

## COVERALL 2 LEAVES WITH MAXIMUM WEIGHT OF 80 + 80 KG

CODE	COVERALL LENGHT ( MM)	NET PASSAGE WIDTH (MM)	LEAF LENGHT (MM)
502/1720	1720	800	2 x 450
501/1920	1920	900	2 x 500
502/2320	2320	1100	2 x 600
502/2720	2720	1300	2 x 700
502/3120	3120	1500	2 x 800
502/3520	3520	1700	2 x 900
502/3920	3920	1900	2 x 1000
502/4320	4320	2100	2 x 1100
502/4720	4720	2300	2 x 1200
502/5120	5120	2500	2 x 1300
502/5520	5520	2700	2 x 1400
502/5920	5920	2900	2 x 1500

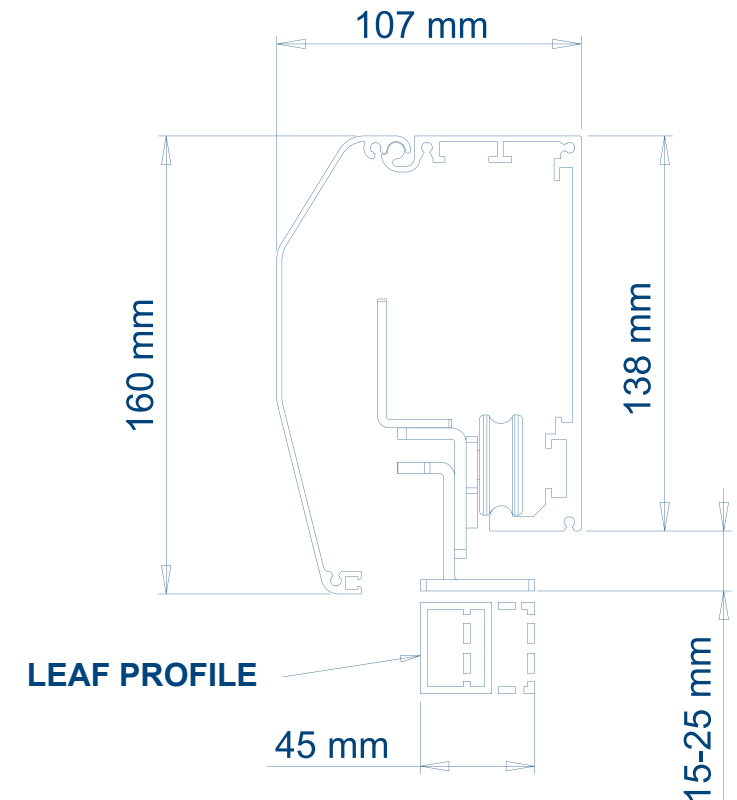

Automations for Sliding Doors and Turnstiles

## GEMINI ADVANCE

### SLIDING DOOR AUTOMATION

#### FEATURES

---

- Reversible 1 motor automation for sliding doors
- Suitable for offices, supermarkets and high traffic shops
- Quick and silent movement
- Quick and easy installation
- Motor group with 100 pulses optical encoder
- Remote programming via digital selector
- Safety tests
- Interlock function
- Air curtain management

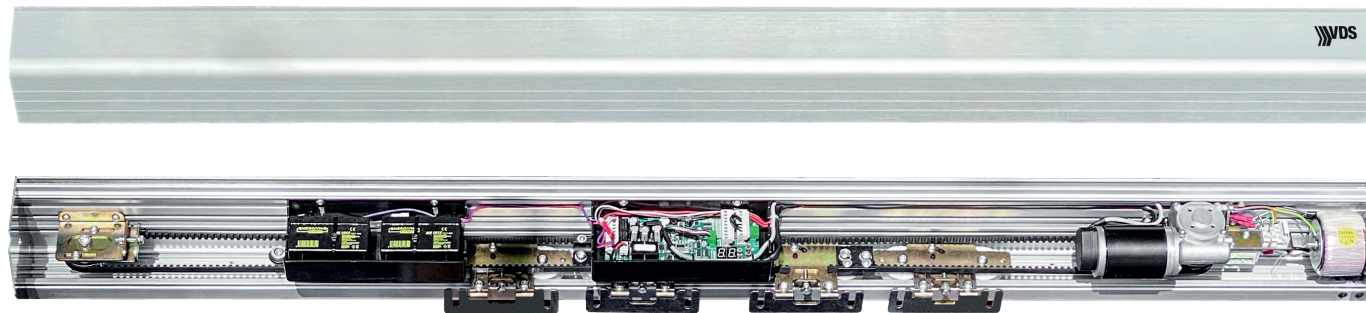

IN COMPLIANCE  
WITH EN16005

## COVERALL 1 LEAF WITH MAXIMUM WEIGHT OF 150 KG

CODE	COVERALL LENGHT ( MM)	NET PASSAGE WIDTH (MM)	LEAF LENGHT (MM)
607/1370	1370	600	700
607/1570	1570	700	800
607/1770	1770	800	900
607/1970	1970	900	1000
607/2370	2370	1100	1200
607/2770	2770	1300	1400
607/3170	3170	1500	1600
607/3570	3570	1700	1800
607/3970	3970	1900	2000
607/4370	4370	2100	2200
607/4770	4770	2300	2400
607/5170	5170	2500	2600
607/5570	5570	2700	2800
607/5970	5970	2900	3000



INSTRUCTIONS

## COVERALL 2 LEAVES WITH MAXIMUM WEIGHT OF 100 + 100 KG

CODE	COVERALL LENGHT ( MM)	NET PASSAGE WIDTH (MM)	LEAF LENGHT (MM)
608/1720	1720	800	2 x 450
608/1920	1920	900	2 x 500
608/2320	2320	1100	2 x 600
608/2720	2720	1300	2 x 700
608/3120	3120	1500	2 x 800
608/3520	3520	1700	2 x 900
608/3920	3920	1900	2 x 1000
608/4320	4320	2100	2 x 1100
608/4720	4720	2300	2 x 1200
608/5120	5120	2500	2 x 1300
608/5520	5520	2700	2 x 1400
608/5920	5920	2900	2 x 1500

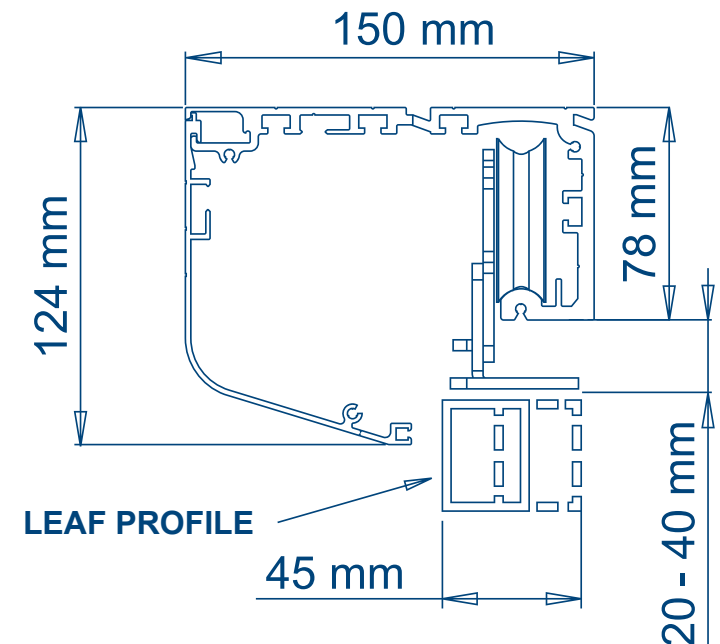

# ACCESSORIES



CODE	MODEL	DESCRIPTION
64/F	JET01	Multifunction selector with display



CODE	MODEL	DESCRIPTION
604/D	SEL	Multifunction digital touch selector



CODE	MODEL	DESCRIPTION
12/TS	TOUCH	Touch switch

**IDEAL FOR HOSPITALS**



CODE	MODEL	DESCRIPTION
100074/ECO	HR50-ECO	Omnidirectional microwave sensor

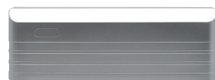

CODE	MODEL	DESCRIPTION
100074/16	ACTIR	Active infrared sensor



CODE	MODEL	DESCRIPTION
100074/21	HR50	Omnidirectional microwave sensor



CODE	MODEL	DESCRIPTION
100074/22	HR100	Infrared sensor for activation and detection safety - Compliant with the EN16005 standard



CODE	MODEL	DESCRIPTION
IXIO-DT3	IXIO	Microwave sensor for activation and active infrared for safety - Compliant with standard EN16005 - DN18650



CODE	MODEL	DESCRIPTION
KEY-98	KEY-09	Wireless touch keyboard - Backlit - IP64 - 2 channels with receiver

Automations for Sliding Doors and Turnstiles | **Accessories**



CODE	MODEL	DESCRIPTION
RS020	MONI-R	Hi-Security thermal monitor



CODE	MODEL	DESCRIPTION
100074/11	GUI	Floor guide for glass door



CODE	MODEL	DESCRIPTION
FOTO9S1A	FOTO9S1A	Amplifier for 1 pair of photocells



CODE	MODEL	DESCRIPTION
0049	GUI-1	Floor guide



CODE	MODEL	DESCRIPTION
FOTO9S2A	FOTO9S2A	Amplifier for 2 pairs of photocells



CODE	MODEL	DESCRIPTION
614	ELT B	Speed complete electric lock
614/1	ELT G	Gemini complete electric lock



CODE	MODEL	DESCRIPTION
CR10MS	CR10MS	Pair of photocells to be combined with the amplifier



CODE	MODEL	DESCRIPTION
611	AB1	1 door partial abatement system
612	AB2	2 doors partial abatement system
613	ANT-S	Battery anti-panic system for Speed
613/1	ANT-G	Battery anti-panic system for Gemini



CODE	MODEL	DESCRIPTION
608	SEP	Crystal door support profile ( per meter)



CODE	MODEL	DESCRIPTION
122002	CHN	Spare strap at mt for Speed and Gemini

Automations for Sliding Doors and Turnstiles

## DOOR FRAMES PROFILES



CODE	MODEL	DESCRIPTION
PF007	PROF-A	Horizontal door frame profile - 1 mt
PF006	PROF-B	Vertical door frame profile - 1 mt
0049	GUI-1	Floor guide
0051	SPAZZ	Brush - 1 mt

Automations for Sliding Doors and Turnstiles | **Door Frames Profiles**

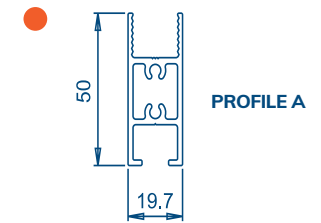
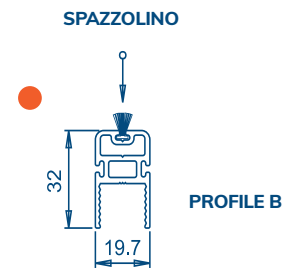
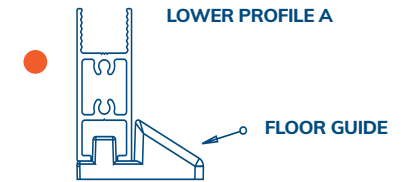
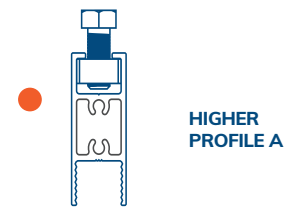
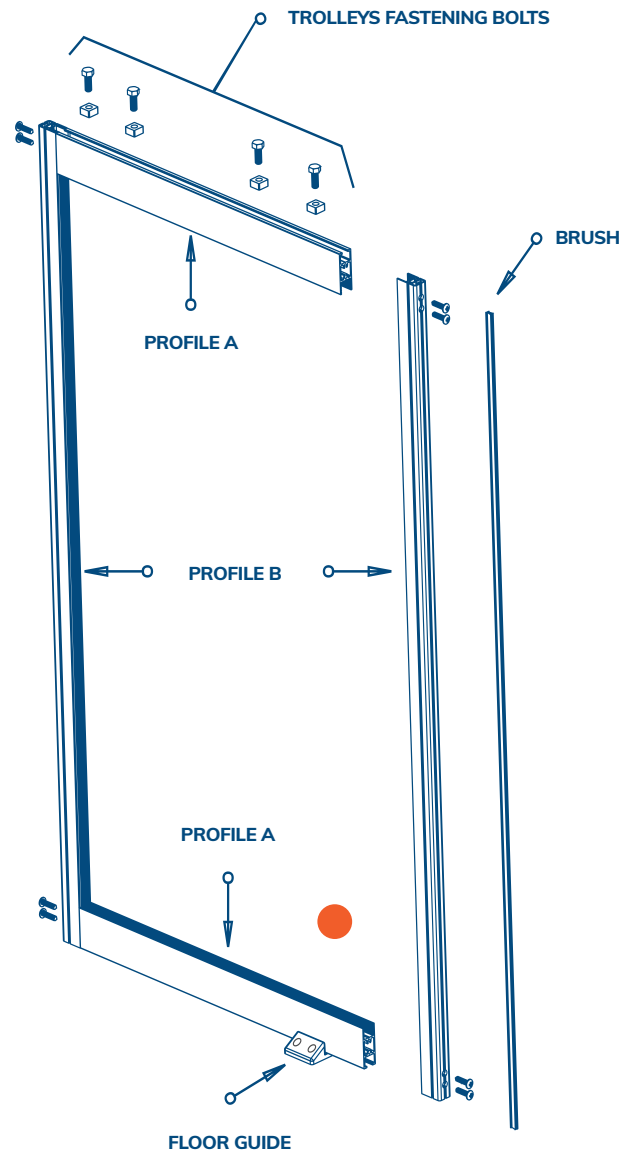

# COMPLETE DOORS

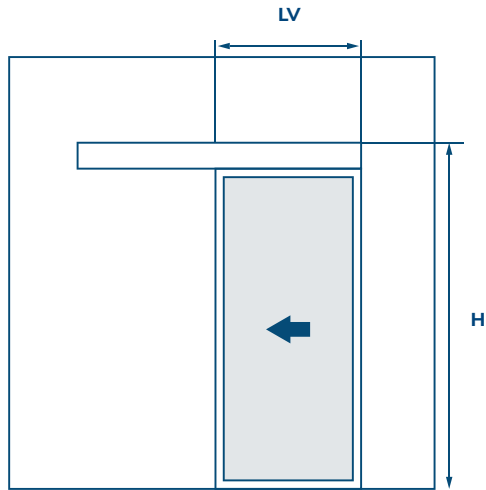

## ENTRANCE WITH 1 SLIDING DOOR (RIGHT OR LEFT OPENING)

DESCRIPTION	LVM mm	HVM 3450 mm	HVM 4000 mm
Complete entrance door frame made with automation profiles supplied pre-assembled and with gaskets for glass	1000	upon request	upon request
	1200	upon request	upon request
	1600	upon request	upon request
	2000	upon request	upon request

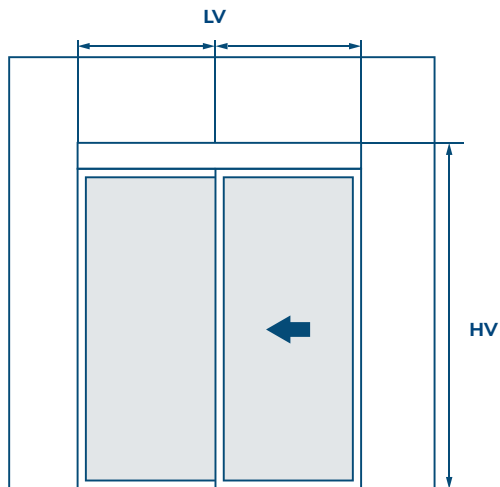

## ENTRANCE WITH 1 SLIDING DOOR + 1 FIXED SIDE DOOR (RIGHT OR LEFT OPENING)

DESCRIPTION	LVM mm	HVM 3450 mm	HVM 4000 mm
Complete entrance door frame made with automation profiles supplied pre-assembled and with gaskets for glass	1200	upon request	upon request
	1600	upon request	upon request
	2000	upon request	upon request
	3000	upon request	upon request

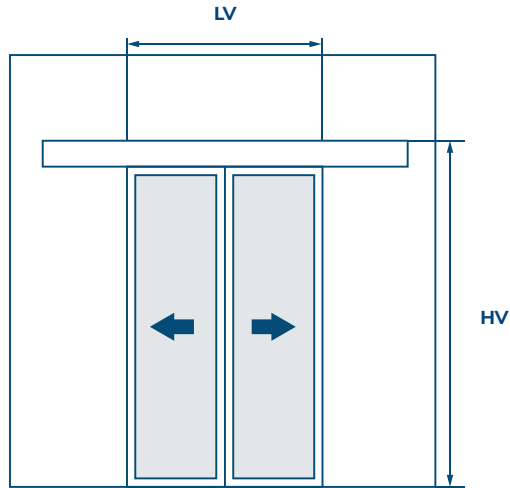

### ENTRANCE WITH 2 SLIDING DOORS

DESCRIPTION	LVM mm	HVM 3450 mm	HVM 4000 mm
Complete entrance door frame made with automation profiles supplied pre-assembled and with gaskets for glass	1200	upon request	upon request
	1600	upon request	upon request
	2000	upon request	upon request
	2600	upon request	upon request
	3000	upon request	upon request

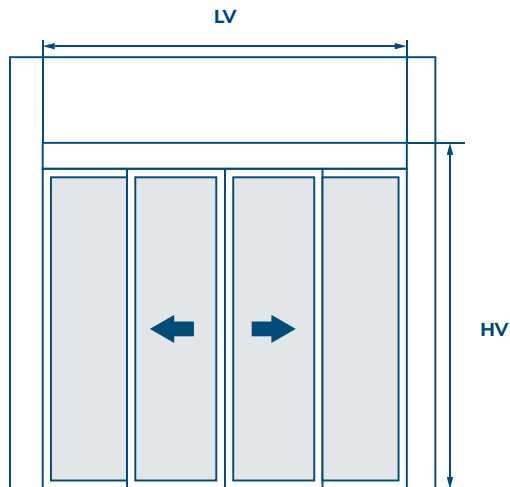

### ENTRANCE WITH 2 SLIDING DOORS + 2 FIXED SIDE DOORS

DESCRIPTION	LVM mm	HVM 3450 mm	HVM 4000 mm
Complete entrance door frame made with automation profiles supplied pre-assembled and with gaskets for glass	2000	upon request	upon request
	3000	upon request	upon request
	4000	upon request	upon request
	5000	upon request	upon request

The page features a dark blue background with a large, bright orange geometric shape on the left side, consisting of a triangle and a trapezoid. The text is centered in the blue area.

# ELECTRONIC **CONTROL BOARD**

# CONTROL BOARD



CODE	MODEL
<b>E105</b>	EURO 230 M2

- Control board 230VAC
- In box
- For Swing Gates 1 or 2 leaf
- Self-learning radio receiver
- Rolling-code and fix code to be selected by switch
- Electric limit switch
- Slowing down function / pedestrian input



CODE	MODEL
<b>F101</b>	ELB 230 M2

- Control board 230VAC
- In box
- For Swing Gates 1 or 2 leaf
- Self-learning radio receiver
- Rolling-code and fix code
- Electric limit switch
- Slowing down function / pedestrian input



CODE	MODEL
<b>E112</b>	EURO 230 M2 MINI

- Control board 230VAC
- In box
- For Swing Gates 1 or 2 leaf
- Self-learning radio receiver
- Rolling-code
- Slowing down function / pedestrian input

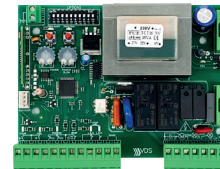

CODE	MODEL
<b>E102</b>	EURO 230 M1

- Control board 230VAC
- Sliding Gates, Barriers, Counterweight doors
- Self-learning radio receiver
- Rolling-code and fix code to be selected by switch
- Electric limit switch
- Slowing down function / pedestrian input



CODE	MODEL
<b>F103</b>	ELB 24 M2

- Control board 24VAC
- In box
- For Swing Gates 1 or 2 leaf
- Self-learning radio receiver
- Rolling-code and fix code to be selected by switch
- Electric limit switch
- Slowing down function / pedestrian input

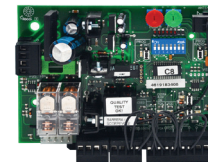

CODE	MODEL
<b>E103</b>	EURO 24 M1

- Control board 24VCC
- Sliding Gates, Barriers, Counterweight doors
- Self-learning radio receiver
- Rolling-code and fix code to be selected by switch
- Electric limit switch
- Slowing down function / pedestrian input

Electronic Control Board | **Control Board**



CODE	MODEL
<b>E107</b>	EURO 380 M1

- Control board 230/380VAC
- In box
- Sliding Gates
- Rolling-code and fix code to be selected by switch



CODE	MODEL
<b>S-0215-01</b>	MINI

- Control board 230VAC
- In box
- Rolling Shutters
- Self-learning radio receiver
- Rolling-code and fix code
- Flashing, courtesy light
- Dead man function
- LED light included in the box

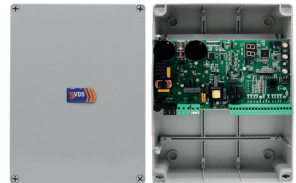

CODE	MODEL
<b>Q100</b>	INVERTER

- Control board 230/380VAC
- In box
- Sliding Gates
- Trimmer speed and strenght setting
- Amperometric sensitivity management
- Dead man function



CODE	MODEL
<b>G030</b>	AT070

- Control board 24VCC
- Selectional and Counterweight doors
- Self-learning radio receiver
- Rolling-code
- LED for courtesy light



CODE	MODEL
<b>CSER1R</b>	ROLLY

- Control board 230VAC
- In box
- Rolling Shutters
- Self-learning radio receiver
- Rolling-code and fix code
- Flashing, courtesy light
- Dead man function

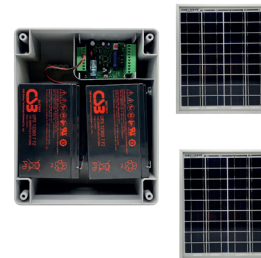

COD
<b>SUNPOWER</b>

- Power kit with 2 solar panels applicable to all 24VDC automations

Electronic Control Board | **Control Board**



CODE	DESCRIPTION
93370000	Control board for controlling 2 dead-man motors - Without radio receiver



CODE	DESCRIPTION
480	Transformer 100 VA - 230 / 24VAC - Toroidal - For Bev2 / Berta / Carrera
TR006	Transformer 150 VA - 230/20 VAC - Toroidal - For Gemini



CODE	DESCRIPTION
93330000	Control board for controlling 4 dead-man motors - Without radio receiver

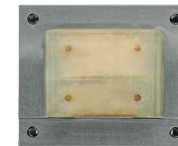

CODE	DESCRIPTION
478/1	Transformer 100 VA - 230/24VAC - Lamellar for Utile 70 / Simply
478/P	Transformer 140 VA - 230/24VAC - Lamellar for Utile 100 / Riki20
TR003	Transformer 150 VA - 230/20 VAC - Lamellar for Speed Plus - F103



CODE	DESCRIPTION
ALA1	3VA terminal block power supply with 230VAC input and 24VAC output - For photocells and flashing lights

# RADIO SYSTEMS



CODE	MODEL	DESCRIPTION
TX01	MULTI2	2 channels remote control- 433,92 mHz - Copyable - Rolling code - Fixing code



CODE	MODEL	DESCRIPTION
E010	ECO-R	5 channels remote control- 433,92 mHz - Rolling code



CODE	MODEL	DESCRIPTION
TX02	MULTI4	4 channels remote control - 433,92 mHz - Copyable - Rolling code - Fixing code



CODE	MODEL	DESCRIPTION
164/1	FRQ	Frequency counter



CODE	MODEL	DESCRIPTION
TX-E	ECO-E	4 channels remote control- 433,92 mHz - Rolling code

Electronic Control Board | **Radio Systems**

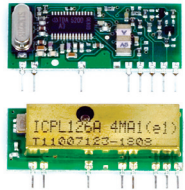

CODE	MODEL	DESCRIPTION
1000/1	EHT	Plug-in hybrid 433 mHz - Super heterodyne - Universal
1000	SCH	Plug-in hybrid 433 mHz - Shielded - Universal



CODE	MODEL	DESCRIPTION
E002	SMR24C2	External radio receiver in box 433mHz - 2 channels - 12/24VCC - Rolling code with aerial
E003	SMR220C2	External radio receiver in box 433 mHz - 2 channels - 230VAC - Rolling code with aerial



CODE	MODEL	DESCRIPTION
E001	SMR220C4	External radio receiver in box 433 mHz - 4 channels - 230VCC - Rolling code with aerial



CODE	MODEL	DESCRIPTION
E062	SRT_MINI	Plug-in receiver 433 mHz - 1 channel - Rolling code



CODE	MODEL	DESCRIPTION
E142	SRM	External radio receiver in box 433 mHz - 1 channel - 12/24VCC - Small size - With aerial



CODE	MODEL	DESCRIPTION
210/1	ANT	Aerial with 4,50 mt cable and bracket - 433 mHz

**RADIO - RANGE 1 KM - BIDIRECTIONAL**

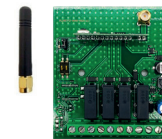

CODE	MODEL	DESCRIPTION
519/0020	MARCONI	4-channel receiver with aerial



CODE	MODEL	DESCRIPTION
519/0022	MARCONI	4-channel remote control

The page features a dark blue background with a large, bright orange geometric shape on the left side, consisting of a triangle and a trapezoid. The text is centered in the blue area.

# AUTOMATION **ACCESSORIES**

# ACCESS CONTROL



CODE	DESCRIPTION
ANT1	Hands free system for vehicles and people entry or exit 1 entrance
ANT2	Hands free system for vehicles and people entry and exit 2 entrances
1000925	Active tag



CODE	DESCRIPTION
MTPADPBK-EH-SA	Stand alone keypad with proximity reader - 1 relay - 12/24V - IP655



CODE	DESCRIPTION
B100SA	Stand alone biometric reader for outdoor use 97 fingerprints IP65 - Silver



CODE	DESCRIPTION
INOX-SA	Metallic keyboard Slim line gray / chrome stand alone - 1 relay - 12/24V - IP65



CODE	DESCRIPTION
B100BK-SA-KIT	Stand alone biometric reader kit for external 97 fingerprints IP65 + RTT - Black edition



CODE	DESCRIPTION
VKP99	Stand alone keypad with proximity reader - 1 relay - 12/24V - IP65



CODE	DESCRIPTION
MTPADS-SA	Stand alone metal keypad 1000 codes - 1 relay 12/24V - IP65 - Silver



CODE	DESCRIPTION
MINI-SA2	Stand alone proximity reader - 1 relay - 12/24V - IP65

Automation Accessories | **Access Control**



CODE	MODEL	DESCRIPTION
EASYNEW-DIGIKEE	KEYPAD	Vandal-proof cable keypad - IP67 protection degree - 30 codes - 12V AC DC power supply



CODE	DESCRIPTION
CA001	125 khz card



CODE	MODEL	DESCRIPTION
KEY-98	KEY-9	Wireless touch keypad - Backlit - IP64 - 2 channels with receiver



CODE	DESCRIPTION
BA001	125 khz keychain



CODE	MODEL	DESCRIPTION
SPROX	TAG1	Autonomous proximity reader
SKEY	TAG2	Key for TAG reader 1
E001	SMR23C4	External receiver for TA



CODE	DESCRIPTION
FA001	125 khz bracelet

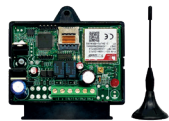

CODE	MODEL	DESCRIPTION
1434/2	GSM-C	Gate opening GSM module - 2 channels - With aerial



CODE	DESCRIPTION
XPR-FLEX30	Flexible steel cable glands - L 300x12 mm - Stainless steel
XPR-FLEX50	Flexible steel cable glands - L 500x12 mm - Stainless steel



CODE	DESCRIPTION
MC-MINI	Single stainless steel cover for readers

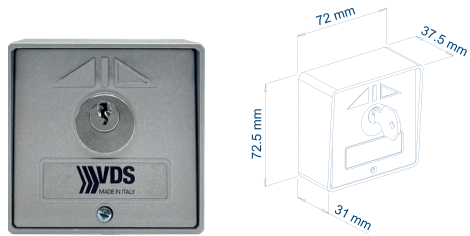

CODE	MODEL	DESCRIPTION
198/2	PLA	Outdoor selector - Start / stop - Aluminum
178/CA	PLA2	Pair of selectors with same coding

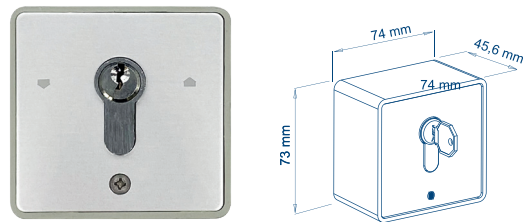

CODE	MODEL	DESCRIPTION
198/ECO	PLA-E	Outdoor selector - Start / Stop - Aluminum - European cylinder

## SELECTOR TECHNICAL FEATURES

Protection degree	IP54
Operating temperature	-20 / +85° C
Switch absorption	16 A

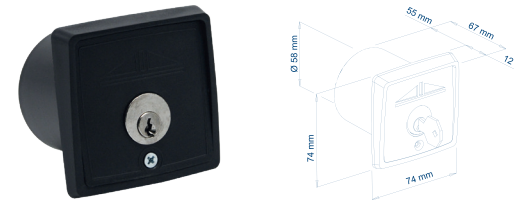

CODE	MODEL	DESCRIPTION
200	INK	Wall selector - ABS plastic
STP013	INK-R	Round adapter, for old series
200/C	INK-C	Pair of selectors with same coding



CODE	MODEL	DESCRIPTION
198/5	PLA-ABS	Outdoor selector - Start / stop - Technopolymer
198/CP	PLA-ABS2	Pair of selectors with same coding

## Automation Accessories | Access Control

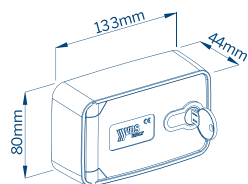

CODE	MODEL	DESCRIPTION
854	MAYA	Blindino wall selector with electro-brake - Push-button - Aluminum - European cylinder
854/1	MAYA1	Blindino wall selector with electro-brake - Aluminum - European
854/CP	MAYA1C	Pair of selectors with release and same coding
854/C	MAYA-C	Pair of selectors with release and same coding

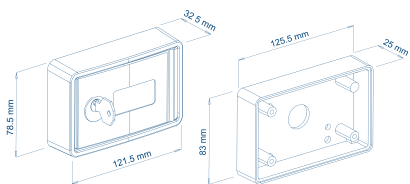
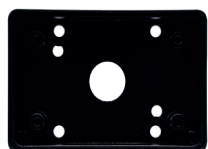

CODE	MODEL	DESCRIPTION
754/1	BLINDOR	Blindino wall selector with electro-brake - Push-button - Aluminum
754/6	BLINDOR1	Blindino wall selector with electro-brake - Aluminum
754/CS	BLINDOR-CS	Pair of selectors with release and same coding
754/CP	BLINDOR-CP	Pair of selectors with same coding - With button
754/2	BLB	Wall fixing base



CODE	MODEL	DESCRIPTION
QDM1	230V	Loop detector - 230V - 1 channel - With box
SMR-24	24V	Loop detector - 12/24V - 1 channel - With box



CODE	MODEL	DESCRIPTION
262598	PROLOOP	Loop detector - 230V - 1 channel - Din bar
550/1224	MAGNETIX	Loop detector - 12/24V - 1 channel - Din bar

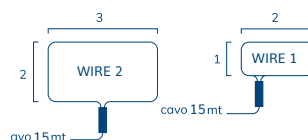

CODE	MODEL	DESCRIPTION
263	WIRE 1	Pre-assembled loop to be buried 3x2 mt + 6 mt cable
264	WIRE 2	Pre-assembled loop to be buried e 5x2 mt + 10 mt cable

# SAFETY AND DETECTION



CODE	MODEL	DESCRIPTION
12/T	FS	Pair of wall photocells - Slim -Range 40 mt - Power supply 12/24V



CODE	MODEL	DESCRIPTION
FT25B	FT BAT	Pair of photocells with batteries - Range 10 mt - 12/24V
BATF	BATTERY	Spare battery kit



CODE	MODEL	DESCRIPTION
12/C	TECH2	Pair of wall photocells - Range 15 mt - NO NC contact - Power supply 12/24V



CODE	MODEL	DESCRIPTION
RP25	FTCS	Mirror photocell - Range 12 mt - Power supply 12/24V
589/8150	FTCS	Square catadioptric 100x100 mm - Range 15 mt
589/8122		Black case for protection against rain, bumps and reflections for photocell
589/0200		Black case to protect rain, shocks and reflections for round reflector
589/8121		Anti-condensation accessory for reflector diameter 82 mm



CODE	MODEL	DESCRIPTION
12/FVG180	FVG180	Pair of 180° adjustable wall photocells - Range 12 mt - Power supply 12/24V



CODE	MODEL	DESCRIPTION
12/FOTO-LAMP	FL	Pair of wal adjustable photocells with flashing light - Range 12 mt - Power supply 12/24V



CODE	MODEL	DESCRIPTION
18	FTINC	Pair of embedded photocells - Range 12 mt - Power supply 12/24V
250	CN-IN	Metal container for wall application



CODE	MODEL	DESCRIPTION
12/FB	FB	Pair of armored wall photocells - 180° adjustable - Range 15 mt - Power supply 12/24V

Automation Accessories | **Safety and Detection**



CODE	DESCRIPTION
NASTRO-R	Reflective adhesive tape - Red - 1 mt

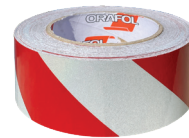

CODE	DESCRIPTION
NASTRO-RB	Reflective adhesive tape - Red and White - 1 mt

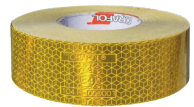

CODE	DESCRIPTION
NASTRO-G	Reflective adhesive tape - Yellow - 1 mt



CODE	DESCRIPTION
ACA085801ZB	Anti-fall galvanized ring



CODE	DESCRIPTION
NASTRO-B	Reflective adhesive tape - White - 1 mt



CODE	MODEL	DESCRIPTION
AC02-200	700	Stainless steel fall arrest cable - 700 mm



CODE	DESCRIPTION
NASTRO-GN	Reflective adhesive tape - Black and Yellow - 1 mt



CODE	MODEL	DESCRIPTION
AC02-100	515	Stainless steel fall arrest cable - 515 mm

Automation Accessories | **Safety and Detection**



CODE	MODEL	DESCRIPTION
790/0028	FALCON	Microwave detector for industrial doors



CODE	DESCRIPTION
E050	Wireless safety band - Transmitter



CODE	MODEL	DESCRIPTION
551/0620	RM620	Simplified microwave detector for industrial doors



CODE	DESCRIPTION
E051	Wireless safety band - Receiver



CODE	MODEL	DESCRIPTION
790/2010	FLATSCAN SW	Laser sensor for swing doors - Single LEFT
790/2011	FLATSCAN SW	Laser sensor for swing doors - Single RIGHT
790/2022	FLATSCAN DX-SX	Double laser sensor for swing doors - RIGHT LEFT



CODE	DESCRIPTION
TXR-P8	Wireless safety band - Transmitter with 2 batteries supplied



CODE	MODEL	DESCRIPTION
HYU-444	444	ANPR camera for license plate reading applicable on all VDS automations



CODE	DESCRIPTION
RXR-P8	Radio safety band - Receiver



CODE	MODEL	DESCRIPTION
230/5	BS01	1,5mt sensitive edge-H 70mm-Black
230/3	BS01	1,7mt sensitive edge-H 70mm-Black
230/1	BS01	2mt sensitive edge-H 70mm-Black
230/4	BS01	2,5mt sensitive edge-H 70mm-Black
230/7	BS01	3mt sensitive edge-H 70mm-Black
230/8	BS01	4mt sensitive edge-H 70mm-Black

CODE	DESCRIPTION
BS01-C15NG	1,5mt sensitive edge - H 70mm -Black/ Yellow
BS01-C17NG	1,7 mt sensitive edge - H 70mm -Black/ Yellow
BS01-C20NG	2 mt sensitive edge - H 70mm -Black/ Yellow
BS01-C25NG	3 mt sensitive edge - H 70mm -Black/ Yellow
BS01-C30NG	Bordo sensibile da da 3 mt - H 70mm Giallo/Nero
BS01-C40NG	4 mt sensitive edge - H 70mm -Black/ Yellow



CODE	DESCRIPTION
BPM0-S50NE	Hand protection edge - 5 mt kit

CODE	MODEL	DESCRIPTION
CP20-S30	CP20	3mt low profile passive edge-H 30mm
CP20-S40	CP20	4mt low profile passive edge-H 30mm
CP20-S50	CP20	5mt low profile passive edge-H 30mm



CODE	DESCRIPTION
BS10-C15NE	Edge with end in soft and shock-sensitive material - 1,5 mt - H 75 mm - Black
BS10-C17NE	Edge with end in soft and shock-sensitive material - 1,7 mt - H 75 mm - Black
BS10-C20NE	Edge with end in soft and shock-sensitive material - 2 mt - H 75 mm - Black
BS10-C25NE	Edge with end in soft and shock-sensitive material - 2,5 mt - H 75 mm - Black
BS10-C30NE	Edge with end in soft and shock-sensitive material - 3 mt - H 75 mm - Black
BS10-C40NE	Edge with end in soft and shock-sensitive material - 4 mt - H 75 mm - Black

CODE	DESCRIPTION
BP10-C15NE	1,5 mt passive edge - H 75 mm - Black
BP10-C20NE	2 mt passive edge - H 75 mm - Black
BP10-C30NE	3 mt passive edge - H 75 mm - Black
BP10-C15NG	1,5 mt passive edge - H 75 mm - Black/ Yellow
BP10-C20NG	2 mt passive edge - H 75 mm - Black/ Yellow
BP10-C30NG	3 mt passive edge - H 75 mm - Black/ Yellow



CODE	MODEL	DESCRIPTION
232	CP30	2mt low profile sensitive edge-H 30mm
233	CP30	2,5 mt low profile sensitive edge-H 30mm
234	CP30	3mt low profile sensitive edge-H 30mm
235	CP30	3,5mt low profile sensitive edge-H 30mm
236	CP30	4mt low profile sensitive edge-H 30mm
237	CP30	5mt low profile sensitive edge-H 30mm
CP30-KL3	KL3	3-sided kit for divisions



# SIGNALING



CODE	MODEL	DESCRIPTION
23/8	WAVE LED	LED Flashing light 12/24/230V - Different type of flashing
23/4	BASE WAVE	Wall fixing base



CODE	MODEL	DESCRIPTION
Z23	WHITE	Steady flashing light 230VAC - Fixing base
Z25	BLACK	Steady flashing light 230VAC - Fixing base

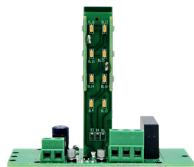

CODE	DESCRIPTION
ER-LED	24/230V LED module
ER-LED-S	24/230V LED module with buzzer



CODE	DESCRIPTION
K-M-LED12/24V	24/230V LED module with aerial
K-M-LED230V	230V LED module with aerial

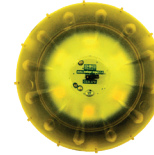

CODE	MODEL	DESCRIPTION
CS3137/B	LAR-3	12/24V wall flashing light

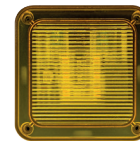

CODE	MODEL	DESCRIPTION
550/1036	ALF-G	12/24V/230V wall flashing light

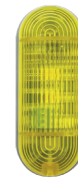

CODE	MODEL	DESCRIPTION
550/1040	MICRO-T	Wall micro-traffic light, 2 lights -Red-green - 12/24V



CODE	MODEL	DESCRIPTION
550/1041	MICRO-T	12/24V signaling module - Red

Automation Accessories | **Signaling**



CODE	MODEL	DESCRIPTION
550/1045	MICRO-T	Wall micro-traffic light, 2 lights -Red-green - 12/24V



CODE	MODEL	DESCRIPTION
550/3018	SEM-2	Traffic light, 2 lights - Red-Green - 12/24V



CODE	MODEL	DESCRIPTION
550/3040	SEM-1	Traffic light 1 light - Red - 12/24V

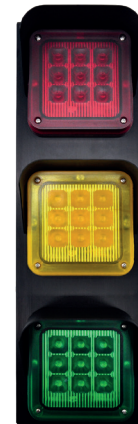

CODE	MODEL	DESCRIPTION
550/3025	SEM-3	Traffic light, 3 lights - Red, Yellow, Green - 12/24V



CODE	MODEL	DESCRIPTION
550/3050	SEM-1	Traffic light 1 light - Green - 12/24V



CODE	MODEL	DESCRIPTION
511/2050	QUAD	230V traffic light control board



CODE	MODEL	DESCRIPTION
550/3012	CONV	230/12V converter

# MECHANICAL



CODE	MODEL	DESCRIPTION
167/V	VDS-VL	Vertical electric lock 12V - 3 keys supplied



CODE	MODEL	DESCRIPTION
ELT6-220	ELT220	Drop electric lock 230V
ELT6-24	ELT24	Drop electric lock 24V
ETL6-12	ELT12	Drop electric lock 12V



CODE	MODEL	DESCRIPTION
167/E	ELC	Complete central left/right electric lock 12V - With button - 3 keys supplied



CODE	MODEL	DESCRIPTION
167	ELT	Complete central left/right electric lock - With button 12V - 3 keys supplied
168/1	ELT-BASE	Iron fixing base



CODE	MODEL	DESCRIPTION
167/1	A721	Complete central left/right electric lock 12V - Without
167/2	A731	Complete central left/right electric lock 12V - With button
107022100	BSTP	Booster Plus
107022000	BST	Booster
107023000	MICRO	Microswitch
107025100	BOB	Coil 12V

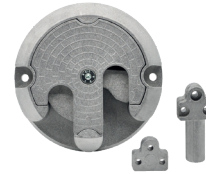

CODE	MODEL	DESCRIPTION
755	BL2	Vertical leaf block- In die-cast aluminum to be used in combination with an electric lock with operator without mechanical lock with aluminum pin



CODE	MODEL	DESCRIPTION
265	BL1	Vertical leaf block - In galvanized steel and B14 bronze to be used in combination with an electric lock with actuator without mechanical lock

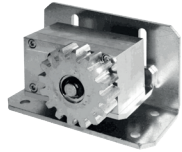

CODE	MODEL	DESCRIPTION
RVS	RVS	Slowdown system for sloping gates



CODE	MODEL	DESCRIPTION
216/1	CRM2	Nylon rack with metal insert - Complete with accessories - 1 mt - Black
216/G	CRM2	Nylon rack with metal insert - Complete with accessories - 1 mt - Grey
216/GL	CRM2	Nylon rack with metal insert - Complete with accessories - 1 mt - Yellow
216/B	CRM2	Nylon rack with metal insert - Complete with accessories - 1 mt - White

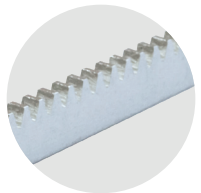

CODE	MODEL	DESCRIPTION
217	CRZ	Galvanized rack M4 - 30x12 complete with spacers - 1 mt



CODE	MODEL	DESCRIPTION
218	CRZ 8	Galvanized rack M4 - 30x8 complete with spacers - 1 mt

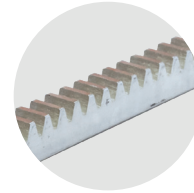
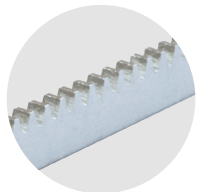

CODE	MODEL	DESCRIPTION
218/1	CRZ B	Galvanized rack M4 - 22x22 - 1 mt
218/2	CRZ B2	Galvanized rack M4 - 22x22 - 2 mt

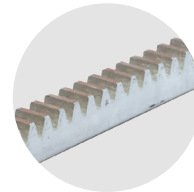

CODE	MODEL	DESCRIPTION
303001	CRZ S	Galvanized rack M6 - 30x30 - 1 mt
303001/1	CRZ S2	Galvanized rack M6 - 30x30 - 2 mt



CODE	MODEL	DESCRIPTION
DAP	DAP	Adjustable screw-on spacer - Pack of 3 pcs



CODE	MODEL	DESCRIPTION
STAFFAPIU	EASY	Adjustable screw-on spacer - Pack of 3 pcs



CODE	MODEL	DESCRIPTION
121032	NT1	Pawl to be welded

CODE	MODEL	DESCRIPTION
113022	NT2	Latch to be screwed on

# GENERIC



CODE	MODEL	DESCRIPTION
273	CLA 15	Aluminum column for Tech2 photocells - H 15cm



CODE	MODEL	DESCRIPTION
244	CLA 50	Column in anodized aluminum-H50mm
248	CLA 100	Column in anodized aluminum-H100mm
244/E	CLA G	Grey column - H 50 cm
244/B	CLA N	Black column - H 50 cm
244/C	CLA B	White column - H 50 cm
124569	CLA C	Fixing plate for column - H 50 cm

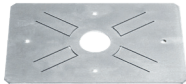

CODE	MODEL	DESCRIPTION
272	CSELL	Aluminum column with selector - H 100 cm
272/1	CSELL F	Aluminum column with selector - H 100 cm - Predisposition for photocells
248/2	100-2	Aluminum column - H 100 cm - Predisposition for double photocell
124569	CLA C	Fixing plate for column

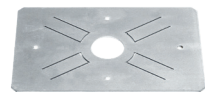

CODE	MODEL	DESCRIPTION
COLO50	CLN	Universal column in aluminum-H 50cm
COLO100	CLN	Universal column in aluminum-H 100cm
COLO120	CLN	Universal column in aluminum-H 125cm
ADT-INC	CLN-INC	Built-in adapter
CLN8-PB	B-CLN	Column base
CLN8-PST	B-CNT	Fixing plate



CODE	MODEL	DESCRIPTION
PFC1	FC	Setback with pole



CODE	MODEL	DESCRIPTION
PFC2	FCP	Wall stop



CODE	DESCRIPTION
420/2	12V battery - 1,2 AH - For Simply / Carrera / Speed



CODE	DESCRIPTION
420	12V battery - 7 AH - For Bev2 / Berta



CODE	DESCRIPTION
420/1	12V battery - 2 AH



CODE	DESCRIPTION
23	Battery for remote control E010-12V-23A
25	Battery for remote control - 12V - 27A



CODE	DESCRIPTION
24	Lithium battery - CR 2032 3V - For remote control Tx01/Tx02
26	Lithium battery - CR 2016
27	Lithium battery - CR 1620



CODE	DESCRIPTION
OKITMI5-PR	Blueforce Smart Kit - Impact force measurement instrument



CODE	DESCRIPTION
RN0250	Cable for gates - 2X0,50 - 100 mt skein
RN0450	Cable for gates - 4X0,50 - 100 mt skein
RN0550	Cable for gates - 5X0,50 - 100 mt skein
RN0210	Cable for gates - 2X1,00 - 100 mt skein
RN0410	Cable for gates - 4X1,00 - 100 mt skein
RN0315	Cable for gates - 3X1,50 - 100 mt skein
RN0415	Cable for gates - 4X1,50 - 100 mt skein



CODE	DESCRIPTION
PG1M9W01	Emergency button - Ø 90 mm - Red - NC contact - Wall mounting



CODE	DESCRIPTION
165B	Warning sign



CODE	DESCRIPTION
PG8M9W10	Control button - Ø 90 mm - Black - NA contact - Wall mounting



CODE	DESCRIPTION
19/O	Dielectric hydraulic oil - 1 lt
19/P	Dielectric hydraulic oil - 2 lt
19/Q	Dielectric hydraulic oil - 5 lt



CODE	DESCRIPTION
AC01-100	Galvanized cabinet with key for control board



CODE	DESCRIPTION
CC2750154	Spare cable set for overhead doors



CODE	DESCRIPTION
AC01-200VA	Support for control board

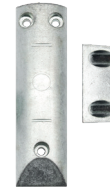

CODE	DESCRIPTION
ST-450	Magnetic contact for overhead door

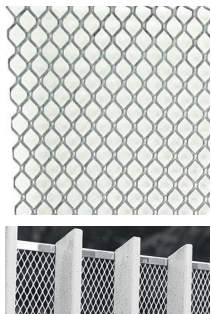

CODE	DESCRIPTION	
RT-H100	Expanded mesh for motorized openings and gates Compliant with CEI EN 60529 - H 100	mt
RT-H125	Expanded mesh for motorized openings and gates Compliant with CEI EN 60529 - H 125	mt
RT-H150	Expanded mesh for motorized openings and gates Compliant with CEI EN 60529 - H 150	mt
RT-H200	Expanded mesh for motorized openings and gates Compliant with CEI EN 60529 - H 200	mt
PR-RT	Profile for finishing - 3 mt	

# TECHNICAL FEATURES

## DIGITAL KEYBOARD

---

Available programs:

- Entry
- Exit
- Normal
- Partial
- Open
- Closed

## CART

---

- Made of sturdy laser-cut steel laminate
- Supporting wheels in technopolymer molded directly on the bearing
- Anti-slip system with adjustable metal elements

## POWER SUPPLY

---

Composition: 120 VA transformer in box and protected by fuse

## OPERATOR UNIT

---

- 24 VDC motor, drive shaft supported by ball bearing
- Double reading optical encoder 100 pulses
- Die-cast aluminum wheel drive
- Locking system made by an industrial solenoid mounted directly on the return wheel operable by a steel cable

## CONTROL UNIT

---

- Microprocessor with built-in battery charger management and removable terminals
- Interlocking management
- Anti-crushing safety
- Slowdown speed adjustment on the board
- Remote programming via digital selector JET01
- Security tests
- Air curtain management

# CHART WORKS

- Feature included
- Feature not included

	EURO 230 M2	EURO 230 M2 MINI	ELB 24 M2	EURO 230 M1	EURO 24 M1
MOTOR SUPPLY	230 VAC	230 VAC	24 VCC	230 VAC	24 VCC
MOTORS	2	2	2	1	1
MOTOR ACCESSORIES	●	●	●	●	●
SAFETY SUPPLY	●	●	●	●	●
START INPUT	●	●	●	●	●
PEDESTRIAN INPUT	●	—	●	●	●
STOP INPUT	●	●	●	●	●
LIMIT SWITCH INPUT	●	—	—	●	●
PHOTOCELLS INPUT	●	●	●	●	●
SAFETY EDGE INPUT	●	●	●	●	●
SENSOR RPM INPUT	—	—	—	●	●
PLUG-IN RADIO INPUT	—	—	●	—	—
ON BOARD RADIO RECEIVER	●	●	●	●	●
FLASHING INPUT	●	●	●	●	●
COURTESY LIGHT INPUT	●	—	—	●	●
ELECTRO LOCK INPUT	●	●	●	—	—
STEP BY STEP	●	●	●	●	●
STEP BY STEP WITH STOP	●	●	●	●	●

Chart Works

- Feature included
- Feature not included

	EURO 230 M2	EURO 230 M2 MINI	ELB 24 M2	EURO 230 M1	EURO 24 M1
CONDOMINIUM	●	●	●	●	●
DEAD MAN	—	—	—	—	—
RAM PUSH	●	●	●	—	—
AUTOMATIC CLOSER	●	●	●	●	●
FASTER CLOSER	—	—	—	—	—
PHOTOCELLS IN OPENING	●	●	●	●	●
PHOTOCELLS IN CLOSING	●	●	●	●	●
TORQUE ADJUSTING	●	●	●	●	●
SLOW DOWN	●	●	●	●	●
ANTI-CRUSHING	●	—	●	●	●
EXTENSION WORKING TIME	●	●	●	●	●
BATTERY INPUT	—	—	●	●	●
SOLAR PANEL INPUT	—	—	●	●	●
THREE-PHASE SWITCH	—	—	—	—	—
PHOTOCELL TEST	—	—	—	—	—
FREQUENCY 433 MHZ	●	●	●	●	●
HYDRAULIC BLOCK MAINTENANCE	●	●	—	—	—

# CHART WORKS

- Feature included
- Feature not included

	EURO 380 M1	Q 100 INVERTER	ROLLY	MINI	AT 7070
MOTOR SUPPLY	230 / 380 VAC	230 / 380 VAC	230 VAC	230 VAC	24 VCC
MOTORS	1	1	1	1	1
MOTOR ACCESSORIES	●	●	●	●	●
SAFETY SUPPLY	●	●	●	●	●
START INPUT	●	●	●	●	●
PEDESTRIAN INPUT	●	●	—	—	●
STOP INPUT	●	●	—	—	●
LIMIT SWITCH INPUT	●	●	—	—	●
PHOTOCELLS INPUT	●	●	●	●	●
SAFETY EDGE INPUT	●	●	—	—	—
SENSOR RPM INPUT	—	—	—	—	●
PLUG-IN RADIO INPUT	●	—	—	●	—
ON BOARD RADIO RECEIVER	●	—	●	●	●
FLASHING INPUT	●	●	—	●	●
COURTESY LIGHT INPUT	●	—	—	—	●
ELECTRO LOCK INPUT	—	—	—	—	—
STEP BY STEP	●	●	●	●	●
STEP BY STEP WITH STOP	●	●	●	●	●

Chart Works

- Feature included
- Feature not included

	EURO 380 M1	Q 100 INVERTER	ROLLY	MINI	AT 7070
CONDOMINIUM	●	●	—	—	●
DEAD MAN	●	●	●	●	—
RAM PUSH	—	●	—	—	—
AUTOMATIC CLOSER	●	●	●	●	●
FASTER CLOSER	—	—	—	—	—
PHOTOCELLS IN OPENING	●	●	—	—	—
PHOTOCELLS IN CLOSING	●	●	●	●	●
TORQUE ADJUSTING	●	●	—	—	●
SLOW DOWN	●	●	—	—	●
ANTI-CRUSHING	●	●	—	—	●
EXTENSION WORKING TIME	●	●	●	●	●
BATTERY INPUT	—	—	—	—	●
SOLAR PANEL INPUT	—	—	—	—	●
THREE-PHASE SWITCH	●	—	—	—	—
PHOTOCELL TEST	—	—	—	—	—
FREQUENCY 433 MHZ	●	—	●	●	●
HYDRAULIC BLOCK MAINTENANCE	—	—	—	—	—

# GENERAL SALES CONDITIONS

## PURCHASING ORDERS

Placing a purchase order implies the acceptance of the following General Conditions of Sale:

## ARTICLE 1: DELIVERY TERMS, TRANSPORT AND PACKAGING

---

The goods mentioned in the contract is sold ex-works. Shipment, only if required by the buyer, might be effected by transport agent named by VDS if not differently specified. All freight charges and any risks are to be considered as buyer charge - the goods will be packaged according to VDS experience. VDS is totally exempt from any responsibilities for losses or damages for goods regularly package.

## ARTICLE 2: DELIVERY TERMS

---

VDS agrees with customers each time the standard delivery terms according to purchased goods, if not clearly indicated in the confirmaion of the orders. VDS furthermore accepts any eventual change in the standard delivery time and in case to communicate this change by order confirmation or in written document.

## ARTICLE 3: S CHANGES

---

The change in costs, also occurring during the supply, may determine the change in the agreed s.

## ARTICLE 4: CLAIMS

---

Claims against the quality of the goods or with reference to supplied goods must be sent to the address of the selling company by registered letter within and not further 8 days from the delivery date. No returns will be accepted unless by written authorization of VDS.

## ARTICLE 5: PAYMENT

---

The payment terms are those mentioned on the order confirmation and on the invoices issued from VDS. All the payments must be effected to the address of VDS. The delay in payment even only for part of the invoice, will cancel the discount if granted and will cancel any agreed delay of credit or delayed payment agreed terms even rate, starting from the expiry date of the agreed terms and in the suspension of further supplies. The charges for any eventual outstanding will be debited to the buyer. VDS is totally authorized to issue drafts against the buyer in order to collect the interest, even if claims or disputes are in process.

## ARTICLE 6: GUARANTEE: DURATION, EXTENSION, LIMITS

---

VDS guarantees his products and accessory components for a period of 2 years from the selling date, during which assistance is considered free. The replaced components will remain the property of VDS. All transport costs necessary for the provision of the guarantee in the forms mentioned above are the responsibility of the buyer. VDS reserves the right to refuse the guarantee if:

- The electric accessories and automation components have been used without observing the standard connection diagrams which have been designed for.
- The gearmotors have been used for uses other than those established.
- The assembly and electrical connection instructions have been applied inconsistently with the screens contained in the packaging of the goods.
- Maintained contact pushbutton panels or key selectors have been used for several gearmotors or with a single command.
- No connections have been made according to UNI / CE regulations
- The gearmotors have been disassembled or manipulated without the written authorization of VDS.

After the warranty terms have elapsed, assistance will be carried out by authorized personnel, for a fee and on the basis of a defined tariff, for interventions, based on the tables issued by the Civil Engineers and, for spare parts based on the latest revision. of the internal VDS lists.

## ARTICLE 7: LEGAL COURT

---

In case of disputes, the legal court is established in Pescara.

VDS IS NOT RESPONSIBLE IN CASE OF BAD WEATHER CONDITION ACCIDENTS AND ANY ACCIDENTAL ACTION OR VANDALS ACCIDENTS. ALL INFORMATION REPORTED, ARE SIMPLY INDICATIVES. VDS RESERVES ITS RIGHTS TO MODIFY PRODUCTS WITHOUT FURTHER COMMUNICATION. THE PRESENT LIST CANCELS AND SUBSTITUES THE PREVIOUS.



**ITALIA**  
**VDS AUTOMAZIONI SRL**

Via Circolare pip n. 10  
65010 Spoltore (PE) – Italy  
P.IVA 02269220683  
TEL: +39 085 497 1946  
FAX: +39 085 497 3849  
www.vdsautomazioni.com  
info@vdsautomation.com

**SPAGNA**  
**VDS AUTOMATISMOS IBERICA**

Calle Sierra Carbonera, 24  
28500 Arganda del Rey,  
Madrid - Spain  
TEL: +34 918 706 760  
FAX: +34 618 356 558  
info@vdsautomatismos.es

 Vds Automation Automazioni

 vds\_automation

 +39 331 234 2963

 VDS Automation

 VDS Automation

