



Software News

June 30th, 2026

EAW Resolution v2.13.0.45 Release Notes

Previous Version: [EAW Resolution v2.12.2.31](#)

General Features and improvements

- SPL Color Map selection and creation, fixed and adjustable limits supported
- Network Configuration dialog for network interface selection of Dante Primary/Secondary and amplifier discovery. Also detects network conditions and unsupported configurations.
- Report An Issue feature can gather useful Resolution and networking information for analysis by EAW Service
- Network connectivity and stability improvements
- Back panel switch handling for NT speakers in Acoustic View, supports auto configuration and locking of switches

New Hardware Support

- NT208L family: NT208L, NT208L-Stinger, NT208L-Frame, NT208L-SubMount, NT208L-Pullback, NT208L-Feet
- NT116S family: NT116S Flybar and NT206L Transition Bar
- Preset Library 2.3 now includes the AX speaker famil

General Fixes & Stability

- SBX118/118F/218: Corrected limiter metering point
- Otto coverage pattern drag direction and angle limit corrected
- Preset load/save directory now defaults to the correct roaming folder
- AC6 speaker dimensions measurement accuracy improved
- Product weights updated to match spec sheet values (MKC, MKD, SB210, Otto)
- RSX/NTX/SBX Crossover frequency no longer resets when the equalizer is opened

EAW Resolution v2.12.2.31 Release Notes

Previous Version: [EAW Resolution v2.12.1.35](#)

General Features and improvements

- Venue Detection per array
- EQ Window item navigation (allowing for next/previous item)
- AC6 and Otto Ground stack and pole mount support



New Data Files

- AC6 Base Plate and AC6 Locking Plate
- AC6 Pole Mount
- Otto Flybar Lite

Bug fixes

- UXA4401/4403/4807 Reset indicator widgets to defaults, on main amplifier page, when connection is broken.
- Allow Parameter Sync Dialog to be closed if the network changes while uploading parameters.
- Horizontal Coverage property was always zero for line arrays without adjustable coverage.
- Fixes for possible crashes on ADAPTive speakers when uploading parameters.
- Spatial Equalization start/end lines pointed to Y=0 instead of along aim line.

EAW Resolution v2.12.1.35 Release Notes

Previous Version: [EAW Resolution v2.12.0.78](#)

General Features and improvements

- AC6 Inverted Support
- NT206L
 - Asymmetric Horizontal Coverage support (110+80, 80+110)
 - NT206L Pullback support
- Otto
 - New RED voicing with 75/100% rejection compatibility.
 - Meter refresh rate increased to 80ms (when using FW 1.0.13.0 or later).
- Inventory Manager shows and auto-checks new products on new install
- UXA4403/4807 preset library 2.18 adds SB528z
- Array Assistant Type A/B name completion filtering.
- Installer and Executable code signing. EAW is now a known publisher.

Firmware Updates

- NT206L v1.0.7
- Otto v1.5.22

Bug fixes

- Firmware Update improvements
- Network View analog meters levels were too low, and meter color could be wrong when muted.
- UXA4401/4403/4807 improved networking reliability, error recovery.
- Design View Venue Detection may show incorrectly when ear height intersects speaker length.
- Design View Coverage Pattern may be incorrect for mixed arrays with subs.



EAW Resolution v2.12.0 Release Notes

Previous Version: [EAW Resolution v2.11.2.2](#)

General Features and improvements

- Resolution
 - UXA4401, UXA4403, UXA4807 amplifier support
 - Added Dark Mode
- UXA Install Amplifier Support
 - Speaker Library : UXA4401 v23, UXA4403/4807D v2.17
 - Dante Support
- NTX, SBX, RSX Series
 - NTX, SBX Improved Voicings
 - Back Panel Unmute
 - Fix MAC address errors
 - Improved orientation support for subs

Firmware updates

- AC6
 - Updated Firmware v1.0.43
 - Includes ADAPTive API for external device control
- Anna
 - Updated Firmware 1.0.34.0
 - Includes ADAPTive API for external device control
- Anya
 - Updated Firmware 1.1.9.0
 - Includes ADAPTive API for external device control
- Otto
 - Updated Firmware 1.0.21.0
 - New RED voicing “optimized for maximum output with impulse based sources (i.e. Kick Drum).”
 - Includes ADAPTive API for external device control
- UXA Install Amplifiers
 - Firmware Version 1.7.4
- UXA4416
 - Firmware v1.5.1
 - Includes additional products
 - Gain structure is now consistent across all products
 - Improved limiter
- RSX, NTX, SBX Firmware updates
 - Firmware 1.3.16.0
 - New voicings
 - Back panel unmute
 - MAC address validation widens support for latest EAW Macs
 - Improved orientation support for subwoofers
 - Added SBX118F support



Datafile Updates

- NT206L
 - NT206I
 - NT206L Stinger
 - NT206L Frame
 - NT206L feet
 - NT206L Pole Mount
 - NT206L Sub Mount
 - Generic Pole (50kg low height, 50kg mid height, 50 kg high height)

EAW Resolution v2.11.2.2 Release Notes

Previous Version: EAW Resolution v2.11.1.19

General Features and improvements

- UX4416 Support v19 firmware Dante changes
- AC6 Coverage Improvements

EAW Resolution v2.11.1.19 Release Notes

Previous Version: EAW Resolution v2.11.0.80

General Features and improvements

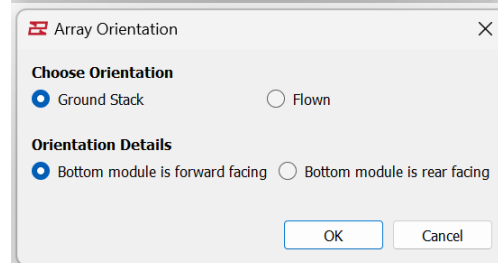
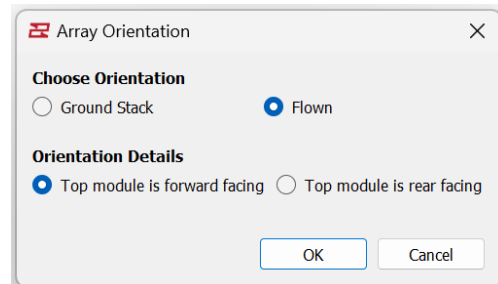
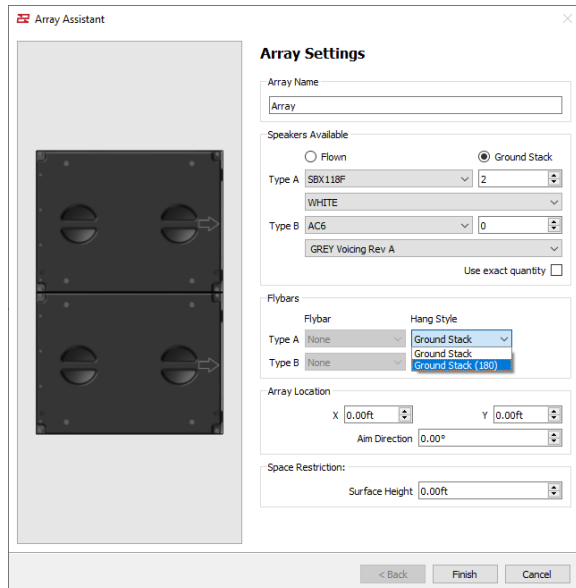

Features:

RSX18F, SBX118F orientation detection (forward/back) for cardioid.

- Orientation read from speaker in relation to topmost speaker (bottom in Groundstack).



- Ability to set orientation direction of array in Resolution.
- Update Firmware for RSX18F/SBX118F to report orientation information (to Resolution 2) when requested.
- Orientation discovered at power up of RSX18F and SBX118F modules.

Data File Updates

- SB828
 - Connects to Suspension Adapter, Ground Stack Adapter, NTX210L Flybar
 - Connects to AC6 Ground Stack Plate
- SB818
 - Connects to Suspension Adapter, Ground Stack Adapter, NTX210L Flybar
 - Connects to AC6 Ground Stack Plate
- SBX118F
 - Connects to Suspension Adapter, Ground Stack Adapter, NTX210L Flybar
 - Connects to AC6 Ground Stack Plate
- SBX118
 - Connects to AC6 Ground Stack Plate
- SBX218
 - Connects to Suspension Adapter, Ground Stack Adapter, NTX210L Flybar
 - Connects to AC6 Ground Stack Plate
- Suspension Adapter SB818 SBX118F
 - supports connection of KF210/NT210L to SB818/SBX118F
- Ground Stack Adapter SB818_SBX118F
 - supports connection of KF210/NT210L to SB818/SBX118F
- NTX210L Flybar
 - Add connection to SB818, SBX118F

General Features and improvements

- Updated UXA4416 firmware (presets included SB818, SB828, KF210 w/voicing changes).
- UXA4416 1.3.0 eawfw Firmware Update
 - Dante firmware update to default to Redundant switch mode.
 - Dante+Control can share the same back panel port.
 - Back panel port configuration is: Primary=1/3, Secondary 2,4.
- UXA4410, UXA4406, UXA4810 - Mute reset to unmuted on drag/drop with greybox present.
- Clear Dante Channel in input selection dialog when no device associated with Dante Source
- Remove the AL button for Otto in Project Explorer
- RADIUS - Support speaker rotation detection for updated

EAW Resolution v2.11.0.80 Release Notes

Previous Version: EAW Resolution v2.10.4.2



General Features and improvements

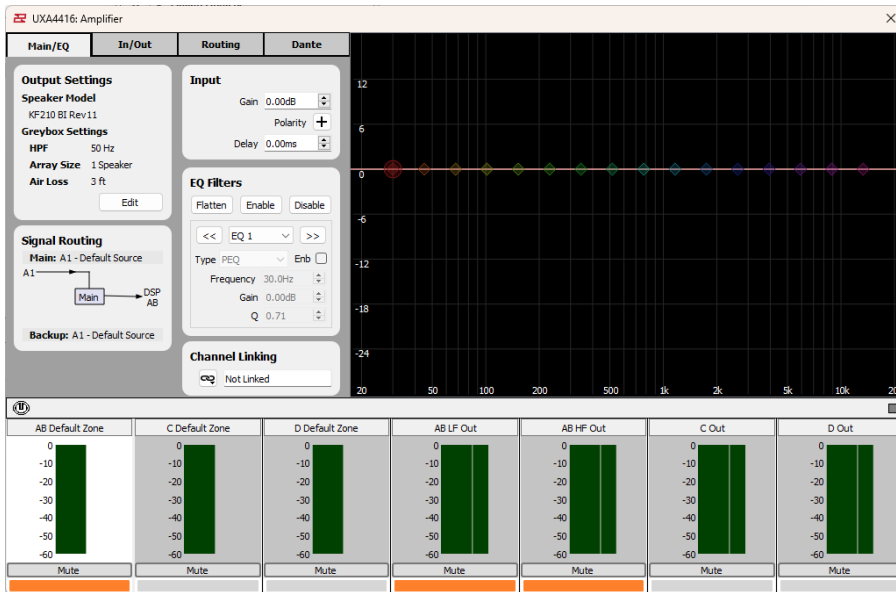

- Support for UX4416, including the following products:

1. MKD526
2. JF80z
3. KF210
4. KF810P
5. MKD1200 Series
6. MKD800 Series
7. SM12
8. MW12
9. MW15
10. SB828
11. SB818
12. SB528
13. SB1000
14. SB1001/SB1002
15. SB2001/SB2002

- Improvement to the Array Assistant and its GUI

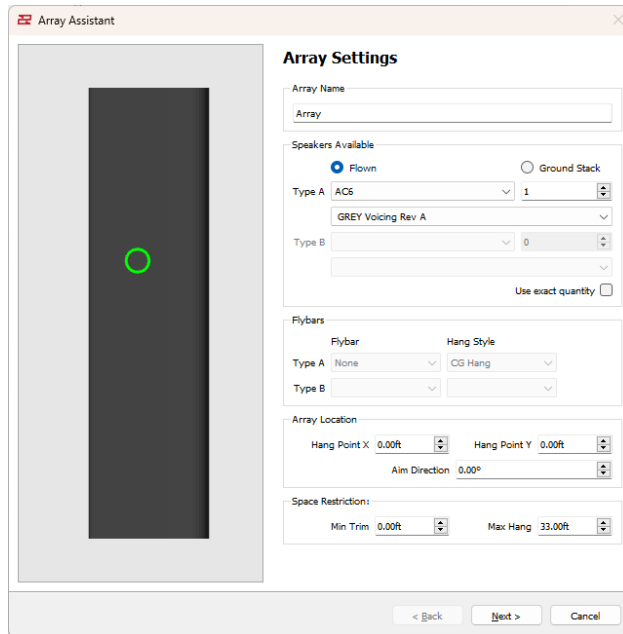

- RSX/NTX Firmware improved upgrade procedure
- Updated AC6 Firmware
- Improved AC6 Horizontal Mode Steering SPL display
- Improved AC6 Ground Stack support
- Updated KF210 Voicing

EAW Resolution v2.10.4.2 Release Notes

Previous Version: EAW Resolution v2.10.3.18

General Features and improvements

- Support for MKD1500 Series
- Support for LA Series
- Support for MK8196z

EAW Resolution v2.10.3.18 Release Notes

Previous Version: EAW Resolution v2.10.2.18

AC6 Stacking Plates & Stinger added

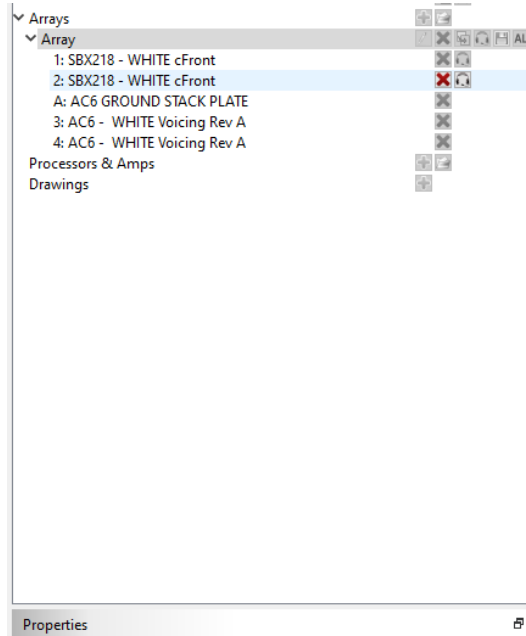
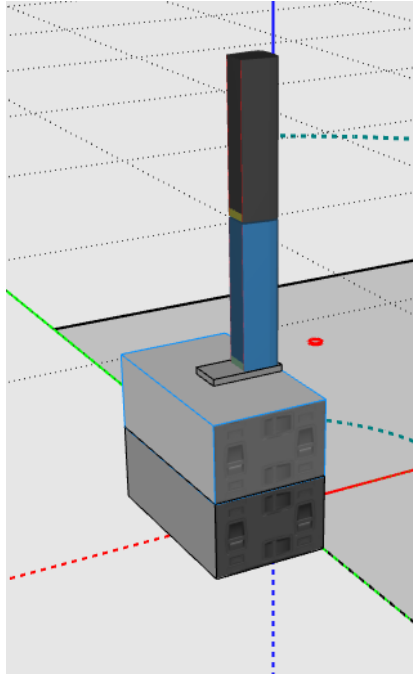

General Features and improvements

- Support for MKD526
- Updated Anna Firmware
- Updated AC6 Firmware
- General improvements to ADAPTiVe Systems functionality

EAW Resolution v2.10.2.18 Release Notes

Previous Version: EAW Resolution v2.10.1.16

Monitor Only Mode

In Monitor Only mode, the ability to modify a system is limited. This mode is useful after a system has been setup and you wish to prevent others from adjusting settings or parameters.

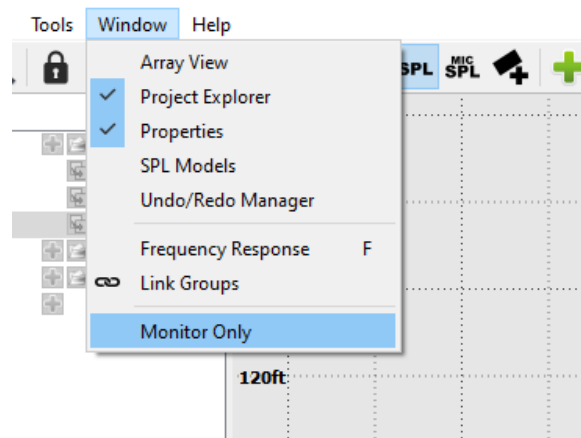

SPL Models support Upload Parameters for any model

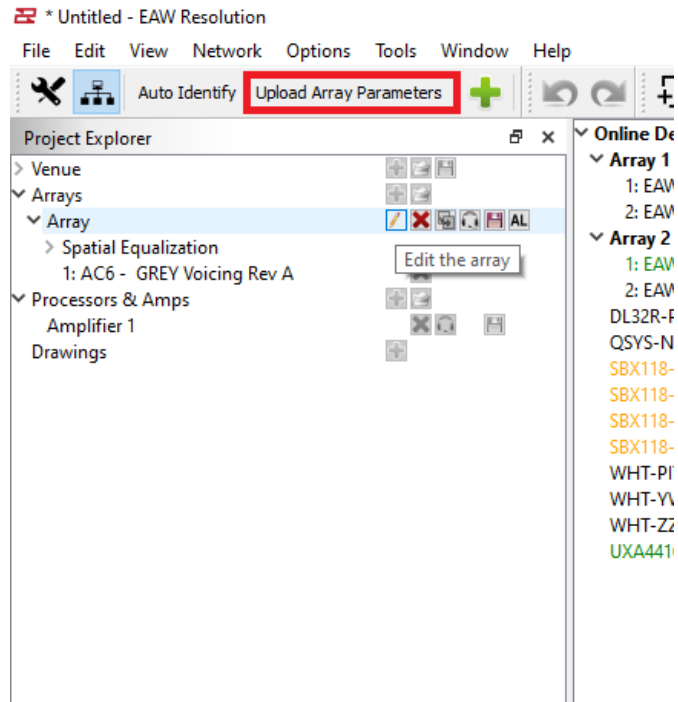

General Features and improvements

- Support for MKC Series & SB210 data files
- ADAPTive (ANNA/ANYA/OTTO) Firmware Updates
 - Stability Improvements
 - Static IP Support
 - Updates to the Brooklyn Chipset Firmware
- AC6 Firmware Updates
 - ADAPTive coverage accessible from back panel LCD (No computer required)
 - Recall Presets from back panel LCD
 - Other Improvements and updates to back panel LCD
- SPL Models: Cached spl items are only invalidated for the currently selected model
- Firmware update process for UX/UXA Series (v1.569)
 - Support for both DANTE Input & Output
 - Obtains DANTE ID – No longer requires manual unifying of devices (Unify Processors)
- SBX Firmware Updates
 - Back Panel updates and improvements
- Improve Equalizer drawing
- Fixed bug - dragging an array using the dragger label causes it to jump from cursor position

EAW Resolution v2.10.1.16 Release Notes

Previous Version: EAW Resolution v2.10.0.138

Added Support for KF210 Line Array

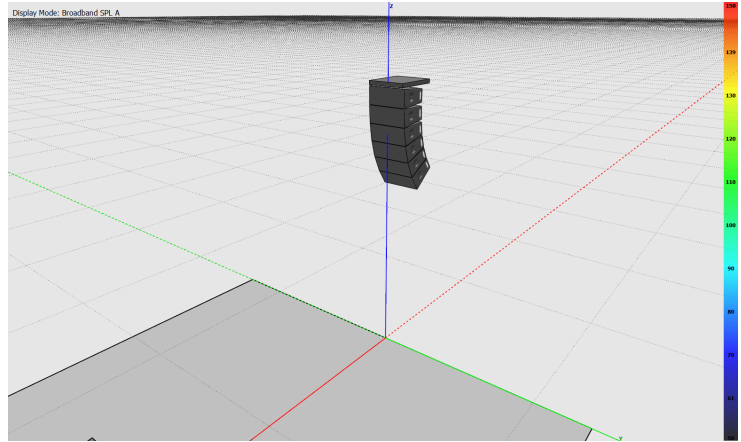

Updated Side View

Changes the Venue View to a defined X,Y location and rotational angle (the view is always vertical). This allows the view to be parallel to the aim line of an array, the center line of a surface, or arbitrary user defined position.

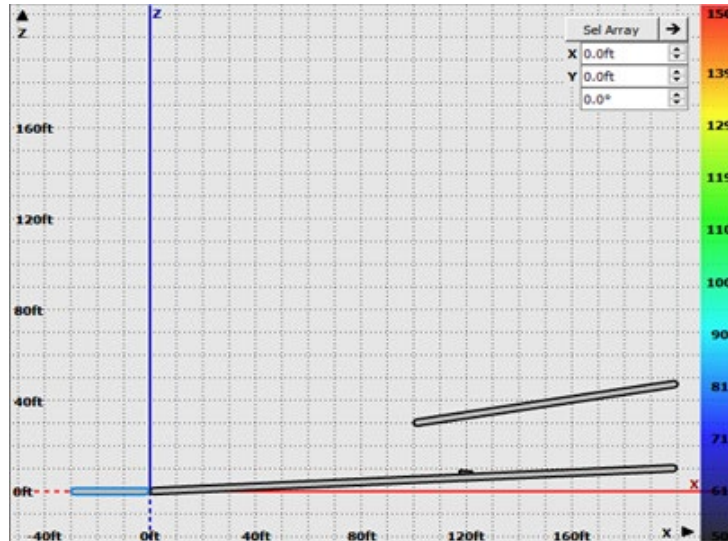

New SPL Models Feature

Arrays can be added to groups for specific SPL plots & mapping

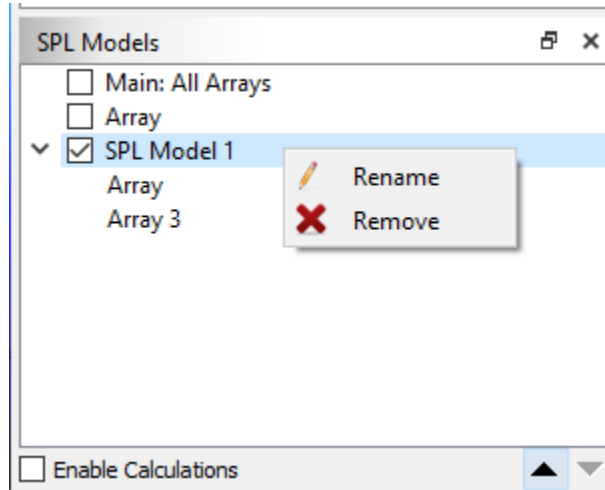

New SPL Distribution Chart

The SPL Distribution Dialog shows a chart of the SPL distribution as well as statistics computed from the data.

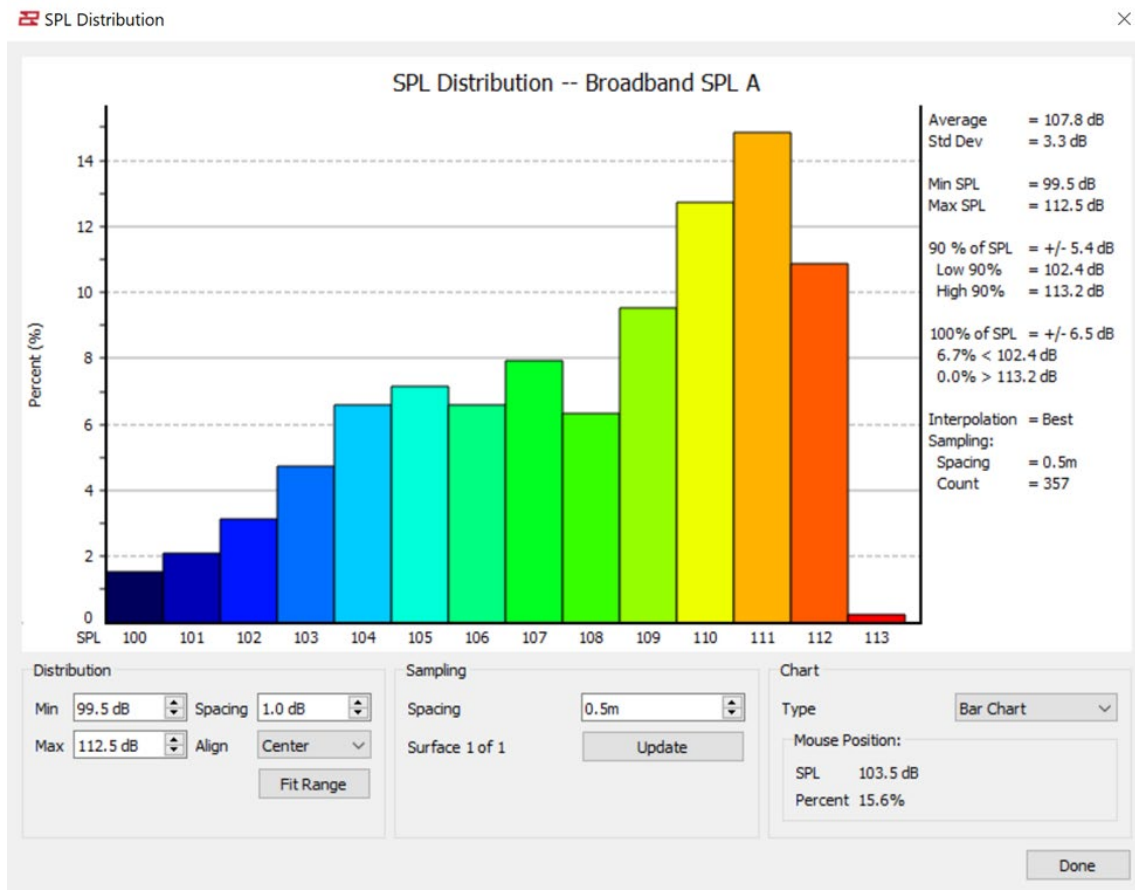

General Features and improvements

- Show/hide coverage pattern in Design View



- Export EASE xglc for selected item only
- UXA Export Debug Logs
- Improved Side View
- Added SPL Distribution Chart
- Added SPL Models Feature
- Improvements on AC6 Horizontal Mode
- Restructured View Menu, added new Window Menu

EAW Resolution v2.10.0.138 Release Notes

Previous Version: EAW Resolution v2.9.2.22

Added Network and Control Support for AC6

▼ Online Devices

AC6-DEMO

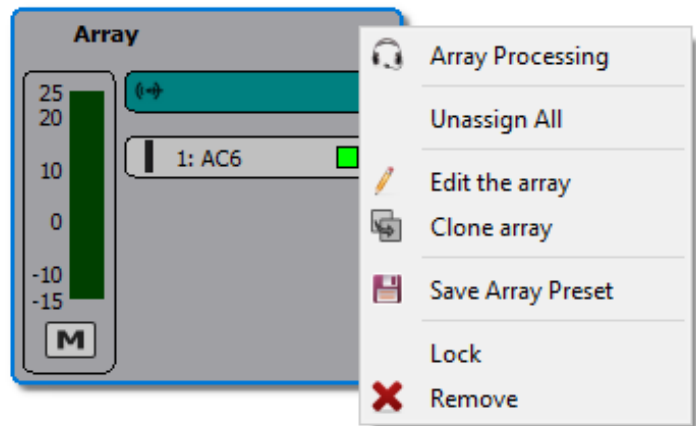

Improved Adaptive system health functionality

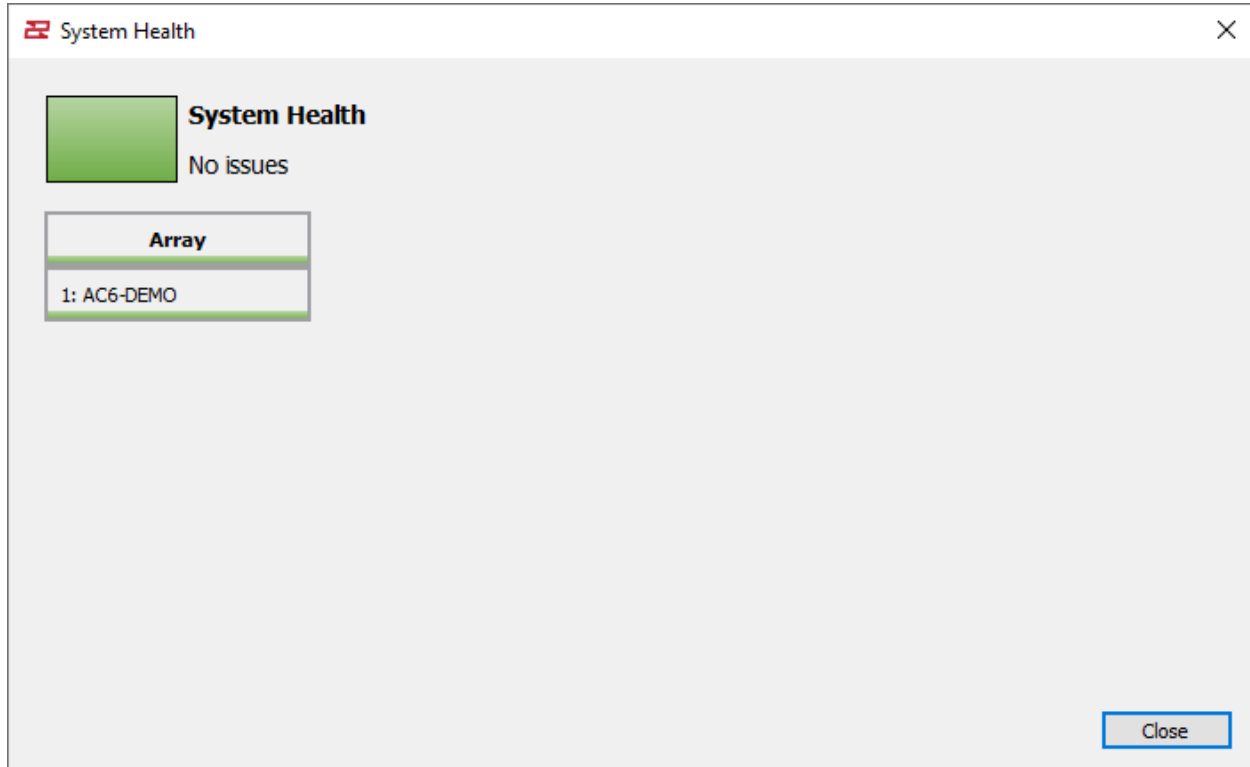

General Features and improvements

- Improved venue detection.
- Improved network communication for systems with a large amount of online devices.
- Fixed UX/UXA mute buttons in Network View.
- Improved firmware update process and reliability for daisy chained devices.
- Minor bug fixes for ADAPTive Air Loss.
- Remember which PEQ is selected when toggling inputs/outputs in Processor.
- Disable or Hide "Coverage & Modify Coverage" for Non-Adaptive Products.
- Resolution now should request and recognize the processor type in Radius hardware info response.

Firmware Updates

- Initial release of AC6 firmware
- SBX, NTX, RSX improved firmware to support latest hardware version
- Update Anya firmware that fixed a bug that could cause a momentary (2-3 seconds) audio mute or erroneous fault condition (rare case)

EAW Resolution v2.9.2.22 Release Notes

Previous Version: EAW Resolution v2.8.1.8

Added Network and Control Support for Radius

RSX12, RSX208L

RSX18, RSX18F, RSX212L

RSX86, RSX90



RSX126, RSX129
RSX218

Online Devices

Array 1

- 1: RSX208L-BPD1
- 2: RSX208L-BPD2
- 3: RSX208L-BPD3

DL32-HALTstation
DL32R-Pitlab
R1c-UXA-KF810-3
WHT-PIT-ONE

Array

20
10
0
-10
-20
-30
-40

auto

- 1: RSX208L
- 2: RSX208L
- 3: RSX208L

- Array Processing
- Unassign All
- Edit the array
- Clone array
- Save Array Preset
- Lock
- Remove

Radius Driver Test implementation

Diagnosics: ANVA-01

Overview | Meters | Maintenance | Temp Log | Impedance Log | Error Log | Acoustic Measurements

ANVA-01

Product: RSC208L
Software Version: 1.1-48.0
Firmware Version: 1.1-48.0
IP Address: 192.168.1.11
RX Channels: 0
RX Latency: 0
TX Channels: 0
TX Latency: 0
Roll: 0.0 degrees
Pitch: 0.0 degrees

LED Options

- Global
- Power On
- Identify
- Limit
- Fault
- Clip

Calibrate Tilt
Update Firmware
Reboot

Save

Diagnosics: RSK208L-BPD1

Overview

RSK208L-BPD1

Product: RSC208L
Product Version: 1.0.0
Software Version: 1.1-48.0
Firmware Version: 1.1-48.0
Dante Version: 2.2.3.1
IP Address: 169.254.151.11
MAC Address: 08:0d:1b:08:0b:8d
Dante IP Address: 169.254.151.4
Dante MAC Address: 00:1d:c1:00:04:96
RX Channels: 1
RX Latency: 1 ms
Angle: 0

LED Options

Logic LED: Off

Update Firmware
Reboot

Driver Test: Off

Test Type: Auto | LF | HF | LF

Level: 60.0 dB

Click "On" to start the test

Select Passband to test

Adjust the Level

Radius Array Optimize implementation



General Features and improvements

- Acoustic model and SPL recalculate less frequently for venue edits
- Network Stability Improvements for large scale systems
- Speed, responsiveness, and usability improvements for large systems
- Improved use of CPU and core split ups
- System Health and parameter upload improvements
- Bottom Height and clearance fields improved.
- Improved Firmware upload support (Including RSX Series Firmware)
- Improved support for "roll" of products
- Automatic reconnection to online devices after PC sleep mode restart
- Parameter copy/paste between processors and between channels
- Improved Undo/Redo feature.
- Added new Front View and ability to load front view elevation drawings.
- Resolution 2.8 will rotate the drawing 90 degrees if you resave the file.
- New data files for JF80z, JF60z, SB528z, SB250z, SB150z, SB180z, LS432i, LS832i, MK8126I, MK8196i.

EAW Resolution v2.8.1.8 Release Notes

Previous Version: EAW Resolution v2.8.0.37

Adaptive Venue Detection Mode: Narrow or Wide.

There is now a new option under the Options menu.

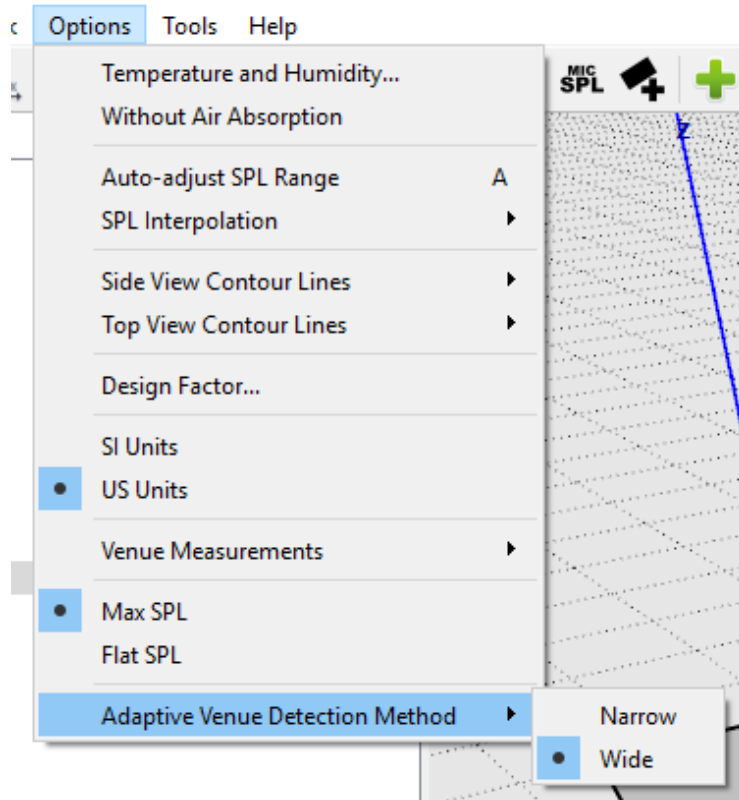

Example:

One 10-modula Anna array aimed down a typical venue. One side of the venue is show for illustrative purposes.

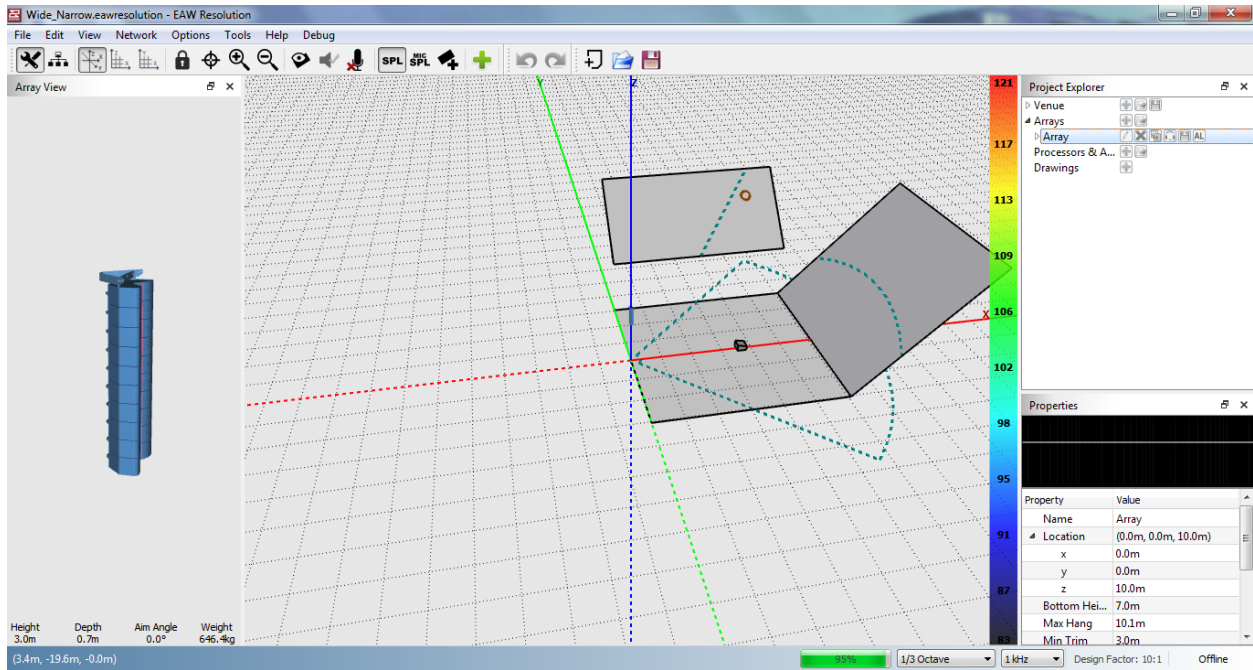

Here, the coverage is set to Wide

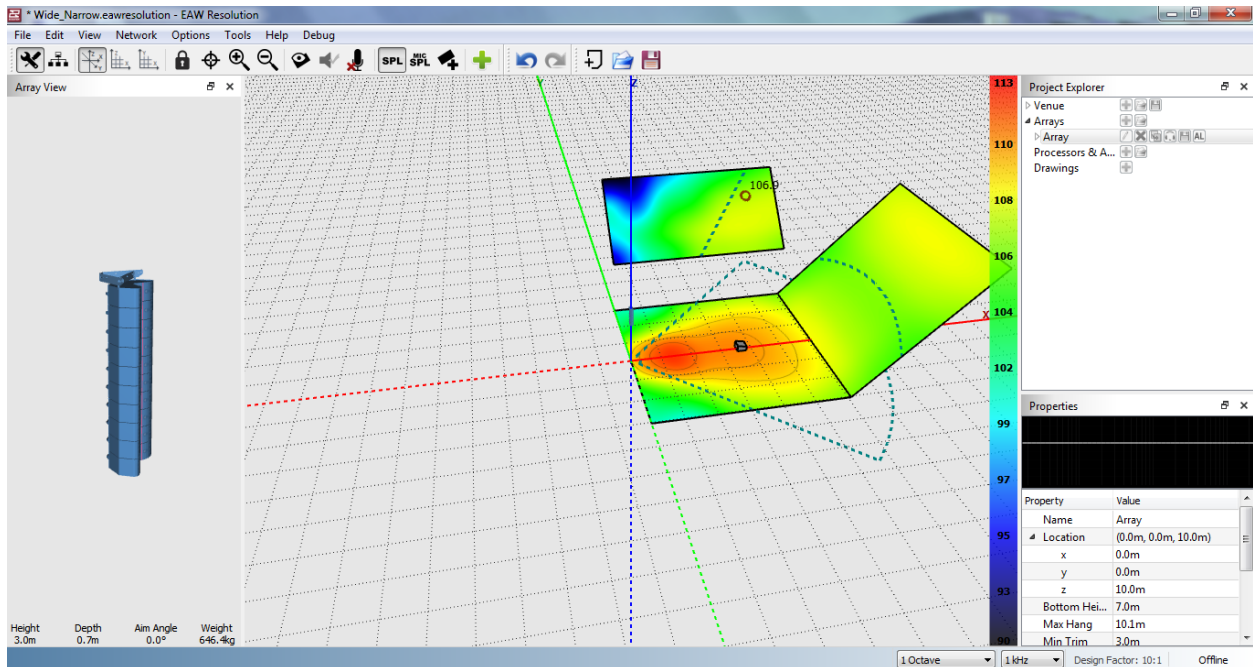

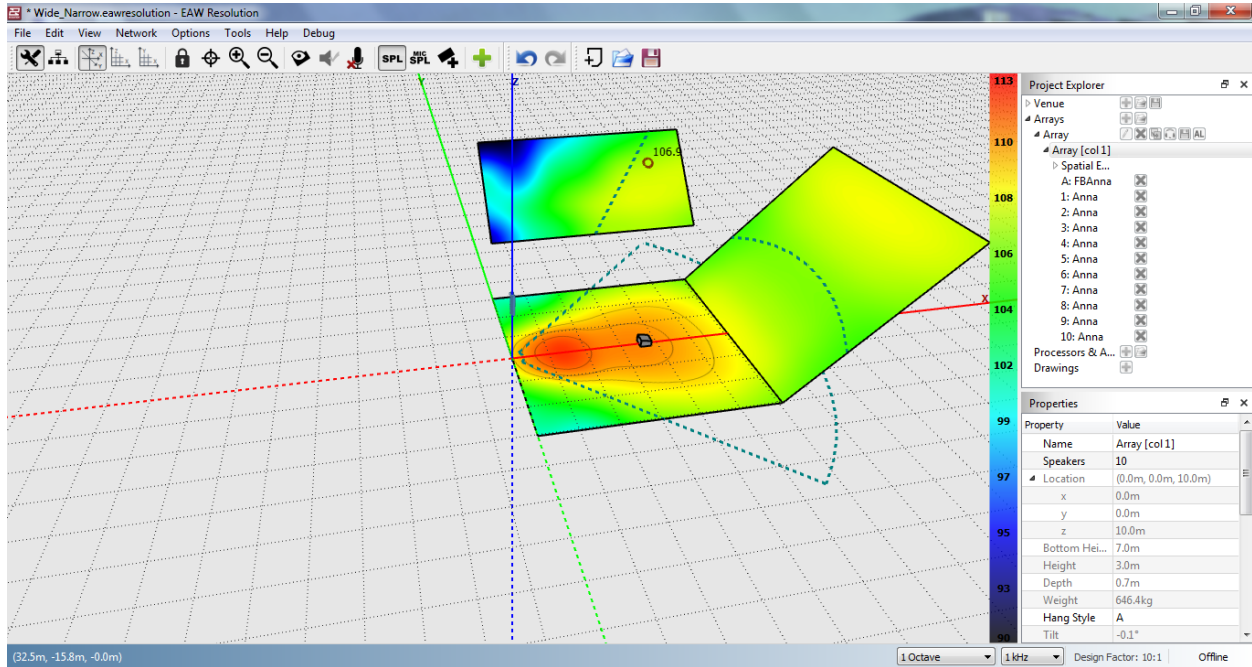

Coverage extends to the side of the arena.

In this next figure the coverage is set to Narrow.

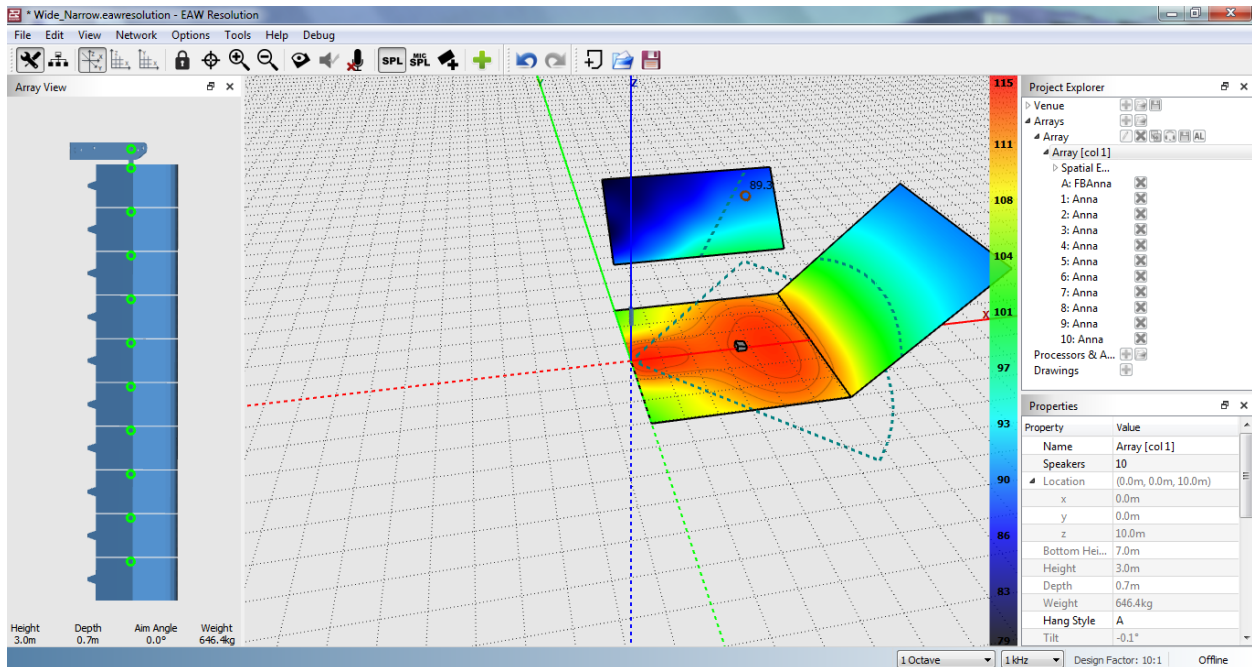

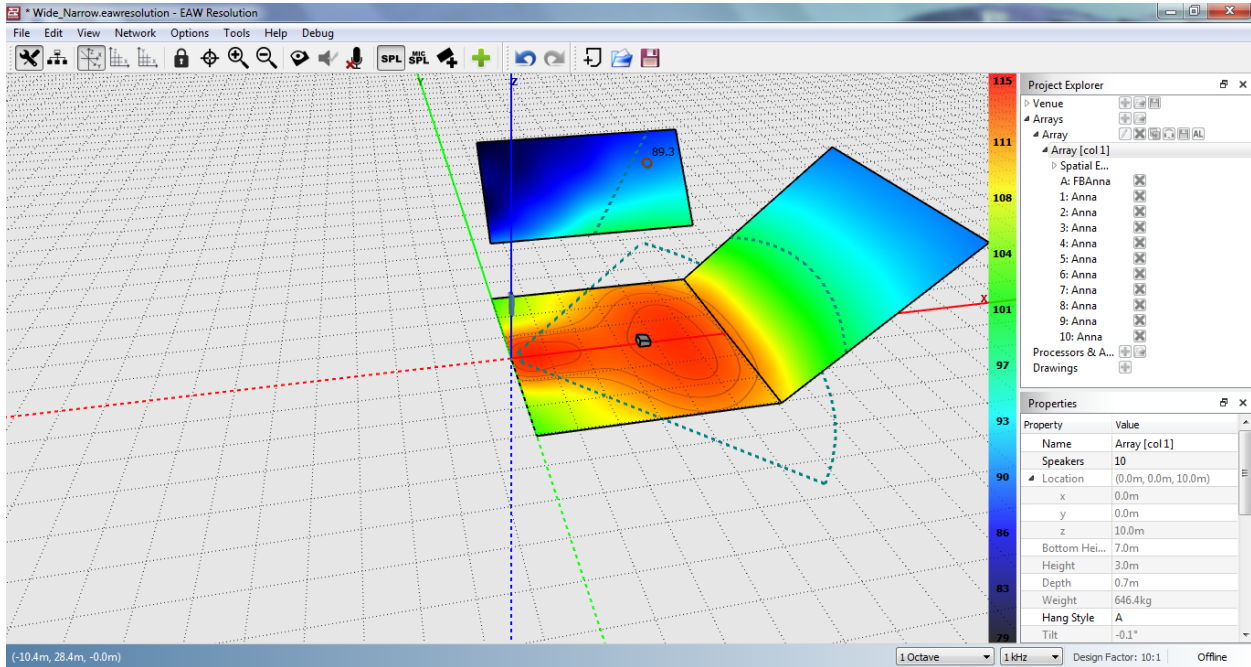

Coverage is contained on the floor section.

Show Sweep Lines & Show Venue Detection

There are new options under the View menu.

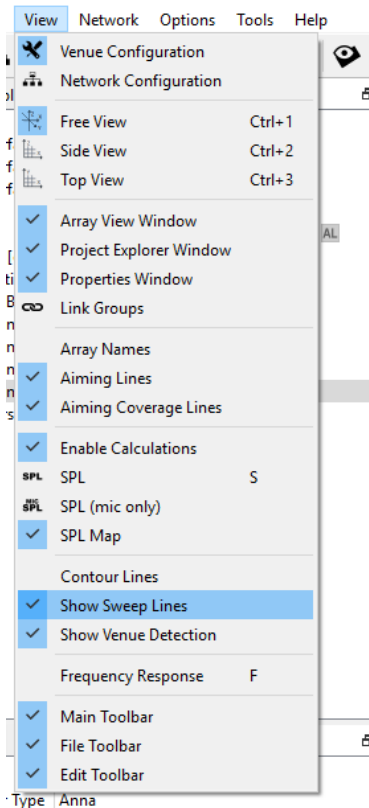

Show Venue Detection

Upon selecting to view this option, Resolution will display a pink line representing how the venue is being calculated.

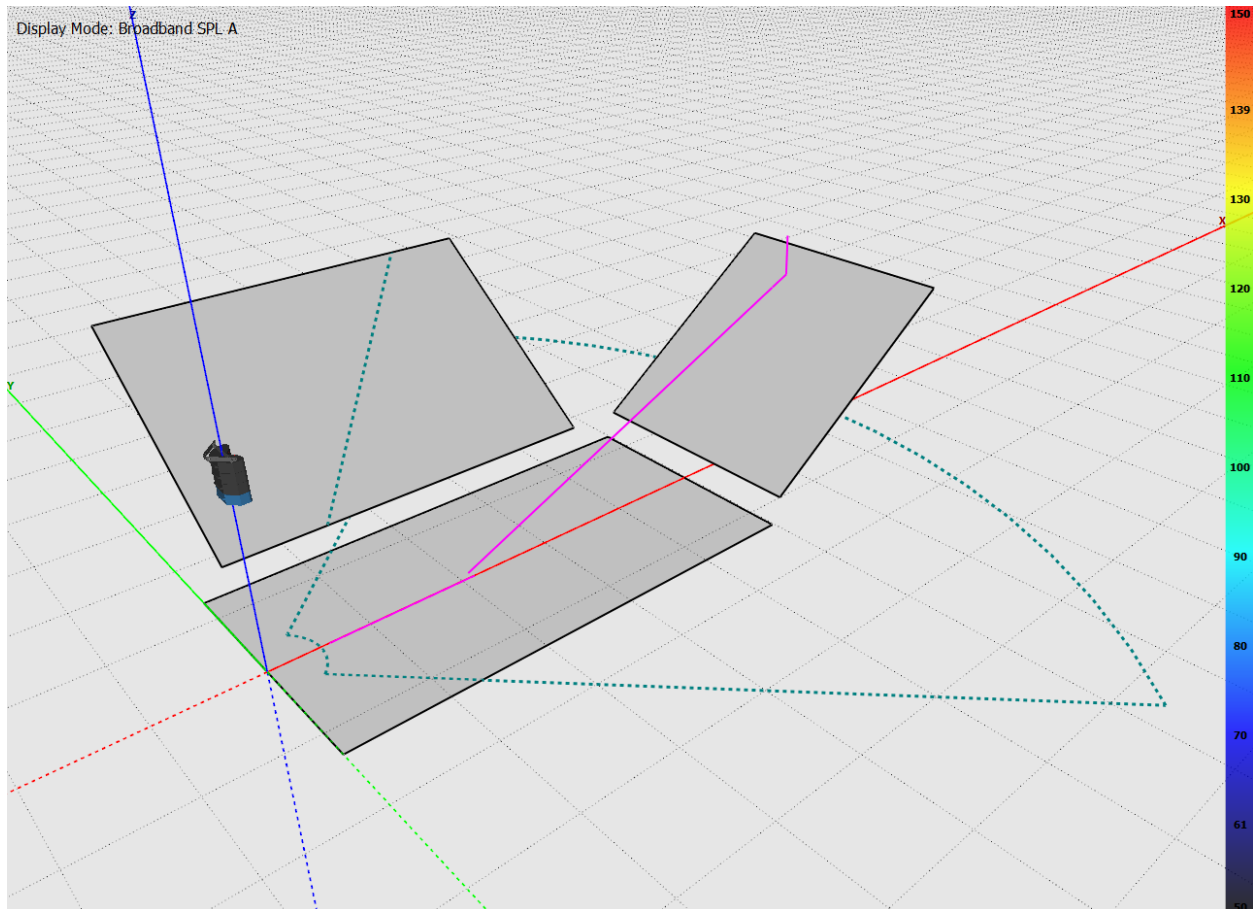

Show Sweep Lines

Upon selecting to view this option, Resolution will display a series of green lines showing which sections of each surface are being covered.

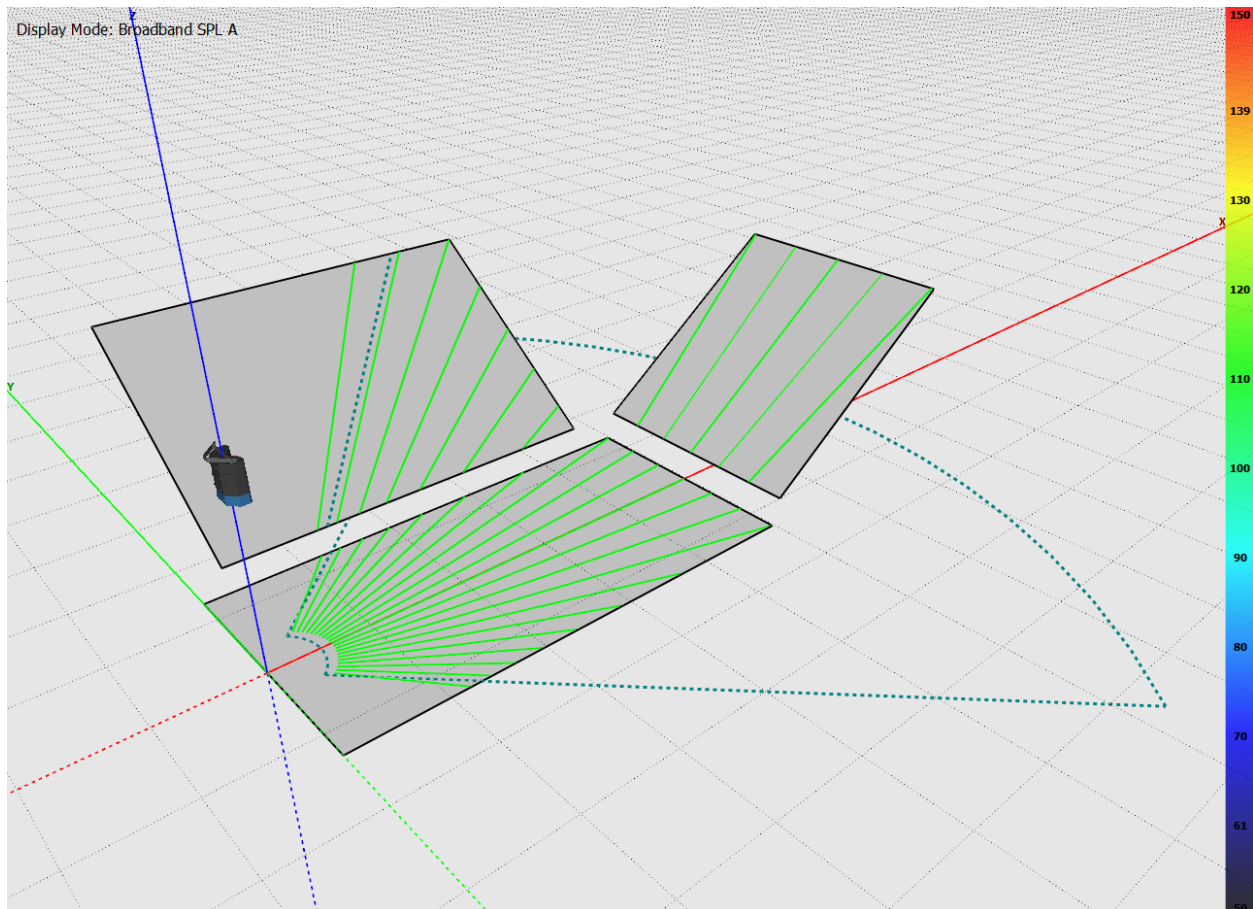



Improvements

Minor bug fixes relating to SPL recalculation engine.

- Remove coverage extension property for Otto
- SB818F shouldn't default to a rear Op Mode
- Extend Coverage has no effect when using the "Narrow" venue detection mode.
- Adjusting the SPL Range triggers an acoustic model calculation
- Reintroduce old coverage method as an option
- UX High Shelf, Low Shelf, Xmax, Vx Limiter are not reset when greyboxes are loaded
- Filter Settings differ from 2.6.1
- Base Delay for a Greybox leg is being set to the leg's Gain value
- Frequency Response window migrates down the screen each time it is opened
- Pulling settings from processor fails and can crash Resolution
- Regression: Processor Shelf/PEQ Filter Gain zeroed is not reflected in EQ View
- Complete KF810 / SB818 / FB / AB Data Files
- Filter "Type" is unexpectedly greyed out when adding/removing Greyboxes
- Wrong frequency is displayed for the HPF after a sub Greybox is loaded.
- Text on the second line of the Missing Greybox dialog is missing the output leg numbers
- UX network device name is not updated when "Pull" is selected.
- Characters that are entered on the output channel strips of processors/amps are erased when clicking OK button in the Select/Configure Greybox popup window
- Windows Stopped Working Error Appears When Attempting to Open .eawarray Files Via File > Open
- High / Low Shelf shape adjustments by mouse scroll not reflected in value field
- RSX212L RSX118F EASE GLL
- In Drawings Properties Pane for a Side View Imported Image Manually Entering a Z value of 10 Places Results in a 0 Value
- UX name in the online devices list isn't updated when the online device is assigned to an offline device with a different name
- Right clicking on a mute button in Network View toggles the mute and brings up the context menu
- Add Greybox Name somewhere in Greybox Section and Perhaps on mixer
- When creating a new Greybox the user should be prompted to assign an input if no input is selected
- UX amp or dsp mute button greyed out
- For HPF, and LPF should be able to enter a frequency beyond the allowable range to set filter to OUT

EAW Resolution v2.8.0.37 Release Notes

Previous Version: EAW Resolution v2.7.0.8

Resolution 2.8 contains several improvements for modeling and support for new products. For any questions, contact the Application Engineering team at design@eaw.com.

Key features in this release are listed below:

SPL Map/Adaptive Settings Saved with File

Acoustic SPL map and all steering settings are now saved with the Resolution file, allowing for quick display of SPL map upon loading a file, and quick upload of settings.

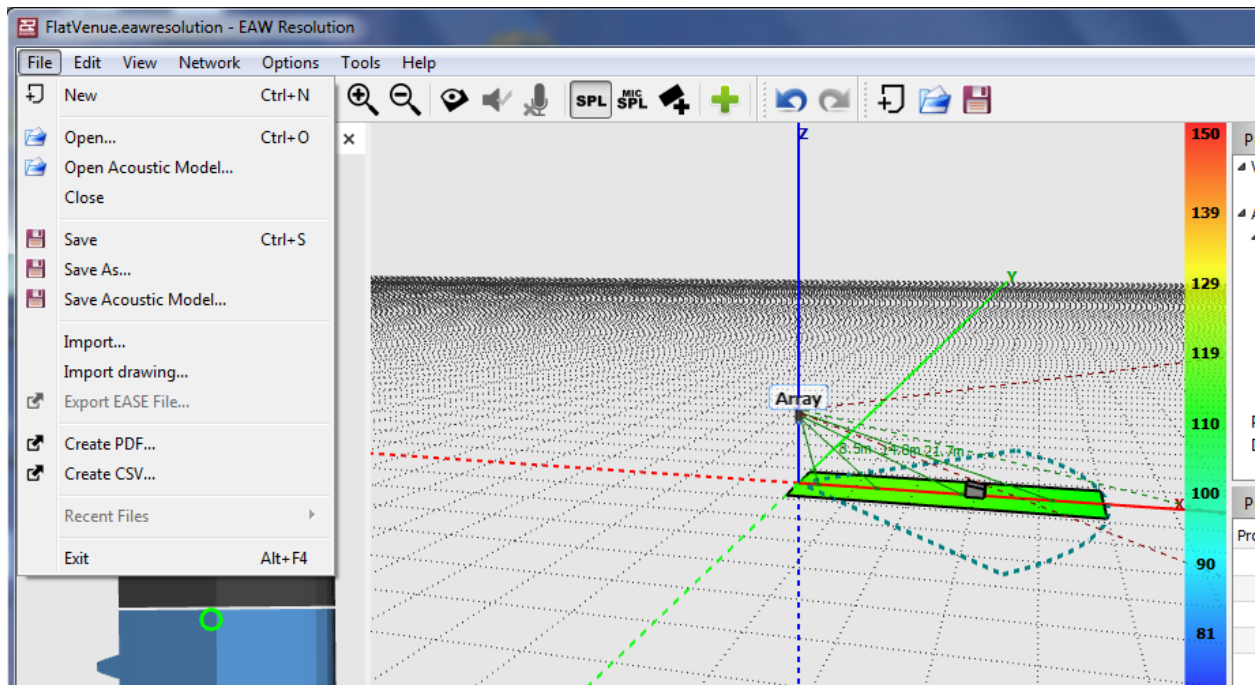

Fig 1. Save Acoustic Model option

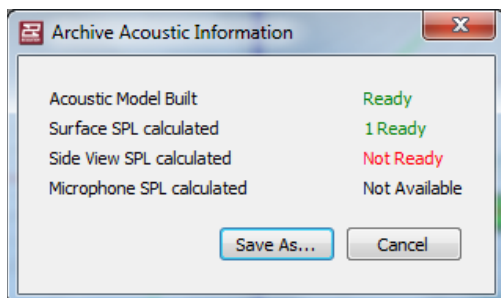

Fig 2. Acoustic Info: display of what's available to be saved

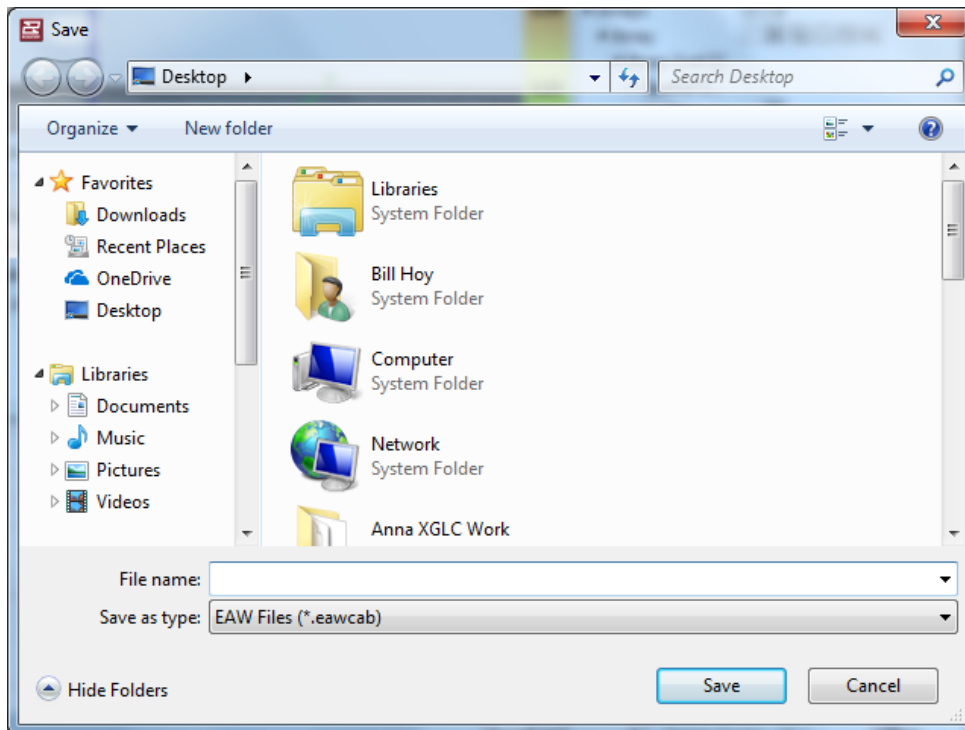

Fig 3. Save as *.eawcab

Improved Venue Detection/Surface Detection

Significant changes in adaptive algorithms and how venues/surfaces are analyzed. Improvements in both calculations and coverage for multi surface venues. Detection of the venue and any obscured audience sections are significantly better than before, resulting in better adaptation.

All examples below: SPL – Best, FLAT SPL, 1 octave 4k. Audience areas turned off for balconies.



UX/UXA Improvements

Small bug fixes. Improvement to GUI and communications.

Additional support for:

MKD864
MKD986
MKD826
MKD1064
MKD1096
MKD1026

SB825
SB828

RS121
RS151
RS115
RS123
RS153
RS118HP

EAW Resolution v2.7.0.8 Release Notes

Previous Version: EAW Resolution v2.6.1.111

Resolution 2.7.0 contains a number of improvements for UX processor and amplifiers and includes support for new EAW products. For any questions, contact the Application Engineering team at design@eaw.com.

Key features in this release are listed below:

KF810P-80, KF810P-100, and SB818P-F Support

Resolution 2.7.0 introduces support for the new KF810P-80, KF810P-110 loudspeakers and SB818P-F low frequency enclosure, providing total system optimization from anywhere in the venue, plus intuitive room design and prediction.

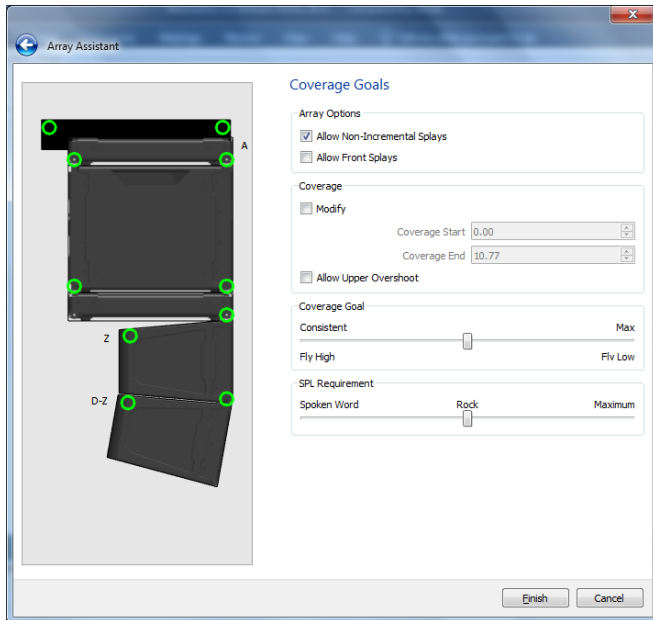
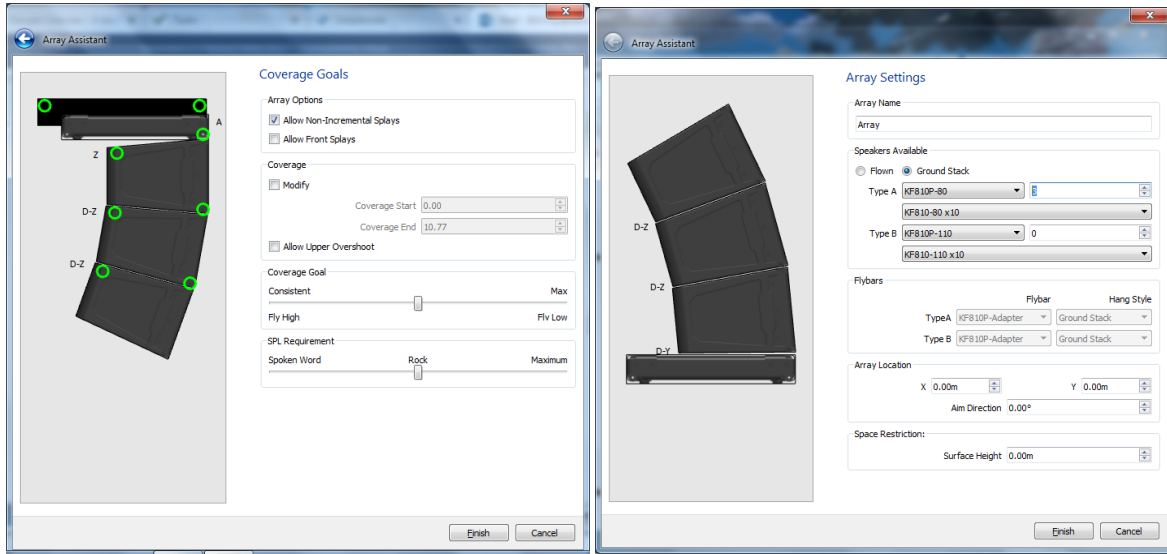

Additional Changes and Improvements:

Improvements and bug fixes to the UX Processor and Amplifier control and interfaces.

Note: This version may automatically restart after installation depending on your system configuration.

Known Issues:

When dragging an online UX device from the network to the workspace, temperature is set to 0° and humidity is set to 100%.



EAW Resolution v2.6.1 Release Notes

Previous Version: EAW Resolution v2.6.0.193

Resolution 2.6 contains a number of improvements for modeling and includes support for new EAW products. For any questions, contact the Application Engineering team at design@eaw.com.

Key features in this release are listed below:

RSX212L & RSX18F Support

Resolution 2.6 introduces support for the new RSX212L loudspeaker and RSX18F low frequency enclosure providing total system optimization from anywhere in the venue, plus intuitive room design and prediction.

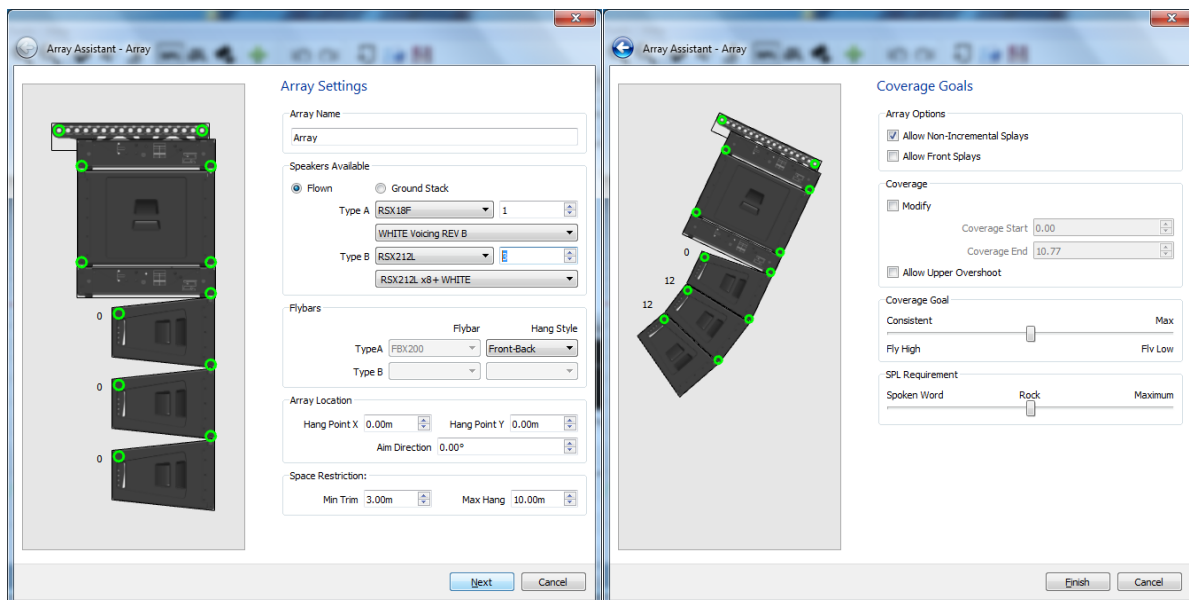
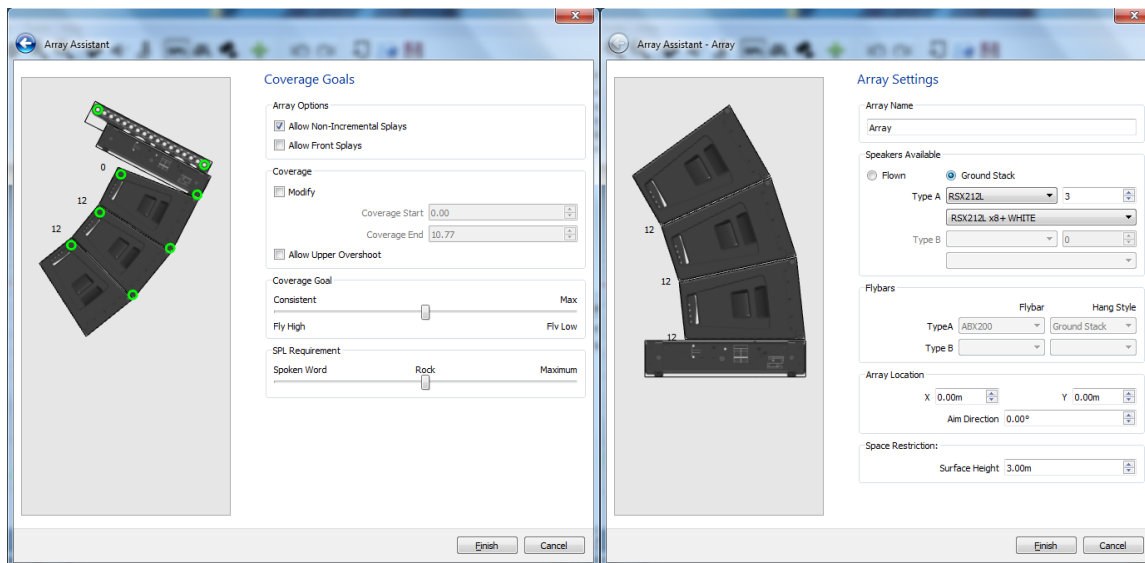

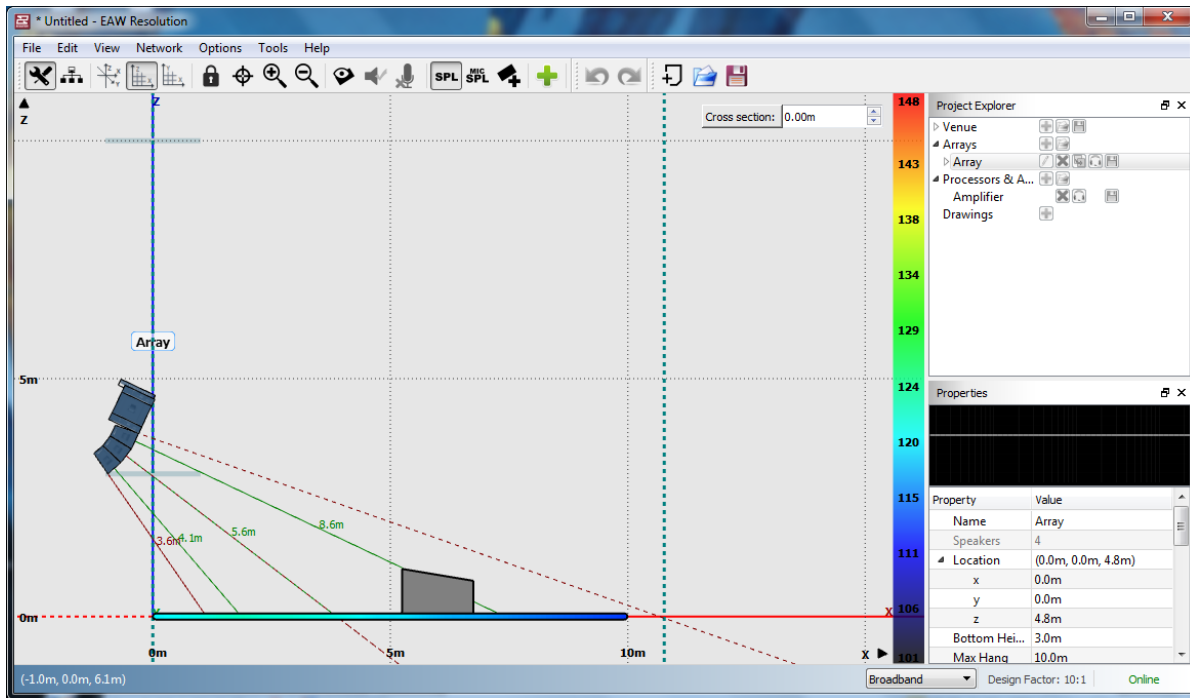

UX/UXA Processors and Amplifiers "Pull" feature

UX and UXA series processors and amplifiers state can now be read upon discovery.

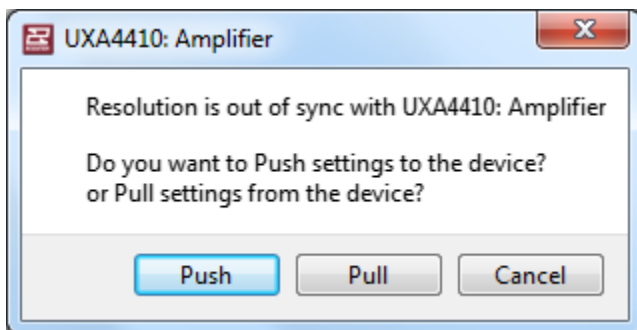

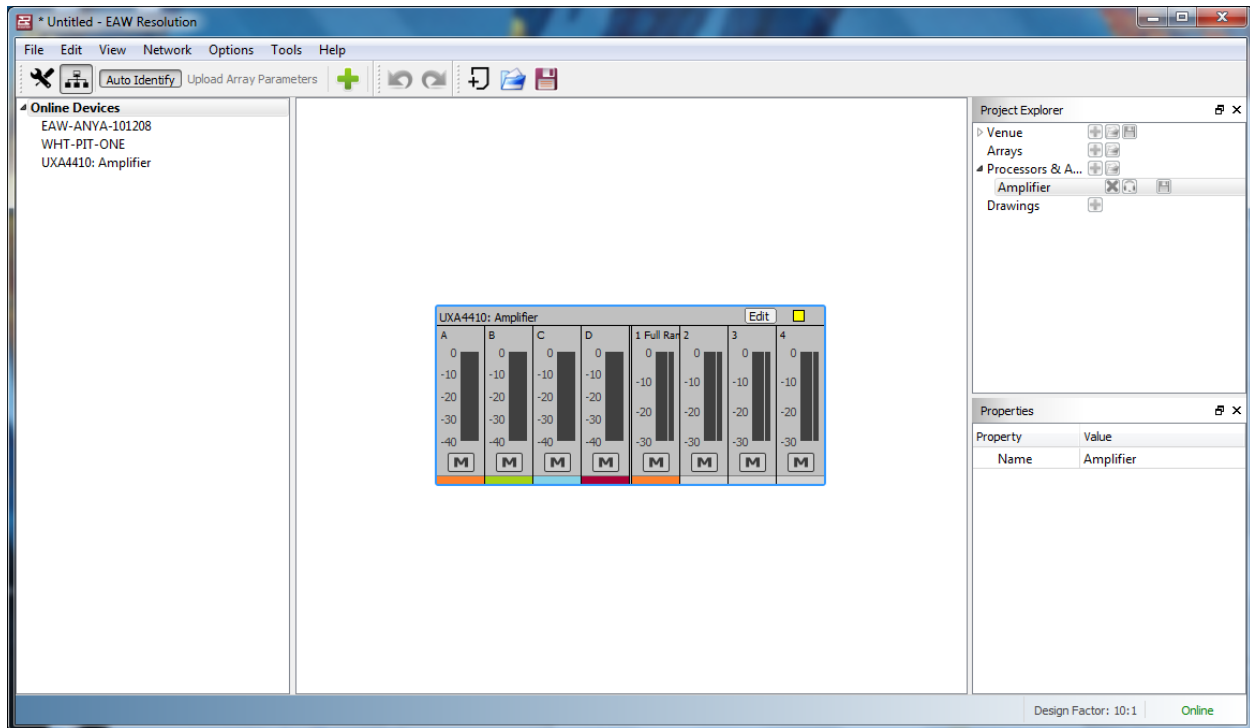

Note: UX and UXA devices and files used with Resolution 2.6.1 are not backwards compatible with 2.6 and prior versions of Resolution. Use of 2.6.1 files or devices with 2.6 will result in unexpected behavior.

Changes and Improvements:

Adaptive Products

- Adaptive aiming lines have been corrected.
- Improved communications between software and Adaptive DSP parameters.
- Coverage lines are no longer allowed to "shoot" thru venue surfaces.
- Resolution no longer crashes trying to open Preset Dialog



- Minor bug fixes to Anya Firmware. Anya Firmware is updated to v1.0.58.1, previous version was v.1.0.57.1.

UX Products

- Bridging is now handled properly, depending on the greybox legs loaded.
- Greybox dialog now displays the Rev #
- Greybox legs now limited to 8 max.
- Resolution will check UX FW and inform the user new FW is available
- Amp and Processor names are limited to 12 characters. If no processor name, model name is used.
- Processor name is now synchronized properly
- The user is notified when a Greybox definition cannot be found.
- Improved communications with all UX devices.
- Deleting UX device with any adaptive or non-adaptive speaker present no longer triggers acoustic model recalculation.
- UX/UXA meters now respond after the online device is unassigned and reassigned
- Limiter threshold returns to default when Greyboxes are unloaded

General

- Improved the interface for detailed 3D venues.
- Improved interface for HPF and LPF control
- Save no longer fails if the target directory or drive is missing
- Arrays below minimum trim are now properly indicated
- SPL C menu item added
- Improved the display of Audinate error codes
- Network view meters now cleared when Resolution goes offline
- Re-running the array wizard now presents the user with an option to leave the Air Loss unchanged



EAW Resolution v2.6.0.193 Release Notes

Previous Version: EAW Resolution v2.5.0.78

Resolution 2.6 contains a number of improvements for modeling, and includes support for new EAW products. For any questions, contact the Application Engineering team at design@eaw.com.

Key features in this release are listed below:

UX/UXA Processors & Amplifiers

Resolution 2.6 introduces support for the new EAW UX series which includes the UX48 System Processor and EAW UXA4406, UXA4410 and UXA4810 Amplifiers. This provides the user with complete control and monitoring of key processor and amplifier controls and ensures the best possible performance of an EAW sound reinforcement system through seamless integration of EAW's Greybox technology. Together, EAW Resolution and UX series allow setup and operation in a fraction of the time required with other amplification systems.

Click the "+" symbol next to Processors & Amplifiers under the Project explorer window to add to the system:

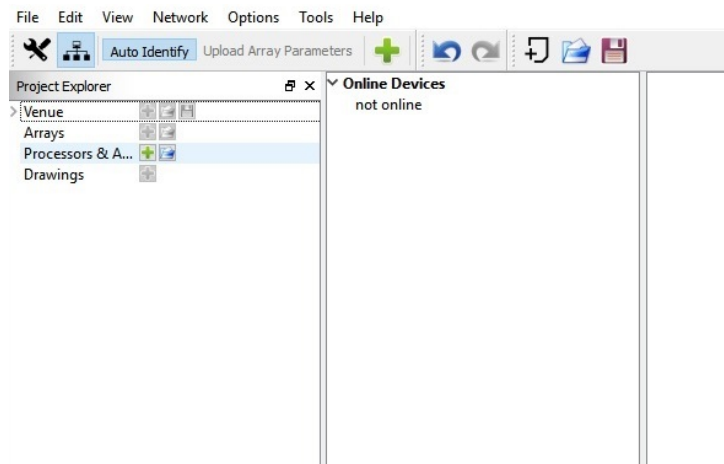

A dialog will appear allowing users to name and select the exact product being used:

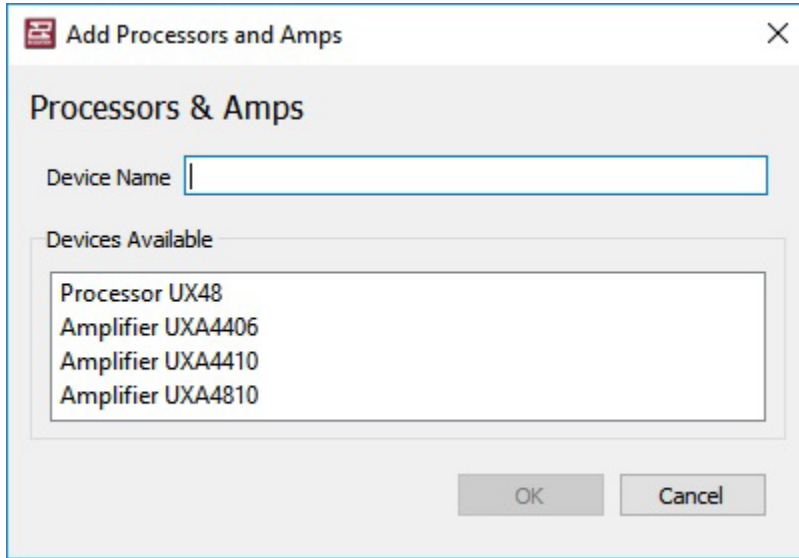

Once a processor or amplifier has been added to the system, the user will be provided with the option to add Greyboxes and edit DSP parameters:

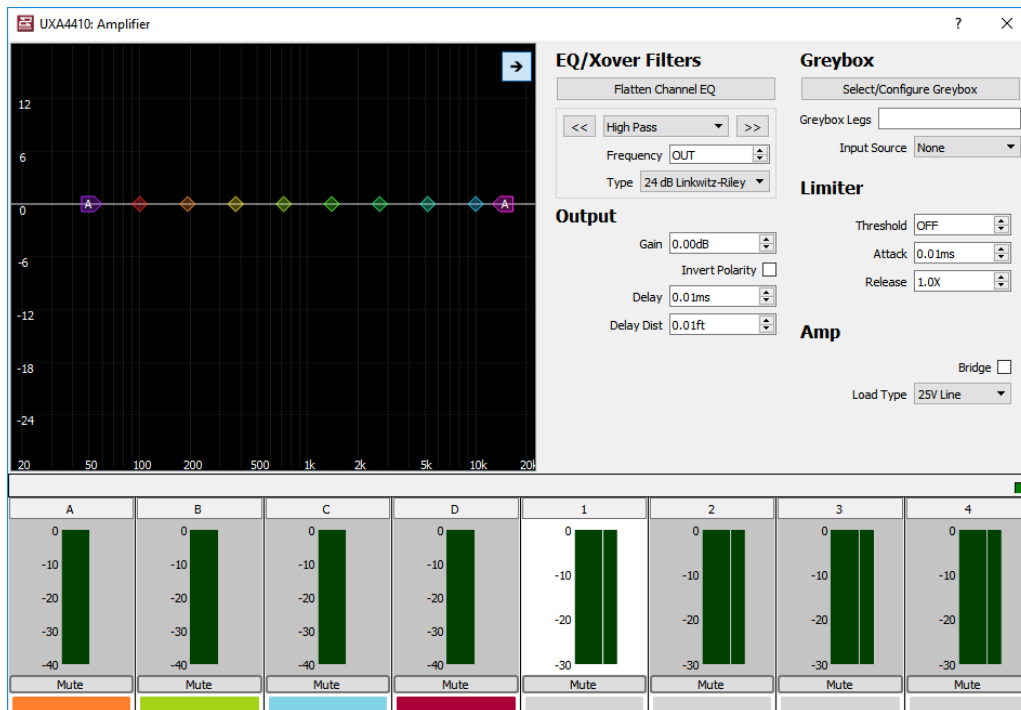

ANYA V2 Amp Module



This will be seamless to the user allowing for mixed arrays of v1 and v2 ANYA amp modules (assuming all voicings are correctly loaded).

Other Changes and Improvements:

- Resolved an issue where Resolution could crash when creating a New System using the keyboard shortcut.
- Network>Configure... has been renamed to Network>Configure Dante...
- Resolved an issue where Firmware Updates sometimes reported success when they had failed.
- Resolved an issue where the Parameter Sync dialog could show duplicate entries.
- Resolved an issue where the Array meters in Network View continued to show the last level after the network had been disconnected.

Known Issues:

- EASE export may fail for larger Anya arrays.
 - Workaround: Contact EAW Application Support for assistance in exporting EASE balloons for large arrays.
- Reading logs from Adaptive systems can sometimes take a long time or fail.
 - Workaround: Retry log request.
- The Array Assistant will sometimes indicate that the array is 'not aimed at a surface' for venues built in the -X direction because arrays default to aiming in the +X direction.
 - Workaround: Adjust panning so that array is aimed in -X direction (180 degrees). This can be done in the second page of the Array Assistant.
- The PC may need to restart upon completion of the Resolution installation due to the updates to Dante Services if they are outdated.
 - Workaround: None. Allow computer to restart. Do not install new versions of Resolution in situations when it is critical that the computer not be restarted. If other programs are running, Windows will prompt the user to save their work before closing.
- Resolution may warn that an array is 'below minimum trim' when it is actually not, based on the value set in the 'Properties' pane.
 - Workaround: Re-run Array Assistant with modified Min Trim value. Warning should disappear.

EAW Resolution v2.5.0.78 Release Notes

Previous Version: EAW Resolution v2.4.0.87



Resolution 2.5 contains a number of improvements for modeling of all EAW products and control of Adaptive systems. For any questions, contact the Application Engineering team at design@eaw.com.

Key features in this release are listed below:

External Image Import

Users can now import external graphical images as plan and sections views in order to aid the rapid building of Resolution models from architectural drawings. BMP, JPG, PNG and GIF file formats are currently supported. To add an image, locate "Import Drawing" under the "File" menu, or the "Drawings" item in the Project Explorer pane and click the "+" button to begin the import process:

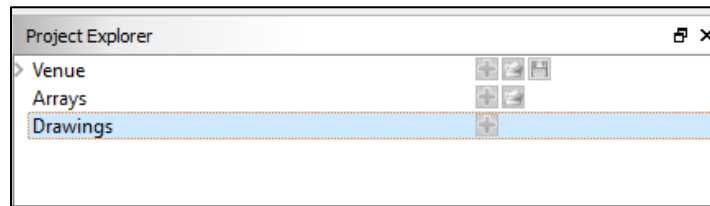

A dialog will appear allowing users to scale and locate the drawing within the 3D Resolution model in both plan (XY planes) and section (XZ and YZ planes) views. After importing an image, users can simply overlay venue surfaces to the model as they normally would. This feature allows users to quickly generate 3D Resolution models based on architectural drawings, as shown below:

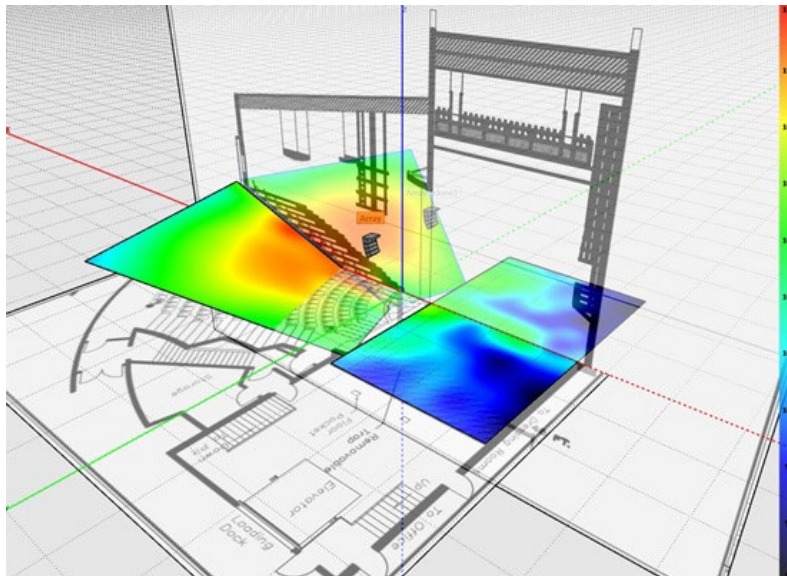

Adaptive Health Display

For Adaptive Systems users, the health of the current online system can now be easily viewed in a single location via this new feature. Though fault detection and Adaptive Healing are not new features, this display increases the ease of use for system technicians and engineers in show environments by assembling all available information in one place and providing guidance on when it is necessary to act on issues and when they are unlikely to have any noticeable impact on system performance.



While online and assigned, Resolution will continually monitor the status of all modules in the system. The status of the system is visible in the lower-right hand corner of the main window.

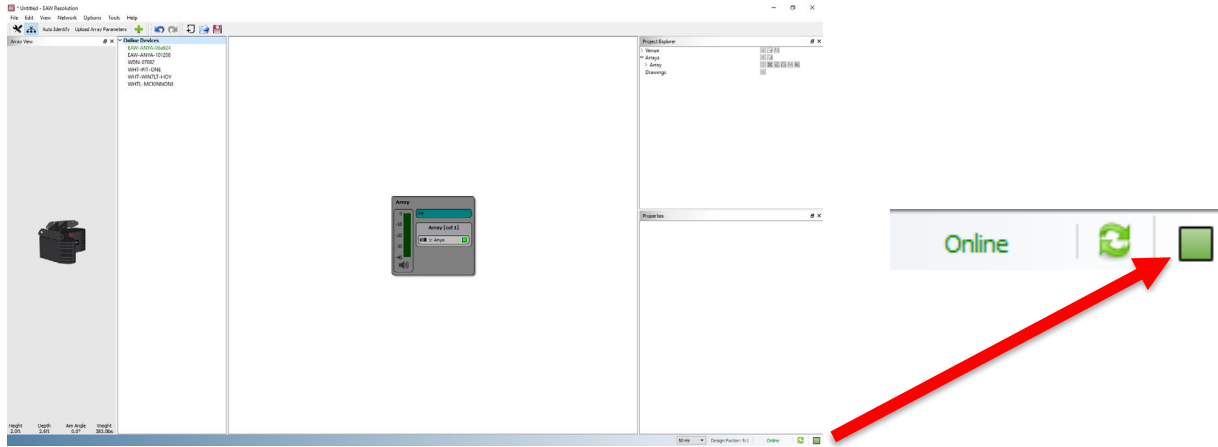

The display can have one of three states, each of which is shown below:

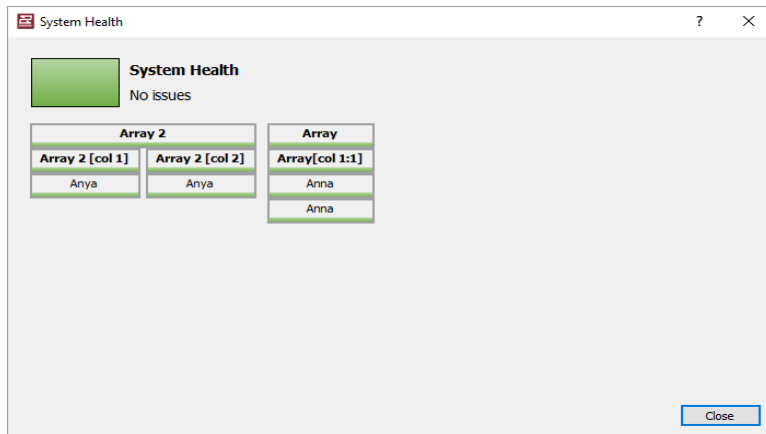

Green: No issues. System health is at 100%.

(Continued on next page)

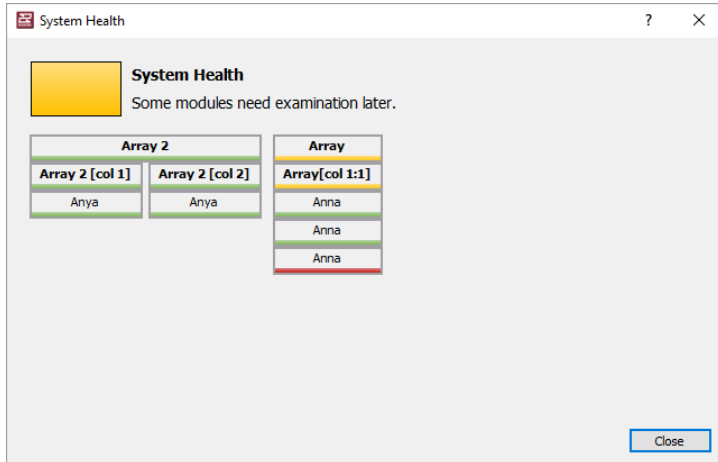

Yellow: Errors or faults detected, but acoustical impact is less than 1 dB. No immediate user action needed.

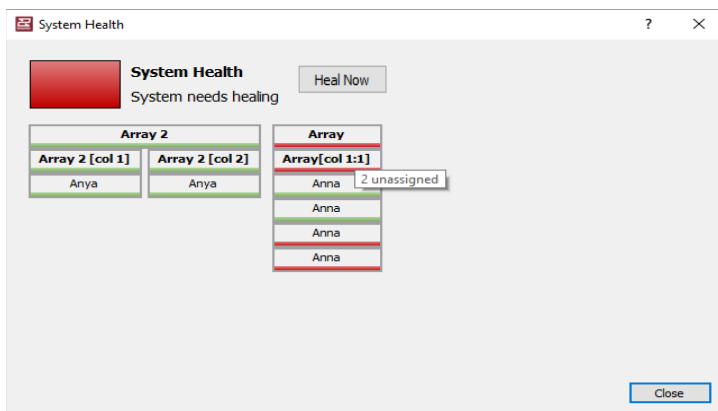

Red: Errors or faults detected and impact is more than 1 dB. Immediate user action is recommended.

Once the user has healed the system and uploaded array parameters, the state returns to green, but with an indication that healing has been performed (denoted by an "H"):

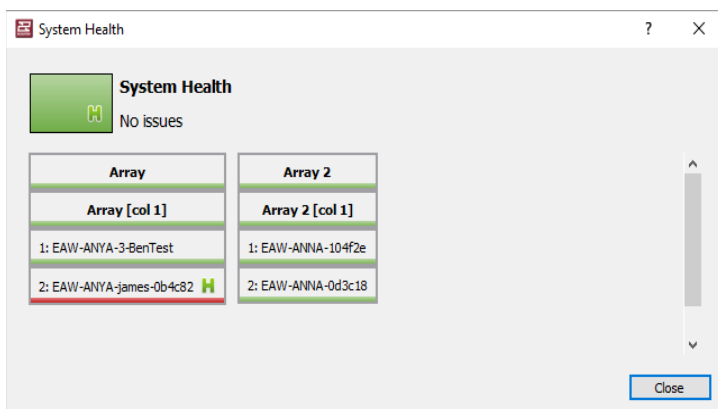

If additional faults or errors occur, the progression of yellow (less than 1 dB acoustical impact) to red (1 dB or greater acoustical impact) will begin again with the 'Healed' state as the new baseline.



Other Changes and Improvements:

- Max SPL now includes effects of user EQ (both Array and Spatial).
- Added a function to check whether a Dante transmitter has gone offline before uploading parameters with a Dante input assignment. User will be alerted if an array's assigned input transmitter is no longer present on the network and the user attempts to upload array parameters.
- Includes updated Anna data file (1.1.14), improving MF/HF phase linearity and modeled consistency.
- Fixed an issue where Otto would not properly apply rejection perpendicular to array physical aim direction in some circumstances.
- Fixed an issue where the tab order in the Air Loss Compensation window skipped fields.
- Fixed an issue where the Input Assignment dialog would create multicast flows when user had not requested them.
- Fixed an issue where vertical surfaces could cause unexpected directivity with Adaptive systems.
- Fixed an issue where some overlapping surfaces could cause incorrect SPL predictions with Adaptive systems.
- RSX208L voicing now defaults to x6-8 (white), resulting in more accurate SPL predictions with a majority of user configurations.

Known Issues:

- EASE export may fail for larger Anya arrays.
 - Workaround: Contact EAW Application Support for assistance in exporting EASE balloons for large arrays.
- Reading logs from Adaptive systems can sometimes take a long time or fail.
 - Workaround: Retry log request.
- The Array Assistant will sometimes indicate that the array is 'not aimed at a surface' for venues built in the -X direction because arrays default to aiming in the +X direction.
 - Workaround: Adjust panning so that array is aimed in -X direction (180 degrees). This can be done in the second page of the Array Assistant.
- The PC may need to restart upon completion of the Resolution installation due to the updates to Dante Services if they are outdated.
 - Workaround: None. Allow computer to restart. Do not install new versions of Resolution in situations when it is critical that the computer not be restarted. If other programs are running, Windows will prompt the user to save their work before closing.



- Resolution may warn that an array is 'below minimum trim' when it is actually not, based on the value set in the 'Properties' pane.
 - Workaround: Re-run Array Assistant with modified Min Trim value. Warning should disappear.

EAW Resolution v2.4.0.87 Release Notes

Previous Version: EAW Resolution v2.3.0.123

Resolution 2.4 contains a number of usability improvements and bug fixes, greatly improving user workflow in model building. For any questions, contact the Application Engineering team at design@eaw.com.

NOTE: Resolution 2.4 includes updated firmware for Anna. Updating to this version of firmware is strongly recommended.

Key features in this release are listed below:

Multi-Select for Surfaces and Arrays

Users can now manipulate properties such as Solo, Lock, Audience/Non Audience, Ear Height and Hidden on as well as mass deletion on multiple surfaces or loudspeakers simultaneously. This saves significant time when editing models. To use multi-select, hold CTRL while selecting individual surfaces or arrays, or SHIFT to select a range of surfaces or arrays. Users can also access multi-select functions from the right-click menu.

Massive Speed Improvements

Resolution is now significantly faster due to better utilization of multi-core CPUs, achieving speed increases of up to 300% over previous versions. This includes both acoustical model and SPL calculations.

Adaptive Coverage Start/Stop Z-Override

Adaptive array coverage can now be limited vertically, employing the same 'z-override' feature as in Spatial EQ. This can be useful in venues with balconies that overlap the main floor. In the following example, the Z values exclude the balcony such that the array only covers the main floor:

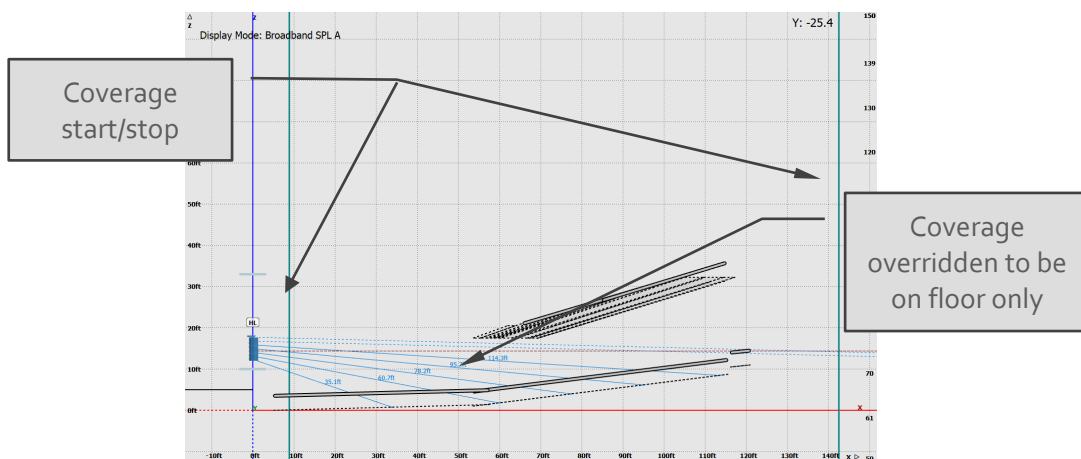



Other Changes and Improvements:

- RSX208L voicing now defaults to x6-8 (white), resulting in more accurate SPL predictions with a majority of user configurations.
- Fixed an issue where Dante Services would require a restart after being installed but did not inform the user, resulting in an error until the computer was restarted.
- Fixed an issue where Resolution would sometimes take long periods of time to change Adaptive coverage in very large venue and system models.
- Fixed an issue where the 3D rotation function in Free View would not work if the model had vertical (90-degree) surfaces.
- Improved Anna near-field coverage consistency in situations where audience areas are at extreme down-angles relative to array.
- The Parameter Sync feature now includes even more robust error checking.
- The Help File has been significantly updated to include new features.
- Includes updated firmware
 - Anna -- 1.0.19.0. Improves long-term reliability in situations where the system is power cycled very frequently.

Known Issues:

- EASE export may fail for larger Anya arrays.
 - Workaround: Contact EAW Application Support for assistance in exporting EASE balloons for large arrays.
- Reading logs from Adaptive systems can sometimes take a long time or fail.
 - Workaround: Retry log request.
- The Array Assistant will sometimes indicate that the array is 'not aimed at a surface' for venues built in the -X direction because arrays default to aiming in the +X direction.
 - Workaround: Adjust panning so that array is aimed in -X direction (180 degrees). This can be done in the second page of the Array Assistant.
- The PC may need to restart upon completion of the Resolution installation due to the updates to Dante Services.
 - Workaround: None. Allow computer to restart. Do not install new versions of Resolution in situations when it is critical that the computer not be restarted. If other programs are running, Windows will prompt the user to save their work before closing.



EAW Resolution v2.3.0.123 Release Notes

Previous Version: EAW Resolution v2.1.4.98

Resolution 2.3 contains many significant improvements and bug fixes, greatly improving the user experience. For any questions, contact the Applications team at design@eaw.com. *Note that a firmware update is required for Anna and Anya to access key Resolution 2.3 features.*

Key features in this release are listed below:



Resolution 2.3 introduces Spatial Equalization for Adaptive Systems, a new and unique technology that allows users to equalize parts of the coverage by simply selecting the audience areas in which the change is desired and applying the desired equalization. The Adaptive system then determines the processing necessary to achieve the goal and implements it, in real time. This saves massive time and effort when on-site setting up a system and produces superior results compared to any conventional line array system. **For the first time, users can truly EQ the room instead of the sound system.**

For more detail on this feature, please see the Spatial Equalization Technical Paper and the Spatial Equalization Overview video.

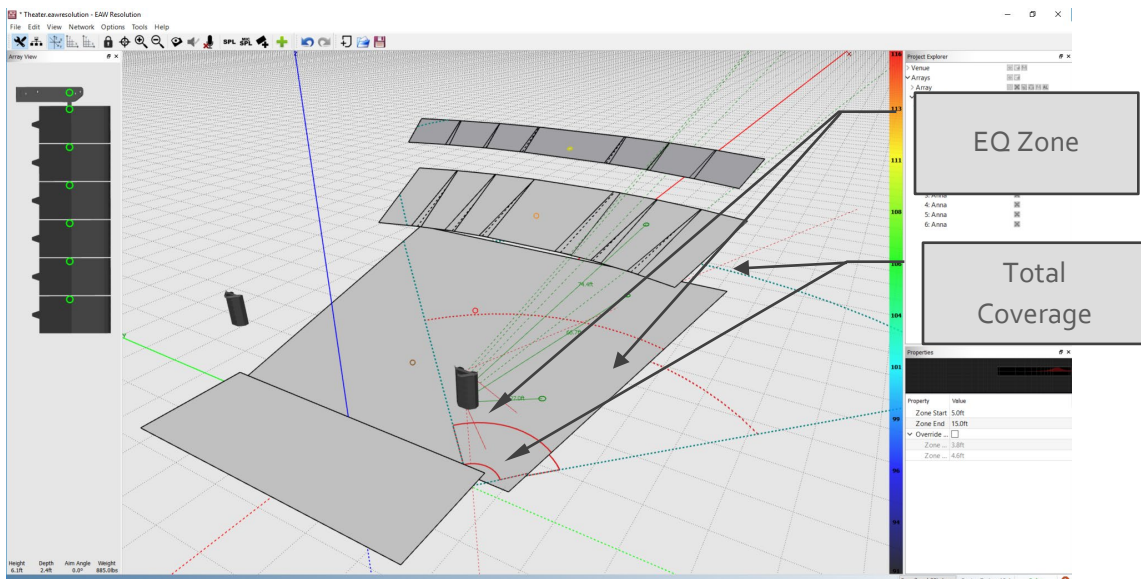

Improved Air Loss Compensation

This version of Resolution provides a new Air Loss Compensation algorithm for Adaptive systems, generating significantly greater high-frequency throw while also improving HF consistency throughout



the entire venue. Additionally, this feature allows users to optimize the HF response of their system for different situations, trading between headroom, throw and extension, providing up to 12 dB of additional HF energy at distances of 300 feet or more from the array.

Adaptive users can access this feature by clicking on the “AL” button at the array level under the Project Explorer. In this control panel, users have a number of new controls:

- **Headroom Penalty** – Indicates the reduction in high-frequency headroom expected with the current user parameters (Note: User must hit ‘Apply’ for these to be applied to the acoustical model).
- **Target Reference** – Indicates the distance reference for the high-frequency tonality the user desires for the entire coverage area. In other words, the high-frequency roll-off characteristic for *this distance* will be used as a target for the rest of the coverage area. This can be set by dragging the point on the graph, or by entering numerical values into the dialog box. Closer distances will result in more extended high-frequency response at the expense of headroom, while greater distances will reduce high-frequency extension but will increase headroom.
- **Rear Threshold** – Indicates the distance limit to which the user wishes to maintain the target high-frequency tonality. This can be set by dragging the point on the graph, or by entering numerical values into the dialog box. Closer distances will result in greater high-frequency roll-off at the rear of the coverage but will improve headroom, while the greater distances will reduce high-frequency roll-off at the rear of the audience at the expense of headroom.
- **Enhancement Level** – An overall level adjustment for the amount of air loss compensation being applied to the system. Increasing this will improve high-frequency throw at the expense of headroom.
- **Presets** – Provides a number of pre-defined starting points for user setup convenience. These are also provided in the Array Assistant.

The control panel itself can be seen on the following page.

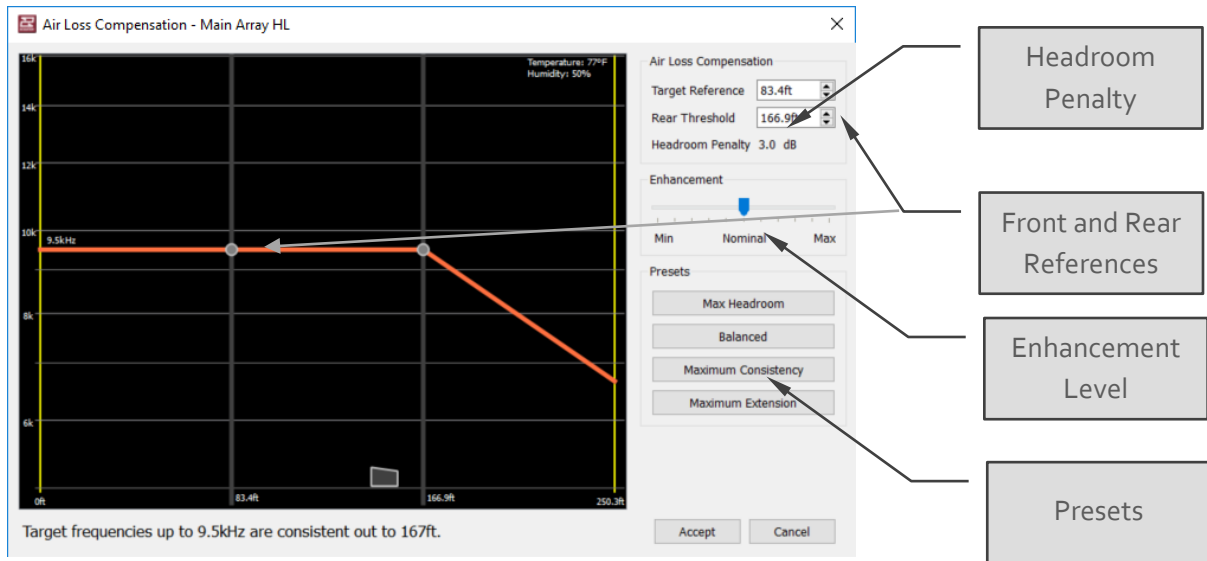

A typical array's high-frequency response in earlier versions of Resolution:

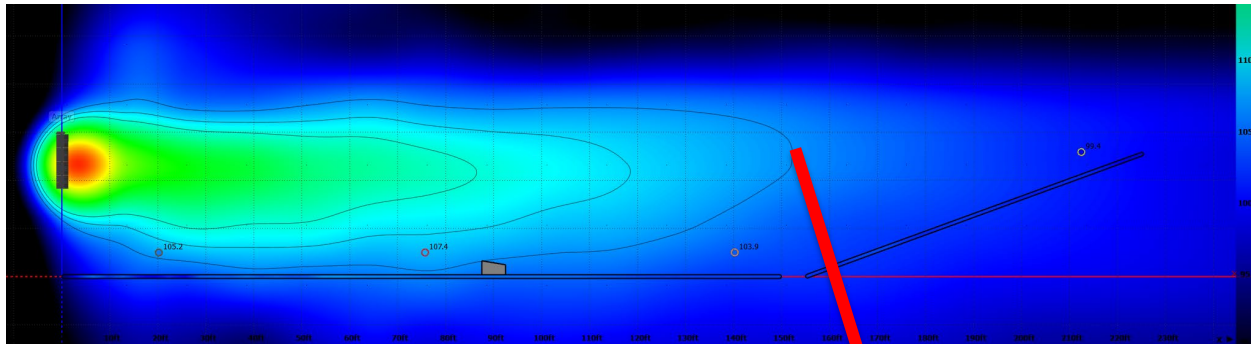

A typical array's high-frequency response in this version of Resolution. This system extends high-frequency throw, as can be seen by the extension of the coverage contour lines much further back in the venue.

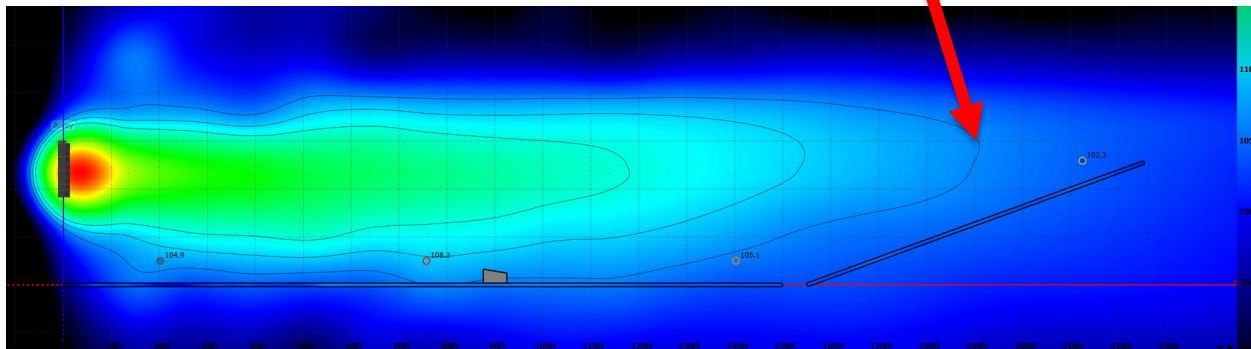

Preset Recall



This version of Resolution allows Adaptive users to easily store and recall system states via Resolution for quick access. With this feature, radically different coverage and voicing settings can be recalled within seconds with only a few mouse clicks, enabling users of all skill levels to leverage the enormous power of Adaptive Systems.

As an example, Preset Recall could be used with a permanently-installed system to accommodate different venue uses – the main floor only, the main floor + the balcony, and only a section of the main floor, as examples – depending on attendance for a particular event. This ensures that the sound system is directing energy only where there are audience members, minimizing reverberation and enhancing clarity.

The Preset Manager window (accessible via the Network Menu when online) is shown below:

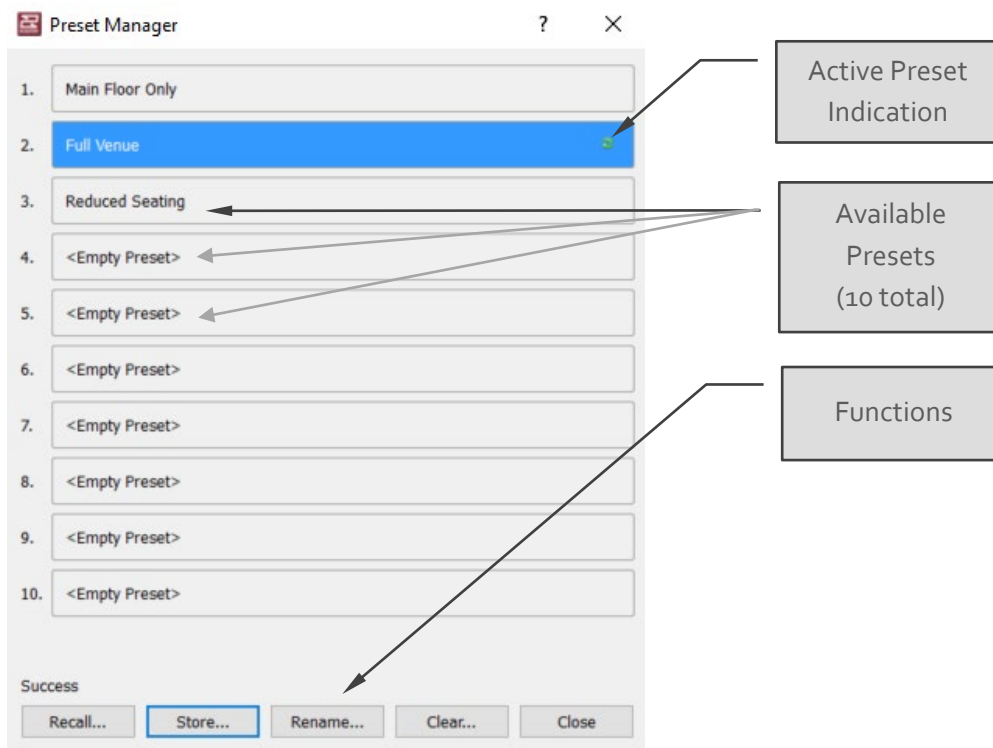



Other Changes and Improvements:

- Added feedback to the user if the Adaptive array input Dante subscription fails for any reason (i.e. more than 32 receivers are attempting to subscribe to a device via a unicast flow).
- Adaptive array temperature faults now prompt the user with the option to perform Adaptive Healing on the array.
- Adaptive coverage lines are now visible on elevated surfaces.
- Number of modules that can be added to an array is now limited to 50 (formerly had no limit, so users could accidentally type very high numbers).
- Fixed issue where LED settings for Adaptive modules could revert to 'Off' without the user's input after an Array Parameter upload in some cases.
- Fixed issue where Resolution could crash when re-running the Array Assist with a ground-stacked RADIUS system with RSP-1 and RSP-2 pole mounts.
- Fixed issue where left and right Adaptive arrays could sometimes have very small differences in coverage due to slight venue asymmetries.
- Fixed issue where CSV export added unexpected characters.
- Fixed issue where side view mouse z-value was wrong when hovering over a surface with an ear height other than zero.
- Fixed an issue where Array View text could be cut off when running Resolution on Windows 10.
- Fixed an issue where the Project Explorer would not show modules in manually-added columns for Adaptive arrays.
- Fixed issue where Design Factor dialog text could be cut off on Windows 10.
- Fixed issue where Resolution could temporarily hang when the acoustical model calculation reaches 100%.
- Fixed issue where locked virtual microphones could still be edited.
- Fixed issue where right-clicking above the horizon in Free View and adding a virtual microphone or surface could add that object behind the user's perspective.
- Includes updated firmware (update is required to use new Resolution 2.3 features):
 - Anya – 1.0.44.1
 - Anna – 1.0.18.0
- Updated firmware for Anya also improves fan logic for reduced noise in quiet environments.



Known Issues:

- EASE export may fail for larger Anya arrays.
 - Workaround: Contact EAW Application Support for assistance in exporting EASE balloons for large arrays.
 - Reading logs from Adaptive systems can sometimes take a long time or fail.
 - Workaround: Retry log request.
 - The Array Assistant will sometimes indicate that the array is 'not aimed at a surface' for venues built in the -X direction.
 - Workaround: Click 'OK', ensure that coverage start and finish are correct, and finish the Array Assistant. The array will be inserted and the acoustic model will still calculate normally.
 - When installing Resolution, Dante Services requires a restart to function but does not alert the user.
 - Workaround: Restart the computer after installation before using Resolution.
-



EAW Resolution v2.1.4.98 Release Notes

Previous Version: EAW Resolution v2.1.3.84

Resolution 2.1.4.98 contains many significant improvements and bug fixes, greatly improving the user experience. For any questions, contact the Applications team at design@eaw.com. Key features in this release are listed below:

Improved Metering for Adaptive Products

The module metering for Anya, Anna and Otto has undergone a significant redesign to provide more precise, clearer information. Now, users can determine available headroom before the onset of limiting with just a quick glance. Limit thresholds are now indicated by yellow bars on the left side of each channel, with gain reduction (when active) on the right side of each channel as shown below.

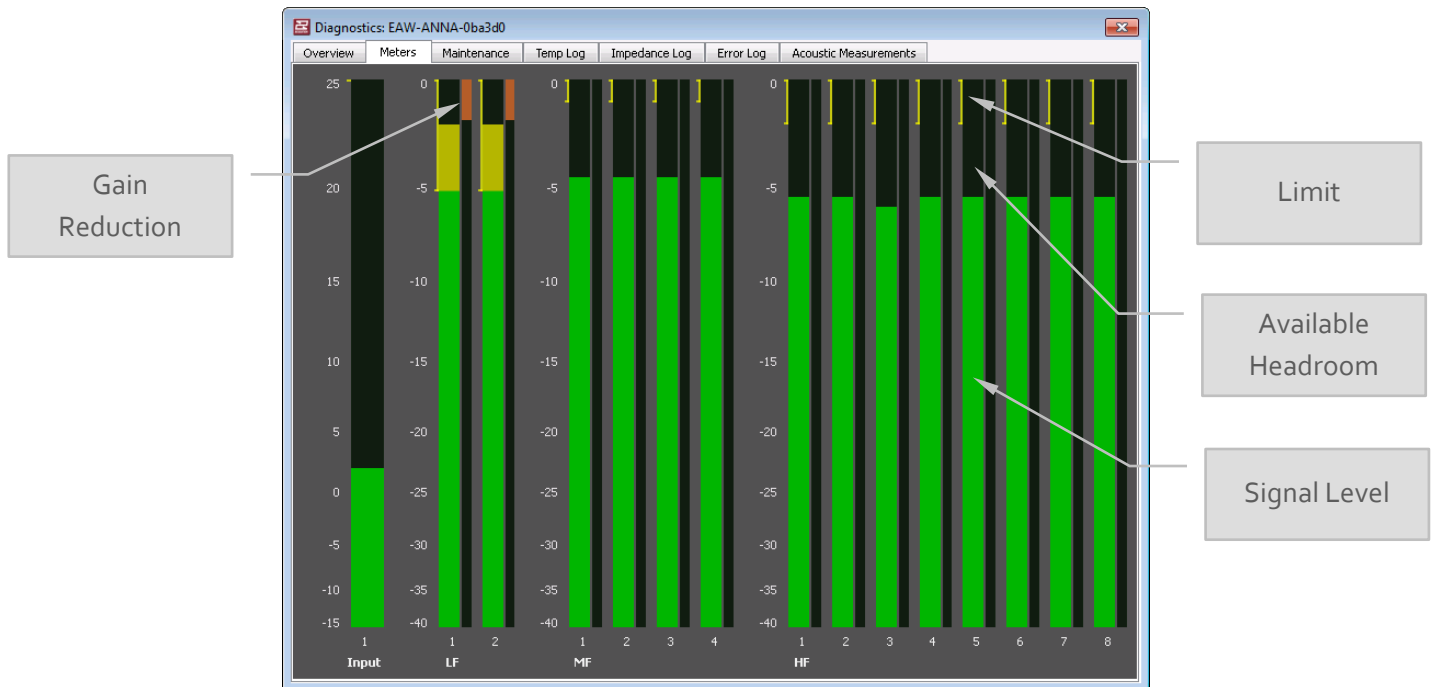

The update speed for the metering display has also been increased by approximately 5x on Anna, providing much more responsive feedback to the user. This change will be implemented in Anya and Otto in early 2017 as well but will require a firmware update.

Additionally, the input meter scale now changes depending on the type of input selected. When "Analog" is selected, the input meter units are scaled in dBu, corresponding to input voltage. When AES or Dante is selected, the input meter is scaled in dBFs.

Non-Audience Surfaces

Users can now add surfaces to a Resolution design for visual reference and SPL mapping, but exclude them from coverage via the "Audience" checkbox in each surface's Properties pane. This enables users to now enter and display architectural surfaces in a venue (such as ceilings and walls) that are useful for visual reference and/or to see SPL mapping, but that should not be covered by the sound system.



When “Audience” is unchecked, SPL will still plot on surfaces. The “Hidden” option will prevent SPL from plotting on surfaces, but they will still be covered by the sound system unless “Audience” is also unchecked.

NOTE: Non-audience surfaces are not included in Resolution’s verification of shadowing by surfaces. In other words, if a surface is not indicated as “Audience”, Adaptive algorithms will completely ignore it, which may result in aiming lines intersecting non-audience surfaces while actually covering the audience surfaces behind it.

Property	Value
Name	new surface
▲ Start	(0.0ft, 0.0ft, 0.0ft)
x	0.0ft
y	0.0ft
z	0.0ft
Length	100.0ft
Inclination ...	3.0°
Width	26.2ft
Width Rear	26.2ft
Rotation An...	0.0°
Audience	<input checked="" type="checkbox"/>
▲ Ear Height	0.0ft
Floor	<input checked="" type="checkbox"/>
Seated	<input type="checkbox"/>
Standing	<input type="checkbox"/>
Hidden	<input type="checkbox"/>
Locked	<input type="checkbox"/>

By default, newly-inserted surfaces have the ‘Audience’ parameter enabled.

Improved Surface Isolation for Adaptive Systems

This version of Resolution significantly improves Anya and Anna's ability to avoid areas between surfaces, both increasing the isolation of the audience surfaces from a building's architecture and further improving SPL and consistency. With this improvement, SPL is reduced between audience surfaces by as much as 10-15 dB (the reduction will vary by audience geometry and array configuration).

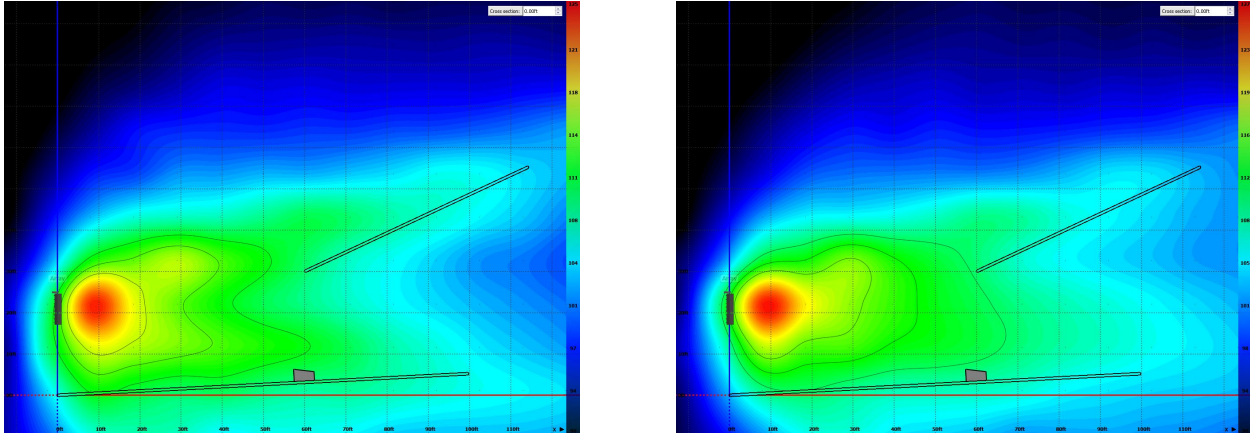

NOTE: It is **not necessary** to define non-audience areas to achieve this effect. Resolution will automatically reduce SPL between active audience surfaces

Adaptive Aiming Lines

Resolution now allows users to see the general aiming and allocation of sources in Adaptive arrays. Though this view is simplified (2 lines per enclosure), it provides users with a quick visual indication of how the array is covering the audience and if any areas of the venue are shadowed (Adaptive arrays will not 'shoot' through one surface to reach another). Additionally, users can quickly assess the 'throw' or coverage distance to various audience areas by simply reading the distance associated with each aiming line.

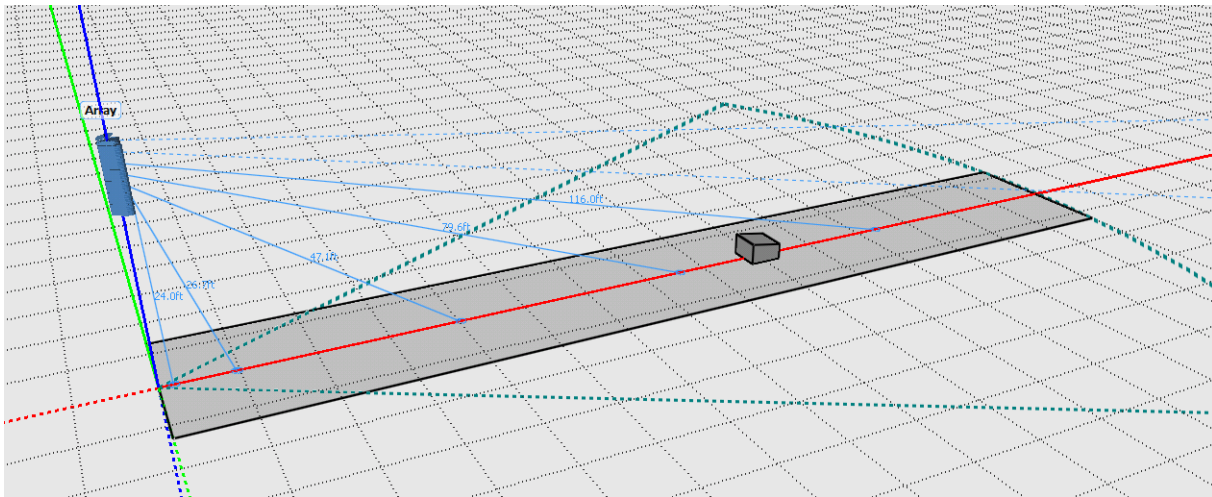

Array Assistant with Mixed Full Range + Subwoofer Arrays



Resolution's Array Assistant will now fully optimize splay angles for arrays with mixed full-range and subwoofer modules, making products like RADIUS (RSX208L + RSX12), KF (KF730 + SB730) and others even easier to use than before.

An example system is shown below before and after splay optimization:

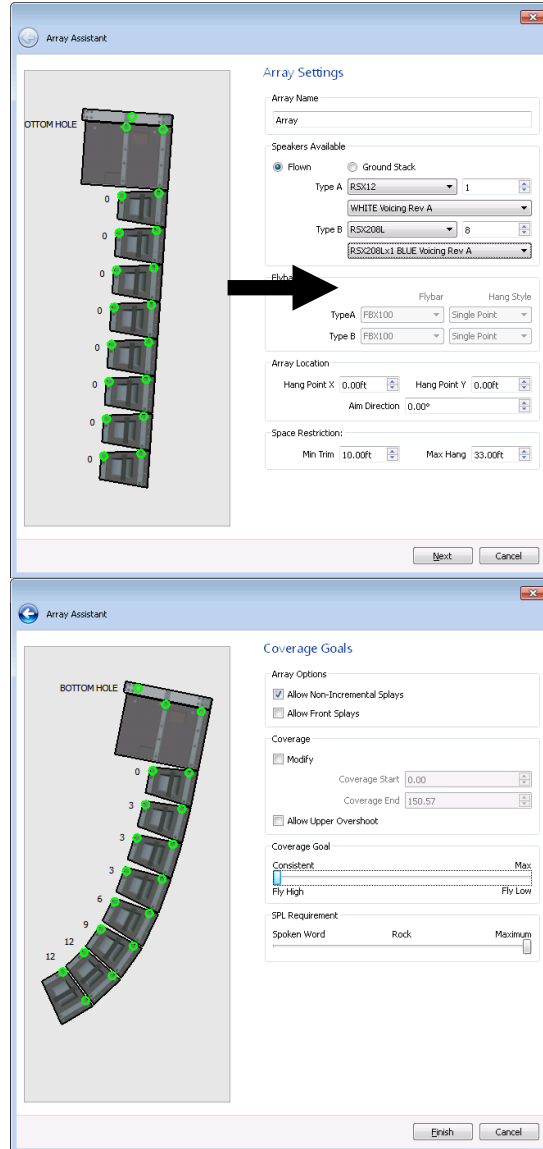

NOTE: it is necessary to include both subwoofers and full-range modules on page 1 of the Array Assistant. Subwoofers will not be included in the array unless a quantity of 1 or more is added to the array by the user.

Other Changes:

- Added "Use Multicast" option when assigning inputs of Adaptive arrays. This permits more than 32 modules to be subscribed to a Dante transmitter (such as an Adaptive module).



- Added warning when attempting to link processing for arrays of different type.
- Improved software update status indications.
- Suppressed tilt sensor warnings for Adaptive systems.
- Added ability for Resolution to save directly to image files (in addition to clipboard).
- Added option to disable acoustic calculations (“Enable Calculations”, under the “View” menu).
- Fixed issue where Otto gain structure was lower than expected in certain rare cases.
- Fixed issue where Resolution could crash when disconnecting from a network.
- Fixed issue where Resolution could crash when deleting Otto modules from an array.
- Improved Otto acoustical model calculations. Resolution will no longer sometimes pause for long periods of time at 40%.
- Improved speed at which Resolution recalculates the acoustic model for Adaptive Systems after changes are made to a design.

Known Issues:

- EASE export may fail for larger Anya arrays.
 - Workaround: Contact EAW Application Support for assistance in exporting EASE balloons for large arrays.
- Reading logs from Adaptive systems can sometimes take a long time or fail.
 - Workaround: Retry log request.
- Coverage lines are not visible on elevated surfaces (greater than $z=0$).
 - Workaround: Rotate 3D venue model perspective vertically (so as to view underside of model) to see location of coverage lines.
- The Array Assistant will sometimes indicate that the array is ‘not aimed at a surface’ for venues built in the $-X$ direction.
 - Workaround: Click ‘OK’, ensure that coverage start and finish are correct, and finish the Array Assistant. The array will be inserted and the acoustic model will still calculate normally.



EAW Resolution v2.1.3.84 Release Notes

Previous Version: EAW Resolution v2.1.3.83

Changes:

Adds EAW RADIUS family loudspeaker data – NOTE: Users may need to enable **loudspeakers** and **flybars** in Resolution Inventory Manager (see Help File for details) in order to use them.

Models include:

- RSX208L line source
- RSX129 and 126 point sources
- RSX89 and 86 point sources
- RSX12 flyable subwoofer
- RSX18 ground-supported subwoofer
- FBX100 flybar for RSX208L and RSX12

Known Issues:

- EASE export may fail for larger Anya arrays.
 - Workaround: Contact EAW Application Support for assistance in exporting EASE balloons for large arrays.
- Reading logs from Adaptive systems can sometimes take a long time or fail.
 - Workaround: Retry log request.
- Coverage lines are not visible on elevated surfaces (greater than $z=0$).
 - Workaround: Rotate 3D venue model perspective vertically (so as to view underside of model) to see location of coverage lines.
- Progress bar for Otto acoustic model sometimes pauses at 40% (20% or 70% for two arrays).
 - Workaround: N/A. Acoustic model calculation time varies by array. Allow calculation to complete.
- The Array Assistant will sometimes indicate that the array is 'not aimed at a surface' for venues built in the $-X$ direction.
 - Workaround: Click 'OK', ensure that coverage start and finish are correct, and finish the Array Assistant. The array will be inserted and the acoustic model will still calculate normally.
- An Adaptive Systems module cannot serve as an on-ramp for more than 32 modules. This occurs because routing is established as unicast flows (which have a limit of 32).



- Workaround: Configure Dante flow from on-ramp module as multicast prior to selecting inputs in Resolution. Audio routing via Resolution (via normal input assignment process) will then be multicast.

EAW Resolution v2.1.3.83 Release Notes

Date: June 6, 2016

Previous Version: EAW Resolution v2.1.2.76

Changes:

- Adaptive Systems Enhancements
 - Improved log files. Saved log files can be opened via File > Open even when the devices are not online.
 - Improved surface detection in design mode.
 - Improvements to Anna fan speed management.
 - Added support for multicast routing.
- General Updates
 - Improvements to the Equalizer View.
 - Resolution “updating” procedure now includes status messages.
 - Minor bug fixes.
 - Includes updated firmware (see Help File for update procedure)
 - Anna (1.0.15.0)
 - Improves stability for systems left powered on continuously for extended periods of time.

Known Issues:

- EASE export may fail for larger Anya arrays.
 - Workaround: Contact EAW Application Support for assistance in exporting EASE balloons for large arrays.
- Reading logs from Adaptive systems can sometimes take a long time or fail.
 - Workaround: Retry log request.
- Coverage lines are not visible on elevated surfaces (greater than z=0).
 - Workaround: Rotate 3D venue model perspective vertically (so as to view underside of model) to see location of coverage lines.



- Progress bar for Otto acoustic model sometimes pauses at 40% (20% or 70% for two arrays).
 - Workaround: N/A. Acoustic model calculation time varies by array. Allow calculation to complete.
- The Array Assistant will sometimes indicate that the array is 'not aimed at a surface' for venues built in the -X direction.
 - Workaround: Click 'OK', ensure that coverage start and finish are correct, and finish the Array Assistant. The array will be inserted and the acoustic model will still calculate normally.
- An Adaptive Systems module cannot serve as an on-ramp for more than 32 modules. This occurs because routing is established as unicast flows (which have a limit of 32).
 - Workaround: Configure Dante flow from on-ramp module as multicast prior to selecting inputs in Resolution. Audio routing via Resolution (via normal input assignment process) will then be multicast.

EAW Resolution v2.1.2.76 Release Notes

Date: February 17, 2016

Previous Version: EAW Resolution v2.1.1.75

Changes:

- Adaptive Systems Enhancements
 - Corrected issue where when utilizing a Dante audio input, Adaptive arrays receiving audio from any source channel other than 1 will indicate an unsynchronized input but actually have the correct channel selected in Dante Controller.
 - Improved communications via Dante API, resulting in significantly faster online system discovery.
 - General Updates
- Minor bug fixes.

Known Issues:

- EASE export may fail for larger Anya arrays.
 - Workaround: Contact EAW Application Support for assistance in exporting EASE balloons for large arrays.
- Reading logs from Adaptive systems can sometimes take a long time or fail.
 - Workaround: Retry log request.



- Coverage lines are not visible on elevated surfaces (greater than $z=0$).
 - Workaround: Rotate 3D venue model perspective vertically (so as to view underside of model) to see location of coverage lines.
- Progress bar for Otto acoustic model sometimes pauses at 40% (20% or 70% for two arrays).
 - Workaround: N/A. Acoustic model calculation time varies by array. Allow calculation to complete.
- The Array Assistant will sometimes indicate that the array is 'not aimed at a surface' for venues built in the $-X$ direction.
 - Workaround: Click 'OK', ensure that coverage start and finish are correct, and finish the Array Assistant. The array will be inserted and the acoustic model will still calculate normally.
- An Adaptive Systems module cannot serve as an on-ramp for more than 32 modules. This occurs because routing is established as unicast flows (which have a limit of 32).
 - Workaround: Configure Dante flow from on-ramp module as multicast prior to selecting inputs in Resolution. Audio routing via Resolution (via normal input assignment process) will then be multicast.

EAW Resolution v2.1.1.75 Release Notes

Date: December 17, 2015

Previous Version: EAW Resolution v2.1.0.45

Changes:

- Adaptive Systems Enhancements
- Added Anna and capabilities to generate Anna and mixed Anya/Anna arrays to Array Assistant.
- Added Adaptive Parameter Sync feature, which continually monitors and reports synchronization status between Resolution and Adaptive Arrays.
- Added ability to utilize multiple hang styles within a multi-column Adaptive array (accessed by the 'Properties' pane at the column level).
- Added option to ignore Tilt Errors for Adaptive products, as well as Previous/Next paging buttons for warning banners.
- Improved Acoustic Measurement function for Otto and Anna. As a result, users no longer need to 'Calibrate' after driver replacement (still required for Anya).
- Includes most recent voicings for Anya and Otto to maximize compatibility, reliability and performance.
 - Overall Usability Improvements



- Improved SPL mapping on “Fastest” and “Normal” interpolation levels, reducing calculation time by up to 80% (model-dependent).
- Added Laser and Cartesian data entry options for improved workflow when using laser distance meters and CAD drawings (respectively) to create venue models.
- Added Copy, Paste and Link functions for mirroring equalization across multiple arrays.
- Increased maximum delay time in Array Processing window from 100 milliseconds to 1,200 milliseconds.
- Added ability to modify quantity of modules in a column or array from Properties pane.
- Removed ‘Overshoot’ Array Assistant function.
- Added capability to create trapezoidal audience areas.
- Added ‘Global Ear Height’ setting.
- Improved reporting of maximum hang quantities for arrays.
- Improved legibility of virtual microphone SPL in certain situation.
- Corrected issue where Array Assistant-generated arrays can sometimes extend below minimum defined trim.
- Corrected bug where EQ enable/disable state would not store with .eawresolution file.
 - Network & Dante Improvements
- Added ability to select both primary and secondary network interfaces.
- Non-EAW products are now listed first in Device List.
- Improved communications via updated Dante API.
 - General Updates
- Minor bug fixes.
 - Updated Help File.

Known Issues:

- When utilizing a Dante audio input, Adaptive arrays receiving audio from any source channel other than 1 will indicate an unsynchronized input, but actually have the correct channel selected in Dante Controller.
 - Workaround: None needed – this is a visual bug only. The arrays have the correct input assigned, as indicated in Dante Controller.
- EASE export may fail for larger Anya arrays.



- Workaround: Contact EAW Application Support for assistance in exporting EASE balloons for large arrays.
- Reading logs from Adaptive systems can sometimes take a long time or fail.
 - Workaround: Retry log request.
- Coverage lines are not visible on elevated surfaces (greater than $z=0$).
 - Workaround: Rotate 3D venue model perspective vertically (so as to view underside of model) to see location of coverage lines.
- Progress bar for Otto acoustic model sometimes pauses at 40% (20% or 70% for two arrays).
 - Workaround: N/A. Acoustic model calculation time varies by array. Allow calculation to complete.
- The Array Assistant will sometimes indicate that the array is 'not aimed at a surface' for venues built in the $-X$ direction.
 - Workaround: Click 'OK', ensure that coverage start and finish are correct, and finish the Array Assistant. The array will be inserted and the acoustic model will still calculate normally.
- An Adaptive Systems module cannot serve as an on-ramp for more than 32 modules. This occurs because routing is established as unicast flows (which have a limit of 32).
 - Workaround: Configure Dante flow from on-ramp module as multicast prior to selecting inputs in Resolution. Audio routing via Resolution (via normal input assignment process) will then be multicast.

EAW Resolution v2.1.0.45 Release Notes

Date: December 18, 2014

Previous Version: EAW Resolution v2.0.3.50

Changes:

- Added Otto Adaptive Subwoofer and Otto Array Assistant.
- Several improvements to Network Configuration View for Adaptive systems, including:



- Improved array self-recognition speed and accuracy.
- Added progress bars for improved array feedback.
- Added the ability to reboot modules remotely.
- Added LED options to Array Configuration dialogue for Adaptive Module.
- Added the ability to change inputs even if one or more module is offline.
- Improved handling of communication errors via progress bars and pop-up dialogs.
- Users now have the option to drive multi column Anya arrays either Adaptively or Uniformly (see Help File for more detail).
- Anya and Otto 3D enclosure and flybar models are now significantly more detailed and realistic.
- Adaptive systems acoustical model calculations are now more efficient; calculation time is greatly reduced.
- X, Y and Z-axis lines in the negative direction are now dashed for easier identification.
- Numbering of array elements now only includes loudspeakers (accessories such as flybars and adapter bars are tracked with letters instead of numbers) for easier array size identification.
- General minor bug fixes.
- Updated Help File.
- Includes updated firmware (see Help File for update procedure)
 - Anya (1.0.39.0)
 - § Adds level- and temperature-dependent fan speed control.
 - § Power Plants now keep input panel "Test" indicator illuminated while powered on for improved visibility of module status.
 - Otto (0.1.9.0)
 - § Initial release.

Known Issues:

- EASE export may fail for larger Anya arrays.
 - Workaround: Contact EAW Application Support.
- Reading logs from Adaptive systems can sometimes take a long time or fail.
 - Workaround: Retry log request.
- Coverage lines are not visible on elevated surfaces (greater than z=0).
 - Workaround: Rotate 3D venue model vertically to see location of coverage lines.



- Virtual microphone SPL text sometimes does not display properly with complex surface geometries.
 - Workaround: Rotate 3D venue model to see text.
- Array Assistant-generated arrays can sometimes extend below minimum defined trim in situations with very tight height constraints.
 - Workaround: Re-run Array Assistant with reduced array size until constraints are met.
- Progress bar for Otto acoustic model sometimes pauses at 40% (20% or 70% for two arrays).
 - Workaround: N/A. Acoustic model calculation time varies by array.

EAW Resolution v2.0.3.50 Release Notes

Date: July 7, 2014

Previous Version: EAW Resolution v2.0.2.48

Changes:

- Enhanced implementation of Air Loss Compensation for very long throw distances using Anya.
- Improved handling of audience surfaces shadowed from array coverage in complex venue geometries.
- Updated "Create PDF" function for Anya arrays, no providing significantly more detail about rigging points and loads.
- Inclusion of updated Audinate Dante Redistributable, no longer requiring some users to install it separately.
- General minor bug fixes.

EAW Resolution v2.0.2.48 Release Notes

Date: April 25, 2014

Previous Version: EAW Resolution v2.0.1.39

Changes:

- Added display of current cursor position 3D coordinate and SPL value.
- Added trace storage capability for virtual microphone frequency responses.



- Added audience ear height selection for each surface (used for SPL mapping, virtual microphone placement and array coverage calculation).
- Minor improvements to mechanical calculations in Array Wizard, particularly for mixed-model arrays.
- Removed dimensional limitations on ground-stack stage height.
- Added "Mic SPL" toolbar button for even faster SPL calculation.
- Improved "Copy image to clipboard" function.
- Improved Network Configuration View functionality, including:
 - "Unassign All" right-click option for Anya arrays.
 - Array placement on page is retained with file.
 - Improved Anya-related functionality:
 - Addition of "Sapphire" voicing.
 - Improved EASE export function for Anya arrays. All columns in multi-column arrays now export as single balloon.
 - Improved acoustic model recalculation workflow.
 - Minor improvements to Adaptive Performance™ algorithm to handle unusual audience geometries and air loss pre-emphasis for longer throws.
 - Find Me (Trilateration) function process now includes more comprehensive dialogs.
 - Improved "Auto Identify" behavior; LEDs now turn off after 10 seconds or immediately on deselect.
- Anya banner warnings are more specific.
 - Updated Help File.
 - General minor bug fixes.

EAW Resolution v2.0.1.39 Release Notes

Date: February 19, 2014

Previous Version: EAW Resolution v2.0.1.28

Changes:

Improved graphical functionality, including:

- Addition of zoom +/- functionality for frequency response window.



- Users can now define the Y-value of the cross-sectional view in X-Z view.
- Improved visibility of SPL microphones.
- Added "Unsolo All Arrays" toolbar button.
- Addition of shortcut keys and menu options for Free, Side and Top views.
 - Enhanced menu operation including additional right-click functions such as:
- "Clone" feature for virtual microphones in Venue Configuration window.
- Direct access to processing for Arrays and Loudspeakers in Project Explorer window.
- "Add Array", "Add Surface" and "Add Mic" in Venue Configuration window.
 - Improved "Create PDF" output and refined mechanical calculations for some loudspeaker models.
 - Added option to manually recalculate acoustic model if desired.
 - Improved handling of non-English characters.
 - Refined integration with Anya systems:
- Further improved "Upload Array Parameters" behavior when making changes to model.
- Added ability to define LED behavior.
- Improved handling of low-frequency coverage for Anya arrays in certain near-field scenarios, and overall EQ optimization.
- This installer also includes Anya voicing version 1.5 (see release notes under "Inventory Manager" for details). Previous voicing revisions are still included.
 - General minor bug fixes.

EAW Resolution v2.0.1.28 Release Notes

Date: August 22, 2013

Previous Version: EAW Resolution v2.0.0.26

Changes:

- Array Assistant improvements & bug fixes - "Array Wizard" changed to "Array Assistant", moved aim angle to, default coverage changed from 180 to 90 degrees, online array editing improvements
- Coverage assignment improvements - Asymmetrical horizontal coverage fields allowed (relative to array)



- Frequency Response window improvements - added CSV export, copy to clipboard to right click menu, toggle icon bar auto re-size
- Anya diagnostic screen improvements - more intelligent impedance feedback, acoustic measurement improvements
- Added toolbar options - hide all floors button, undo/redo buttons, file & edit toolbars
- Acoustic/SPL workflow improvements - less recalculations & button presses required
- Microphones improvements & bug fixes - Microphones can be locked, "Find Me!" results default to locked
- Array & surface naming improvements & bug fixes - "floor" changed to "surface"

EAW Resolution v2.0.0.26 Release Notes

Date: August 6, 2013

Previous Version: EAW Resolution v1.3.1.39

Changes:

- Initial release of EAW Resolution 2.0

For all questions, please contact design@eaw.com