

WAYBOM A Reliable Partner

- ▶ Get the latest aluminum profiles and hardware for any project, with our superior stock and R&D capabilities.

Foshan Waybom Aluminum Co.,Ltd

Office Address: Room 1606, Weiye International Building, No.75 Lingnan Road, Nanhai, Foshan, Guangdong, China

| www.wb-aluminum.com/ |     Follow us on: waybom aluminum



15 YEARS

for exterior door and windows industry



COMPANY PROFILE >>>

Dear valued customers, welcome to Waybom Aluminum! We are a professional manufacturer of high-quality aluminum profiles for interior and exterior doors, with over 15 years of experience in the industry.

We specialize in producing aluminum profiles for a range of door types, including bi-folding doors, sliding doors, swing doors. At Waybom Aluminum, we understand the importance of having everything in one place, that's why we supply all related hardware to ensure that you can get everything you need from us.

Our state-of-the-art facility includes our own aluminum extruding lines and powder coating workshop, which allows us to ensure that each order is of the same color and design. We also have more than 5000 tons of stock available, which means that we can supply any quantity without a MOQ. For products in stock, we can deliver in just 7 days.

At Waybom Aluminum, we are committed to providing our customers with customized solutions that meet their unique design requirements. Our team of experts can work with you to create custom solutions according to your specific needs. We also have an R&D department that ensures we have the newest designs in the market. Whether you are a distributor or fabricator, you can count on us to provide you with all the support you need.

Thank you for considering Waybom Aluminum for your aluminum profile and hardware needs. We look forward to working with you and providing you with the highest quality products and services.



CATALOG

01 – EXTERIOR SLIDING SYSTEM

- | | |
|--|------|
| A. 150 panoramic sliding door | P 01 |
| B. ZP150 motorized vertical sliding window | P 08 |
| C. 130+195 heavy-duty lift sliding door | P 13 |
| D. 128 floating sliding window | P 27 |
| E. 130 lift sliding window | P 35 |

02 – EXTERIOR CASEMENT SYSTEM

- | | |
|--|------|
| A. 120-1# slim casement window | P 41 |
| B. 110-3# slim casement window | P 45 |
| C. 110 #3 outside& inside opening window | P 48 |
| D. 90-1# new casement window | P 53 |
| E. casement door bottom threshold series | P 61 |

03 – EXTERIOR FOLDING SYSTEM

- | | |
|---------------------------------------|-------|
| A. 50 upper lift window | P 62 |
| B. 45/50/60 upper folding window | P 65 |
| C. 42 free folding door/window | P 69 |
| D. 50 anti-pinch folding door/window | P 73 |
| E. 58pro fully sealed folding door | P 79 |
| F. 75KS medium narrow folding door | P 87 |
| G. 75HOPO folding door | P 92 |
| H. 75 large folding door | P 96 |
| I. 120 anti-pinch folding door/window | P 100 |

150 Panoramic Sliding Door >>>

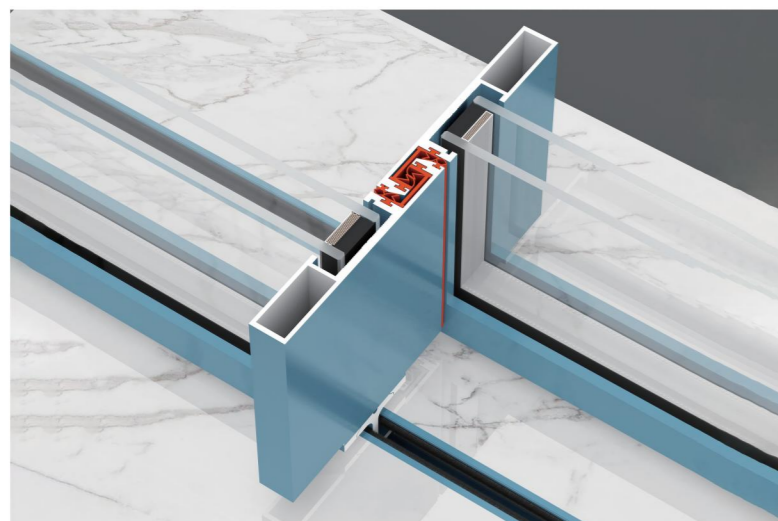

Product Features :

- ① The visible surface of the vertical door frame is only 25mm
- ② Double rows of customized stainless steel pulleys, the load-bearing capacity of a single fan can reach 1500kg.
- ③ Micro-slit lower track design for better drainage performance.

▶ 150 Panoramic Sliding Door

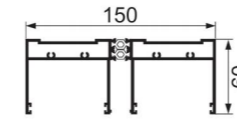

WB150-A2

two panels horizontal top track
Weight : 2.9 kg/m

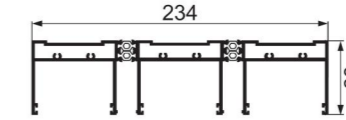

WB150-SG1

three panels horizontal top track
Weight : 4.57 kg/m

▶ 150 Automatic Panoramic Sliding Door

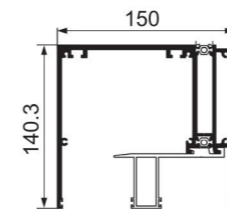

WB150-A4B

automatic two panels horizontal top track
Weight : 6.1 kg/m

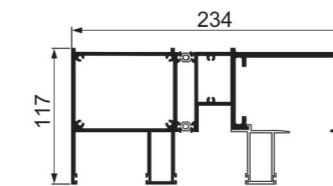

WB150-SL01

automatic three panels horizontal top track
Weight : 8.54 kg/m

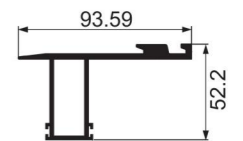

WB150-16

two panels horizontal top track assistance
Weight : 1.59 kg/m

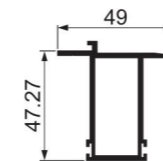

WB150-SL03

two panels horizontal top track assistance
Weight : 1.13 kg/m

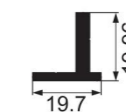

WB150-SL02

telescopic horizontal top panel frame assistance
Weight : 0.32 kg/m

► **Universal Profiles**

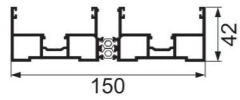

WB150-XA1
two panels vertical outer frame
Weight : 2.74 kg/m

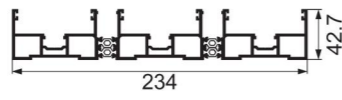

WB150-SG3
three panels vertical outer frame
Weight : 4.57 kg/m

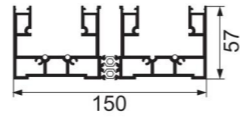

WB150-A3
two panels horizontal bottom track
Weight : 3.8 kg/m

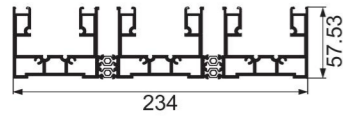

WB150-SG2
three panels horizontal bottom track
Weight : 6.1 kg/m

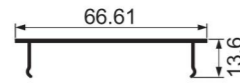

WB150-13
vertical & horizontal top frame covered
Weight : 0.27 kg/m

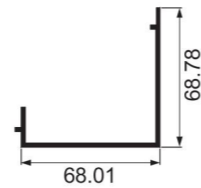

WB150-21
sink
Weight : 0.84 kg/m



WB150-20
sink cover
Weight : 0.73 kg/m

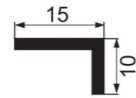

WBL10*15
sink covered support part
Weight : 0.12 kg/m

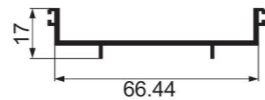

WB150-27
bottom track ceramic panel middle covered
Weight : 0.41 kg/m

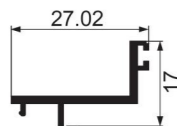

WB150-26
bottom track ceramic panel side covered
Weight : 0.18 kg/m



WB150-47
vertical interlock frame with strong handle
Weight : 2.4 kg/m

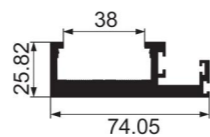

WB150-59
vertical interlock frame
Weight : 1.91 kg/m

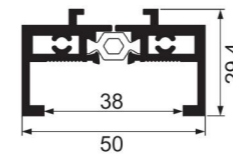

WB150-A6
horizontal top frame
Weight : 1.06 kg/m

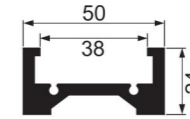

WB150-08
horizontal bottom frame
Weight : 1.22 kg/m

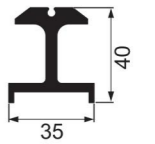

WB150-28
horizontal bottom frame base for roller
Weight : 1.16 kg/m

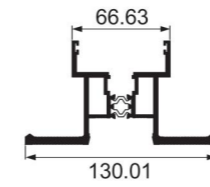

WB150-C7
double openable vertical sealing frame
Weight : 3.1 kg/m

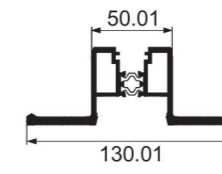

WB150-C5
vertical frame with handle
Weight : 2.58 kg/m

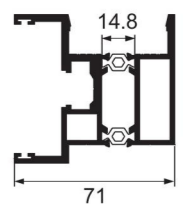

WB150-C8
90 degree corner vertical sealing frame
Weight : 2.2 kg/m

► **Assembly Diagram**



One fixed and one movable

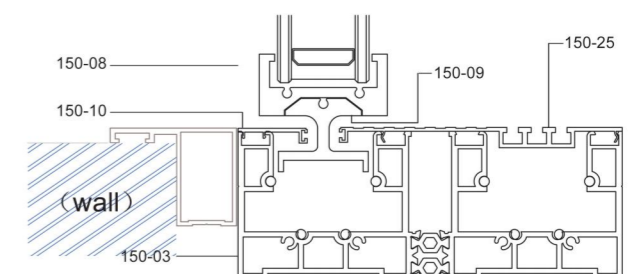
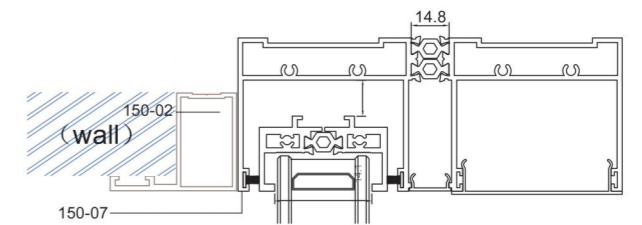

► Assembly Diagram

Low rail and below without pre-embedded plan

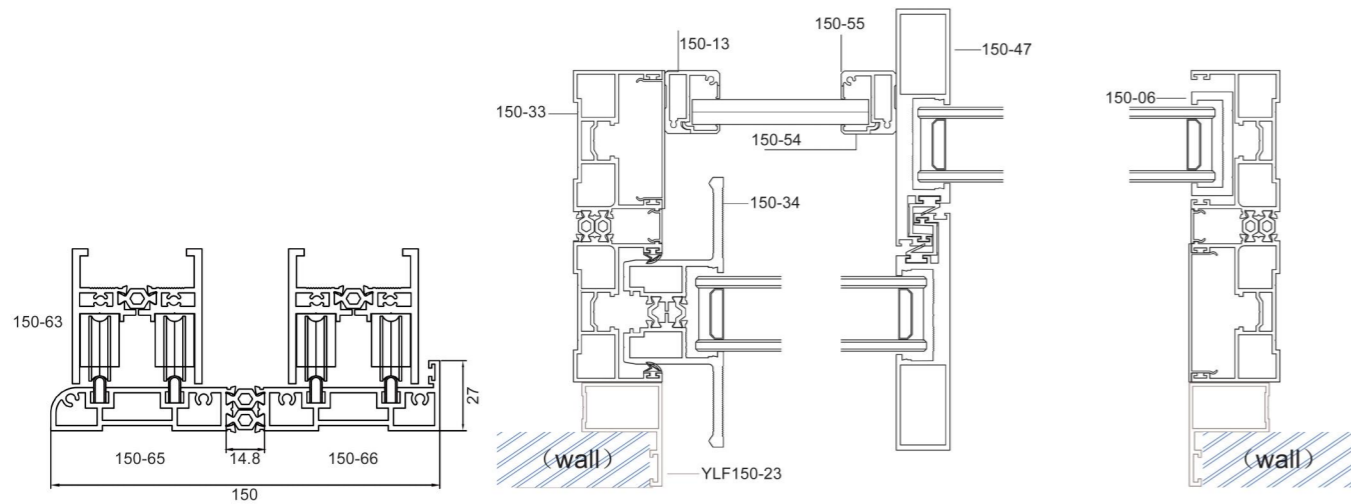

Two door movable assembly drawings

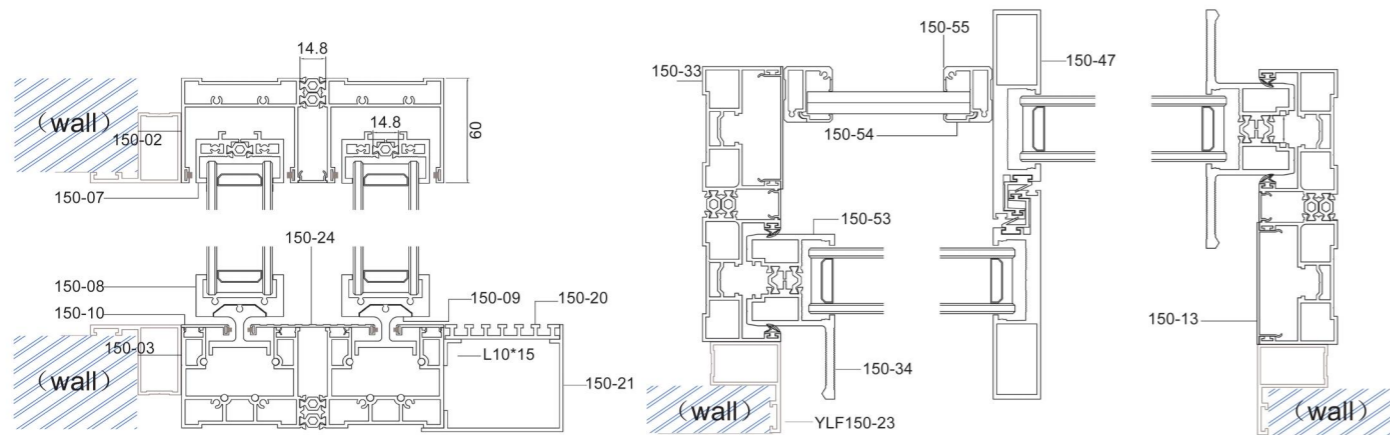

► Assembly Diagram

Three-track assembly drawing
(can have as many tracks as you like)

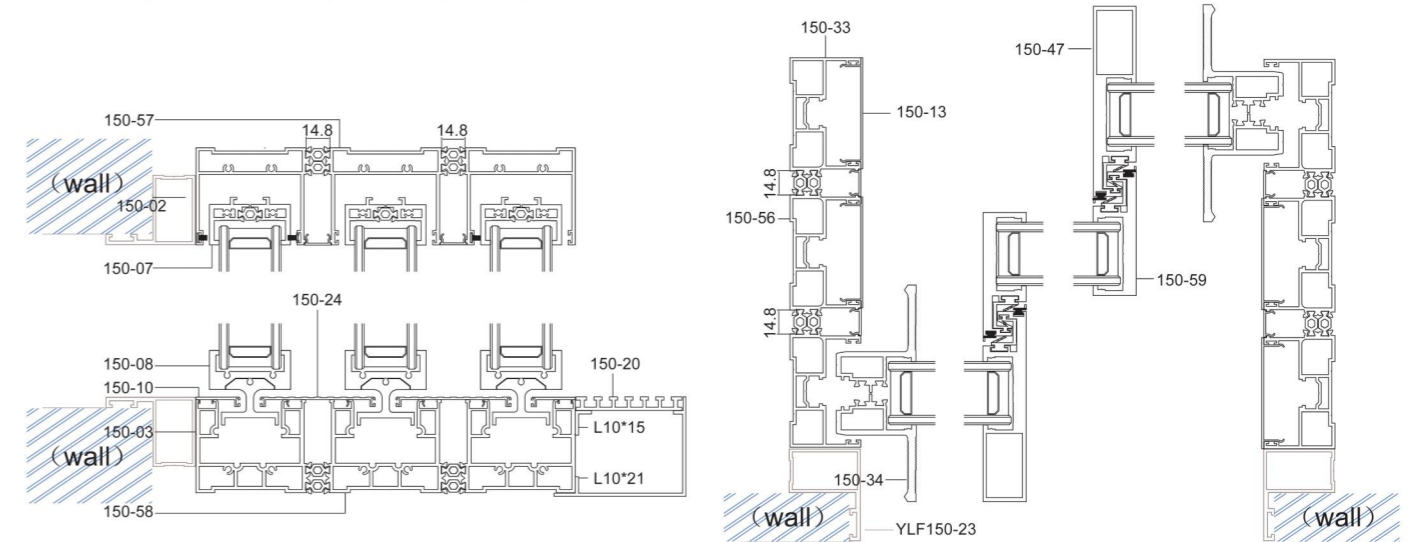

150 Panoramic door and window triple linkage with marble track assembly drawing

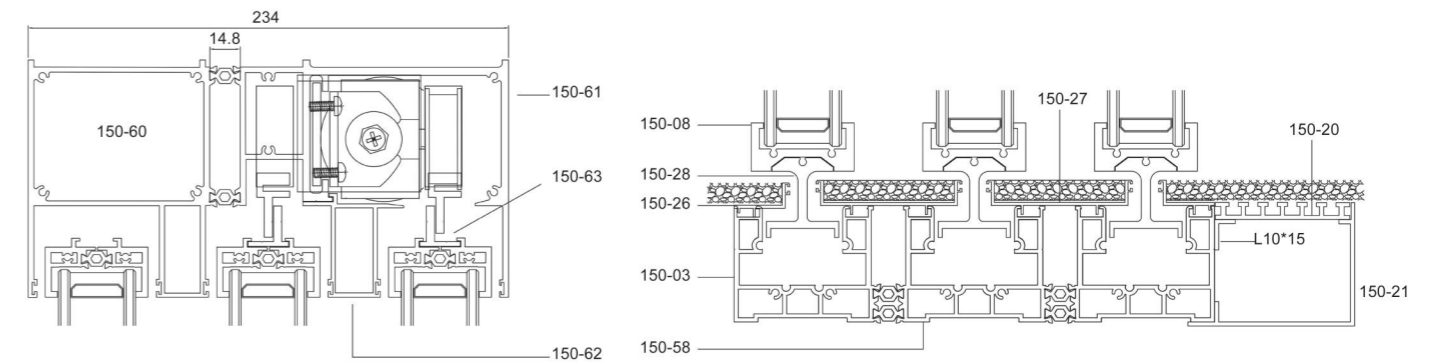

▶ Accessories



top track roller
(Positioning wheel) -2pcs/panel



50cm length bottom track roller
(Load-bearing wheels) -2pcs/panel

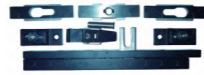

I shape lock

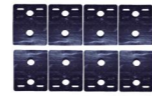

cap for both side vertical
outer frame(8pcs/set)



anti-collision rubber for
vertical interlock frame(left)



anti-collision block for
vertical handle frame



drainage cap for
bottom track

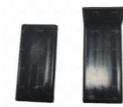

cap for vertical interlock
frame(top & bottom)



water proof rubber
pad for bottom track



brush strip for
bottom track covered



anti-collision rubber for
vertical interlock frame



water blocking strip for
vertical outer frame

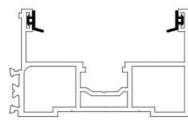

sealing rubber for
vertical outer frame

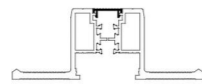

covered rubber for
vertical handle frame



sealing rubber for
vertical interlock frame

*AUTOMATIC OPTIONS:

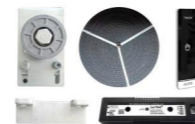

Electric motor accessories set

*AUTOMATIC OPTIONS:



infrared induction
anti-pinch equipment

*AUTOMATIC OPTIONS:



human body induction probe automatic
door opening and closing equipment

*AUTOMATIC OPTIONS:



wireless infrared
air sensor switch

*AUTOMATIC OPTIONS:



face recognition
access control

ZP150 Motorized Vertical Sliding Window >>>

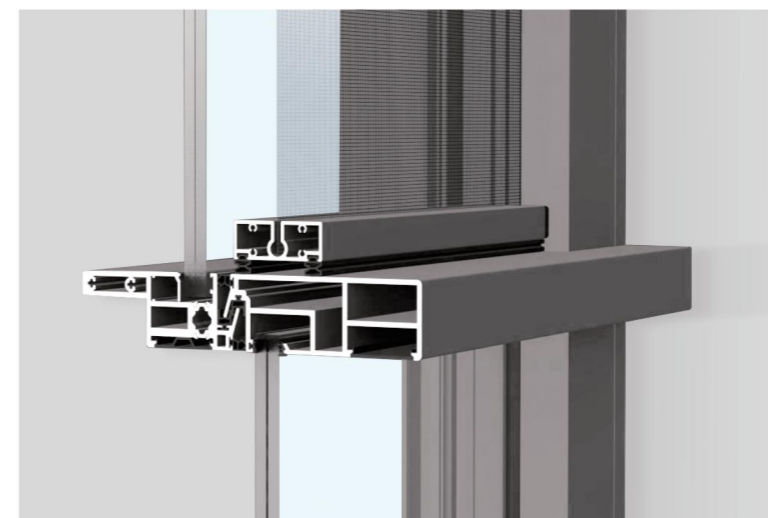

Product Features :

- ① Two motors, chain drive, wide field of view
- ② Rain sensor, automatic closing when it rains
- ③ Maximum width 4.8m, maximum height 2.5m
- ④ Infrared anti-pinch design, can be equipped with anti-mosquito screens

► ZP150 Motorized Vertical Sliding Window

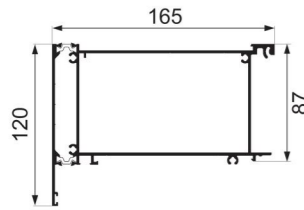

JNW-SJC22A
150 upper frame
Weight : 4.04 kg/m

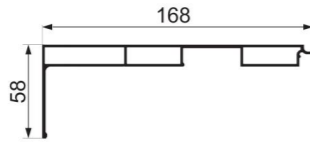

JNW-ZN023
screen cover
Weight : 1.71 kg/m

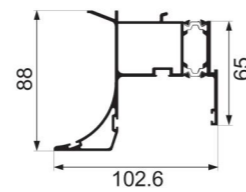

JNW-SJC24A
screen upper frame
Weight : 2.29 kg/m

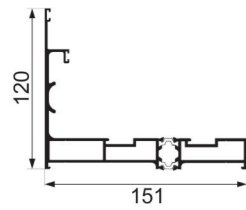

JNW-SJC26A
150 side frame
Weight : 3.34 kg/m

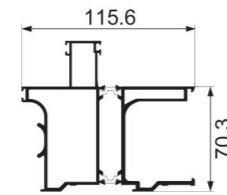

JNW-SJC28A
150 side frame transform
Weight : 3.29 kg/m

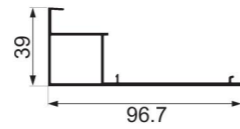

JNW-ZN029
150 side frame cover
Weight : 0.8 kg/m

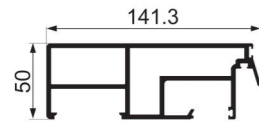

JNW-ZN031
150 handrail
Weight : 3.8 kg/m

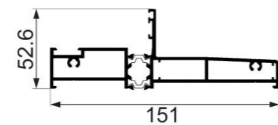

JNW-SJC33A
150 lower frame
Weight : 2.68 kg/m

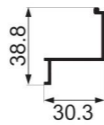

JNW-ZN032
not screen mesh closing
Weight : 0.3 kg/m

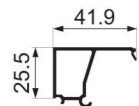

JNW-ZN034
clip
Weight : 0.47 kg/m

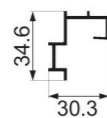

JNW-ZN036
screen frame
Weight : 0.35 kg/m

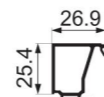

JNW-ZN035
clip
Weight : 0.41 kg/m

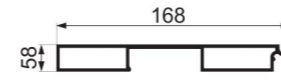

JNW-ZN037
150 not screen mesh cover
Weight : 1.0 kg/m

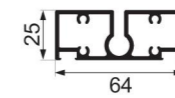

JNW-ZN030
screen profile
Weight : 1.31 kg/m

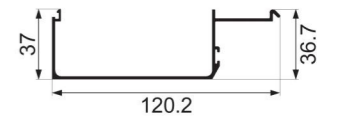

JNW-ZN038
150 upper frame cover
Weight : 0.85 kg/m

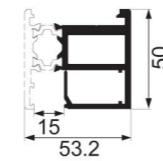

JNW-SJC09
glass door panel
Weight : 2.25 kg/m

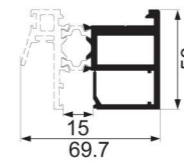

JNW-SJC12
glass door with hook
Weight : 2.58 kg/m

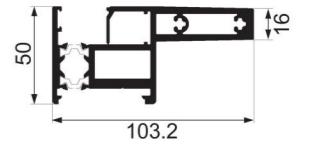

JNW-SJC23
strengthen glass door
Weight : 3.39 kg/m

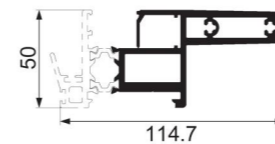

JNW-SJC25
strengthen glass door with hook
Weight : 3.72 kg/m

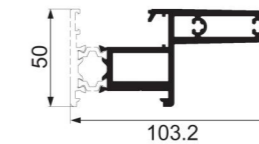

JNW-SJC31
strengthen glass door
Weight : 3.25 kg/m

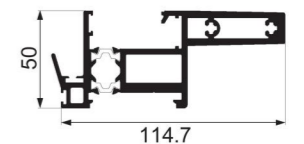

JNW-SJC33
strengthen glass door with hook
Weight : 3.58 kg/m

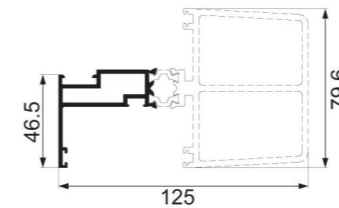

JNW-SJC14
strengthen inner frame
Weight : 3.98 kg/m

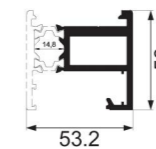

JNW-SJC039
glass door panel
Weight : 2.05 kg/m

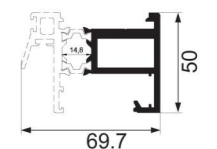

JNW-SJC041
glass door with hook
Weight : 2.38 kg/m

► Assembly Diagram

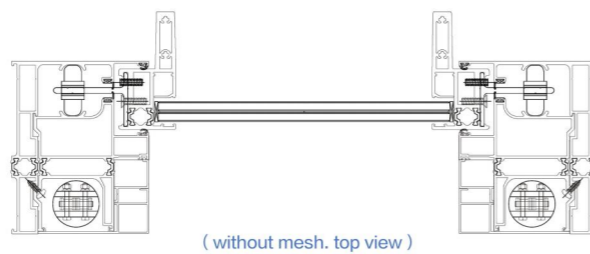
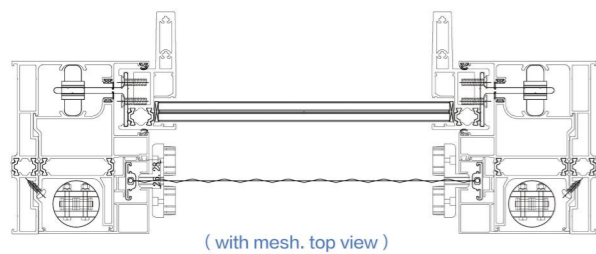
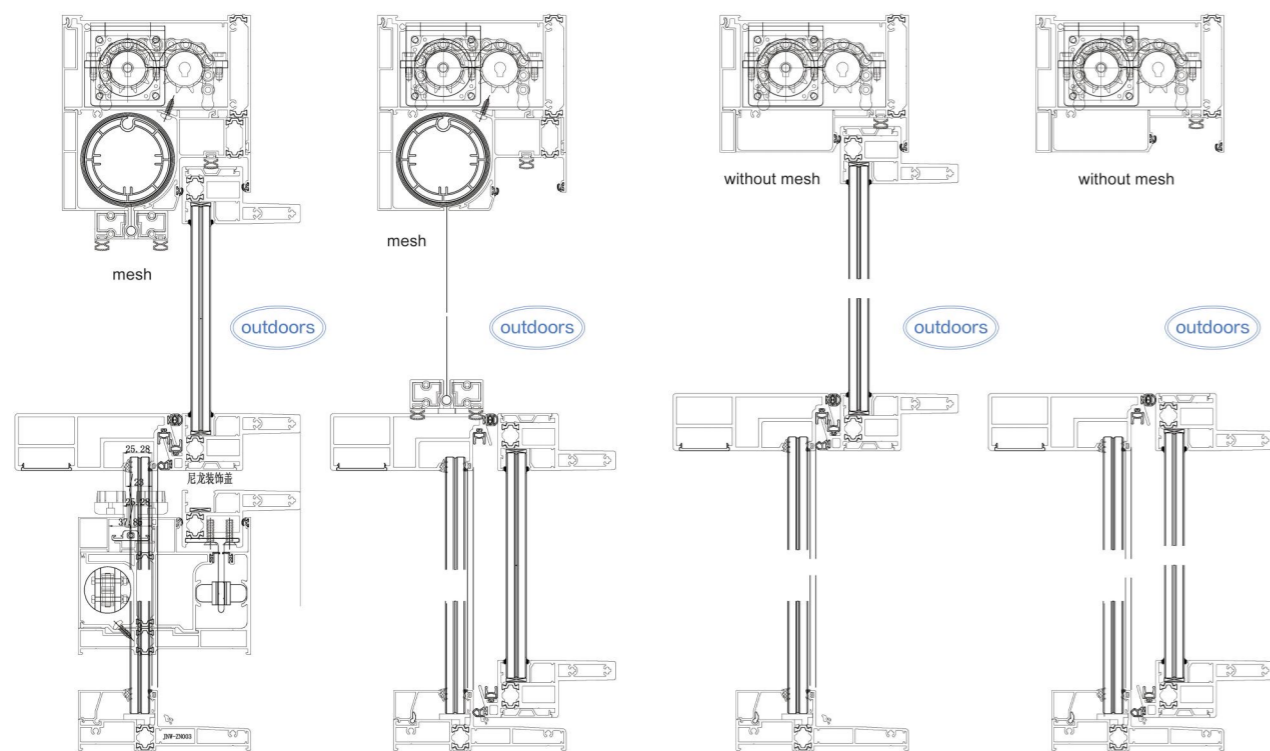

► Accessories



battery backup



handrail pc cover



opening sash pc cover



lifting arm

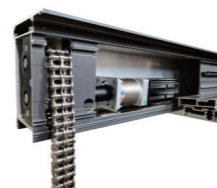

motor



intelligent voice sensor

130+195 Heavy-Duty Lift Sliding Door >>>



Product Features :

- ① Hidden bottom rail floor drain design
- ② Lifting sliding for better sealing performance
- ③ Positioned at will, easy to adjust the ventilation area
- ④ Sound and heat insulation, energy efficient

▶ 130+195 Thermal Break Profiles

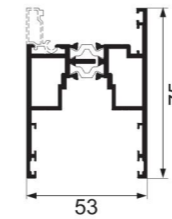

JNW-TS911F

75 lifting door
Weight : 1.79 kg/m

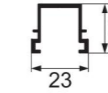

JNW-XT914

75 door slot
Weight : 0.23 kg/m

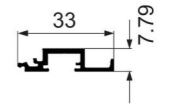

JNW-XT936

75 vertical door frame with hook
Weight : 0.20 kg/m

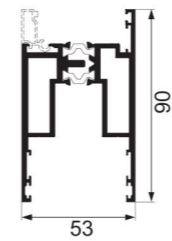

JNW-TS1281F

90 lift gate
Weight : 2.53 kg/m

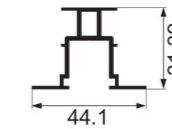

JNW-XT1488

90 liftgate slot
Weight : 0.50 kg/m

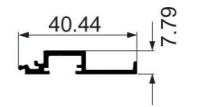

JNW-XT1284

90 vertical door frame with hook
Weight : 0.23 kg/m

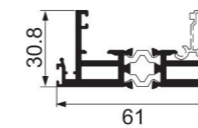

JNW-TS929F

inside slim vertical door frame
Weight : 1.23 kg/m

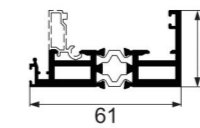

JNW-TS935F

outside slim vertical door frame
Weight : 1.23 kg/m

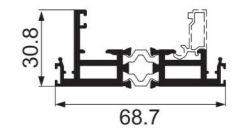

JNW-TS930F

double vertical door frame with hook
Weight : 1.32 kg/m

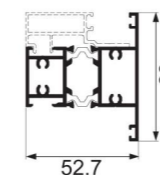

JNW-TS939F

screen center
Weight : 1.37 kg/m

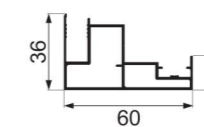

JNW-A-042

60 bale cover
Weight : 0.77 kg/m

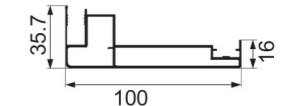

JNW-A-018

100 bale cover
Weight : 1.05 kg/m

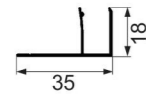

JNW-A-016
f groove
Weight : 0.18 kg/m

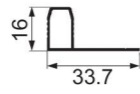

JNW-A-015
p-strip
Weight : 0.18 kg/m

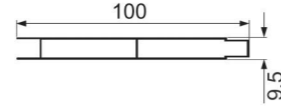

D-A470
100 buckle plate
Weight : 0.49 kg/m

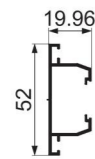

JNW-XT924F
side closure slots
Weight : 0.44 kg/m

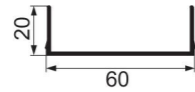

JNW-XT951
side sealing cover plate
Weight : 0.37 kg/m

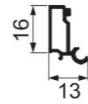

JNW-XT913D
door clip
Weight : 0.15 kg/m



JNW-XT1080F
fixing glass door clip
Weight : 0.18 kg/m

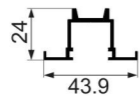

JNW-XT1008
75 intelligent lock slot
Weight : 0.42 kg/m

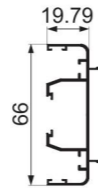

JNW-XT931F
closing
Weight : 0.66 kg/m



JNW-XT937
single vertical door frame with hook
Weight : 0.27 kg/m



JNW-XT953
double vertical door frame with hook
Weight : 0.31 kg/m

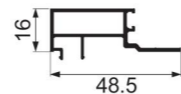

JNW-XT915
diamond mesh sub-frame
Weight : 0.41 kg/m

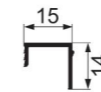

JNW-XT916
diamond mesh clip
Weight : 0.10 kg/m

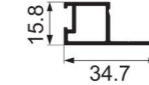

JNW-XT1217
highly transparent mesh sub-frame
Weight : 0.45 kg/m

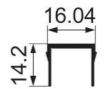

JNW-XT1218
highly transparent mesh clip
Weight : 0.12 kg/m

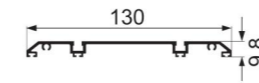

JNW-A-009
two rail flat rail
Weight : 0.89 kg/m

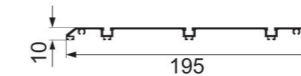

JNW-A-020
three track flat track
Weight : 1.28 kg/m

► Automatic Profiles



JNW-XT863
intelligent two-rail top rail
Weight : 1.63 kg/m

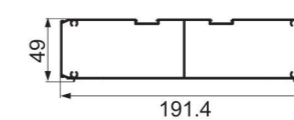

JNW-XT861
intelligent three-rail top rail
Weight : 2.35 kg/m

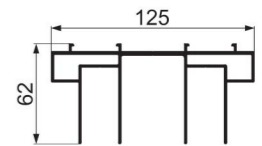

JNW-XT864
intelligent two-rail additional rail
Weight : 2.18 kg/m

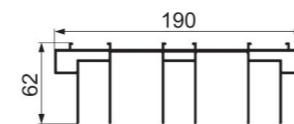

JNW-XT862
intelligent three-rail additional rail
Weight : 3.23 kg/m

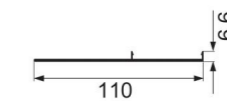

JNW-XT860
intelligent top rail cover
Weight : 0.50 kg/m

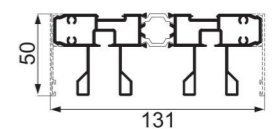

JNW-TS918F
lifting two-rail top rail
Weight : 2.84 kg/m

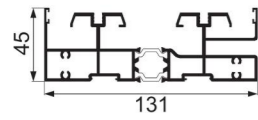

JNW-TS921F

lifting two-rail bottom rail
Weight : 3.0 kg/m

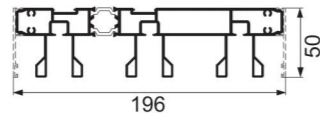

JNW-TS952F

lifting three-rail top rail
Weight : 4.0 kg/m

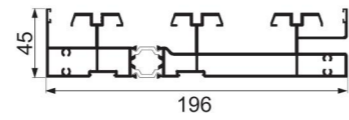

JNW-TS955F

lifting three-rail bottom rail
Weight : 4.05 kg/m

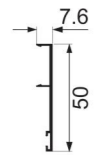

JNW-XT917

lift the top rail cover plate
Weight : 0.23 kg/m

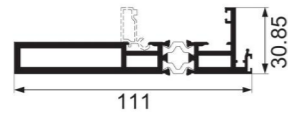

JNW-TS1121F

reinforce inner vertical door frame
Weight : 2.11 kg/m

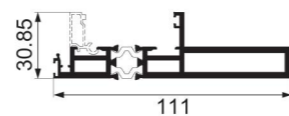

JNW-TS1122F

outside reinforced vertical door frame
Weight : 2.11 kg/m

► **Sinking And Embedded Profiles**

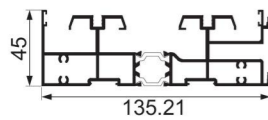

JNW-TS1120G

pre-embedded two-rail bottom rail
Weight : 3.09 kg/m

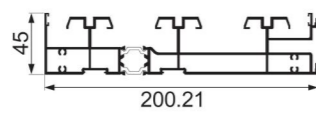

JNW-TS1519F

pre-embedded three-rail bottom rail
Weight : 4.17 kg/m

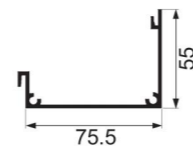

JNW-XT1119G

pre-embedded sinking hidden drain
Weight : 0.97 kg/m

► **Universal Profiles**

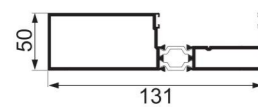

JNW-BF923F

two rail side seal
Weight : 1.93 kg/m

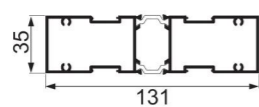

JNW-ZT938F

two rail inner frame
Weight : 2.0 kg/m

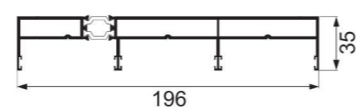

JNW-BF950F

three-rail side seal
Weight : 2.74 kg/m

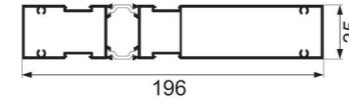

JNW-ZT954F

three track inner frame
Weight : 2.68 kg/m

► **Assembly Diagram**

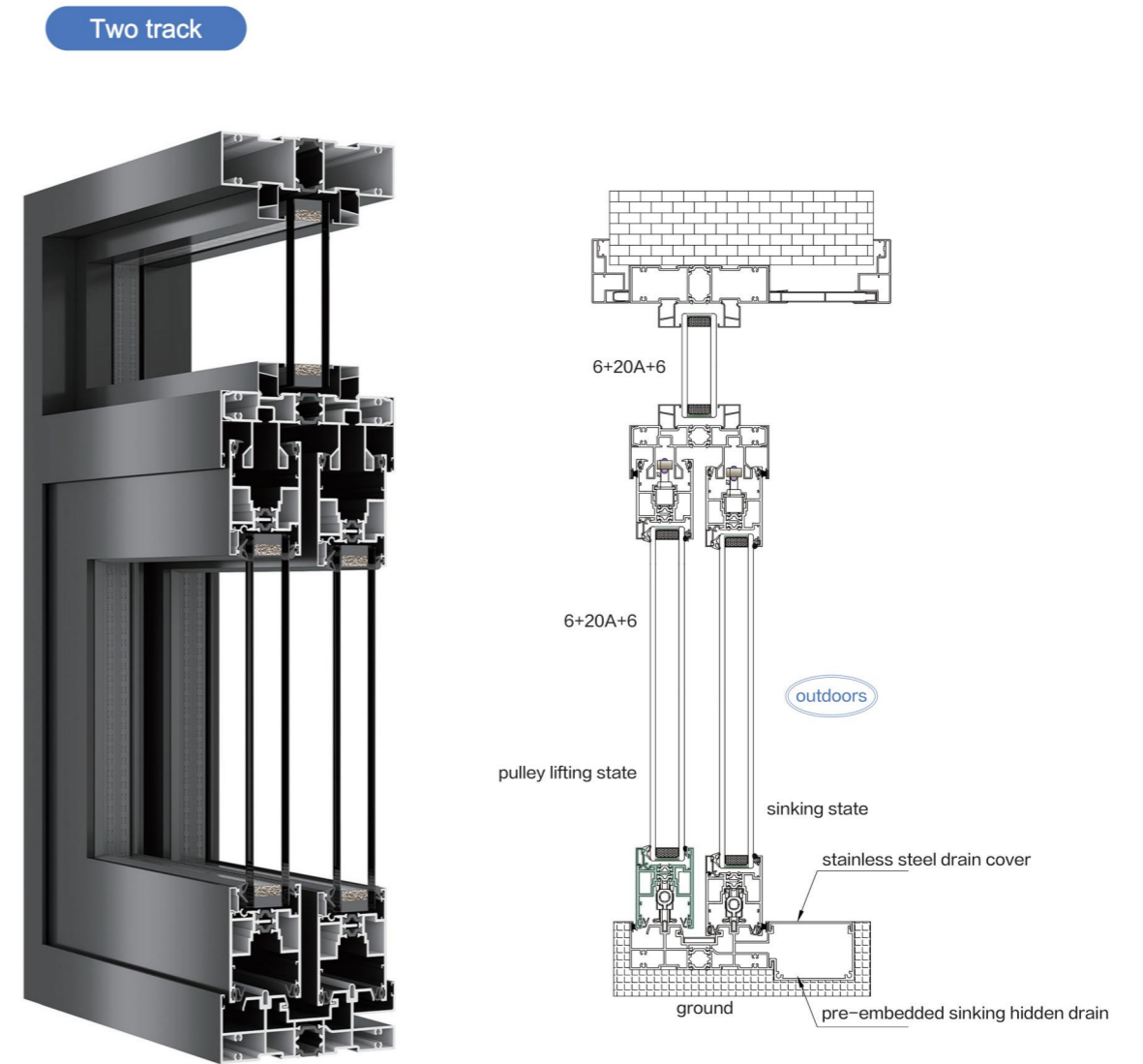

Triple track

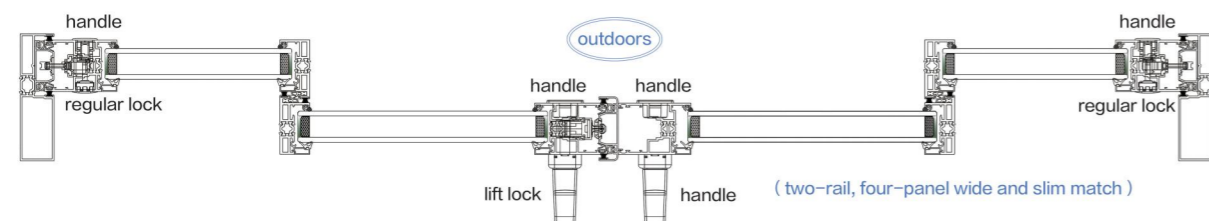
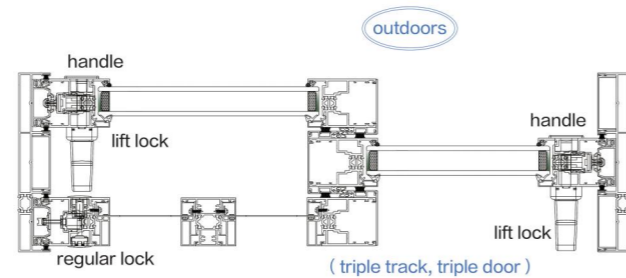
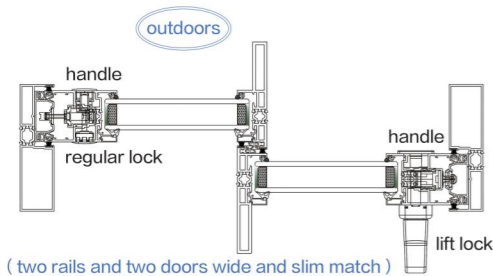
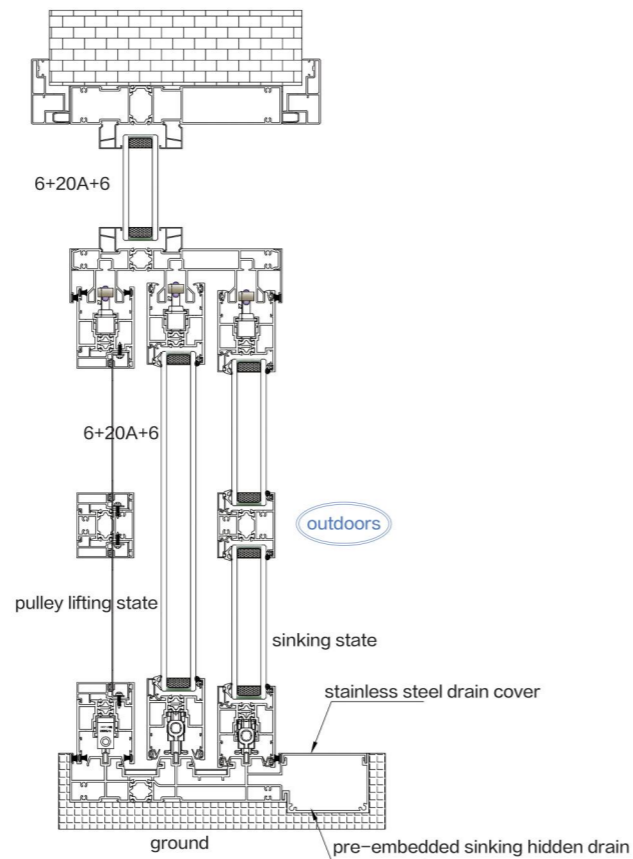

> 130+195 Non-Thermal Break Profiles

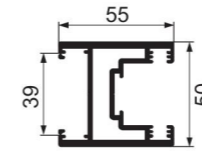

JNW-A-035
55 vertical door frame
Weight : 1.82 kg/m

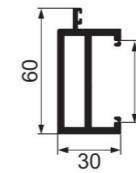

JNW-A-041
30 slim vertical door frame
Weight : 1.40 kg/m

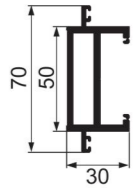

JNW-A-044
30 slim double vertical door frame with hook
Weight : 1.35 kg/m



JNW-A-036
55 single vertical door frame with hook
Weight : 0.43 kg/m

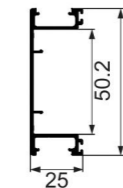

JNW-A-037
55 double vertical door frame with hook
Weight : 0.65 kg/m

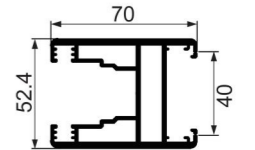

JNW-TS70
70 lifting vertical door frame
Weight : 2.26 kg/m

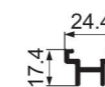

JNW-TS71
elevation add-on material
Weight : 0.30 kg/m

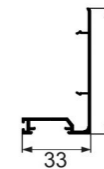

JNW-A-027
70 single vertical door frame with hook
Weight : 0.44 kg/m

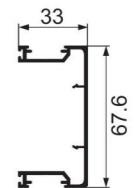

JNW-A-028
70 double vertical door frame with hook
Weight : 0.66 kg/m

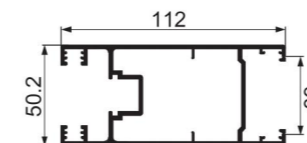

JNW-A-005
112 vertical door frame
Weight : 1.92 kg/m

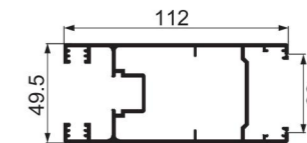

JNW-A-006
112 vertical door frame
Weight : 2.27 kg/m

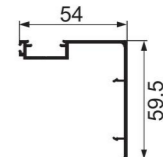

JNW-A-031
112 single vertical door frame with hook
Weight : 0.53 kg/m

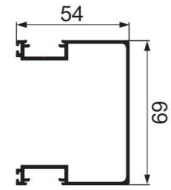

JNW-A-032

112 double vertical door frame with hook
Weight : 0.83 kg/m

► **Automatic Profiles**

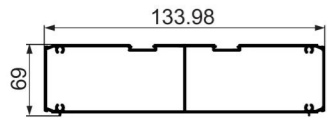

JNW-XT861

intelligent three-rail top rail
Weight : 2.35 kg/m

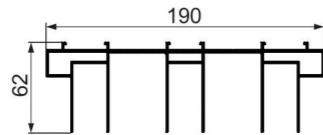

JNW-XT862

intelligent three-rail additional rail
Weight : 3.23 kg/m

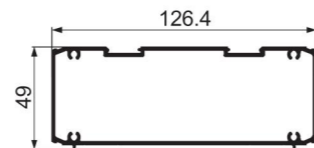

JNW-XT863

intelligent two-rail top rail
Weight : 1.63 kg/m

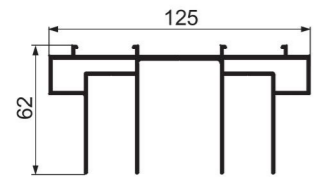

JNW-XT864

intelligent two-rail additional rail
Weight : 2.18 kg/m

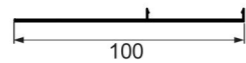

JNW-XT860

intelligent top rail cover
Weight : 0.50 kg/m

► **Two Track Profile**

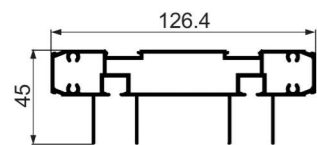

JNW-A-008

two rails top rail
Weight : 2.07 kg/m

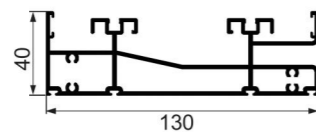

JNW-A-038

two rails hidden drain bottom rail
Weight : 1.68 kg/m

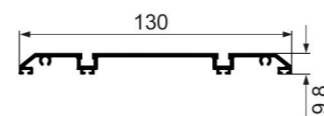

JNW-A-009

two rails flat rail
Weight : 0.89 kg/m

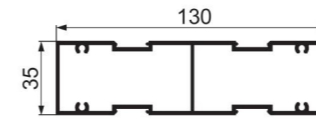

JNW-A-014

two rails central column
Weight : 1.77 kg/m

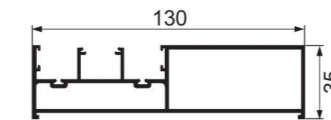

JNW-A-011

two rail side seal
Weight : 1.80 kg/m

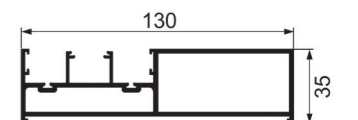

JNW-A-033

two rail side seal 2.0
Weight : 2.13 kg/m

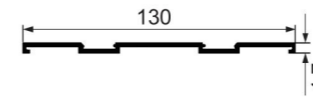

JNW-A-012

two rail side seal cover plate
Weight : 0.74 kg/m

► **Triple Track Profiles**

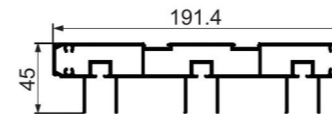

JNW-A-019

three-rail top rail
Weight : 3.04 kg/m

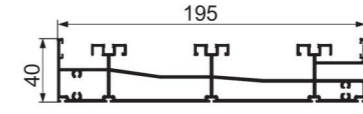

JNW-A-043

three-rail hidden drain bottom rail
Weight : 3.19 kg/m

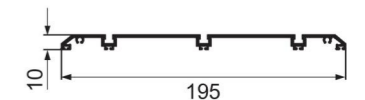

JNW-A-020

three-rail flat rail
Weight : 1.28 kg/m

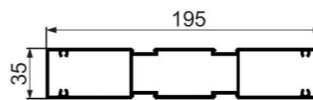

JNW-A-025

three-rail center column
Weight : 2.58 kg/m

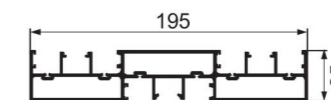

JNW-A-023

three-rail side seal
Weight : 3.09 kg/m

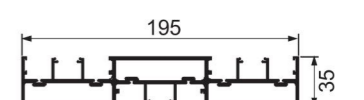

JNW-A-034

three-rail side seal 2.0
Weight : 3.52 kg/m

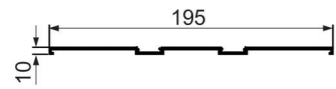

JNW-A-024

three-rail side seal cover
Weight : 1.05 kg/m

► **Universal Profiles**

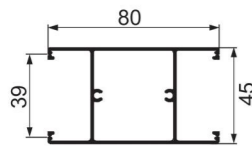

JNW-A-007

mesh center cross
Weight : 0.99 kg/m

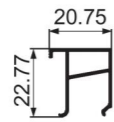

JNW-XT1080F

fixing glass clip
Weight : 0.18 kg/m

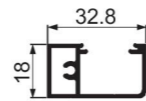

NW-A-030

screen frame
Weight : 0.34 kg/m

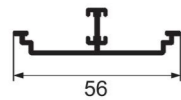

JNW-A-039

inner bottom track frame
Weight : 0.37 kg/m

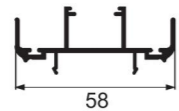

JNW-A-017

closing
Weight : 0.53 kg/m

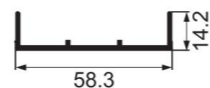

JNW-A-040

bottom rail cover plate
Weight : 0.32 kg/m

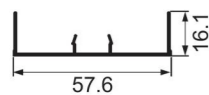

JNW-A-053

side sealing cover platet
Weight : 0.28 kg/m

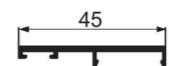

JNW-A-013

top rail cover plate
Weight : 0.25 kg/m

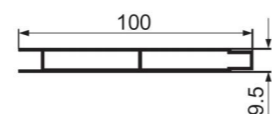

D-A470

100 buckle platet
Weight : 0.538 kg/m

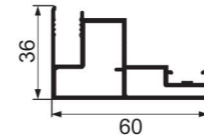

JNW-A-042

60 bale cover
Weight : 0.81 kg/m

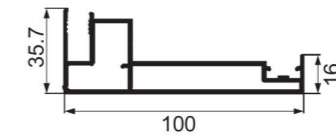

JNW-A-018

100 bale cover
Weight : 1.11 kg/m

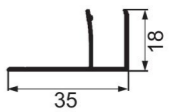

JNW-A-016

f groove
Weight : 0.19 kg/m

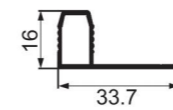

JNW-A-015

p-strip
Weight : 0.18 kg/m

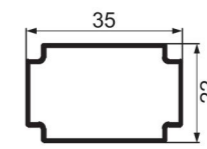

M949

35x22 grid strip
Weight : 0.294 kg/m

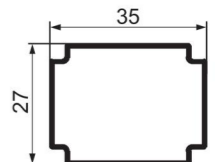

GT-061

35x27 grid strip
Weight : 0.30 kg/m

► **Two Track Assembly Diagram**

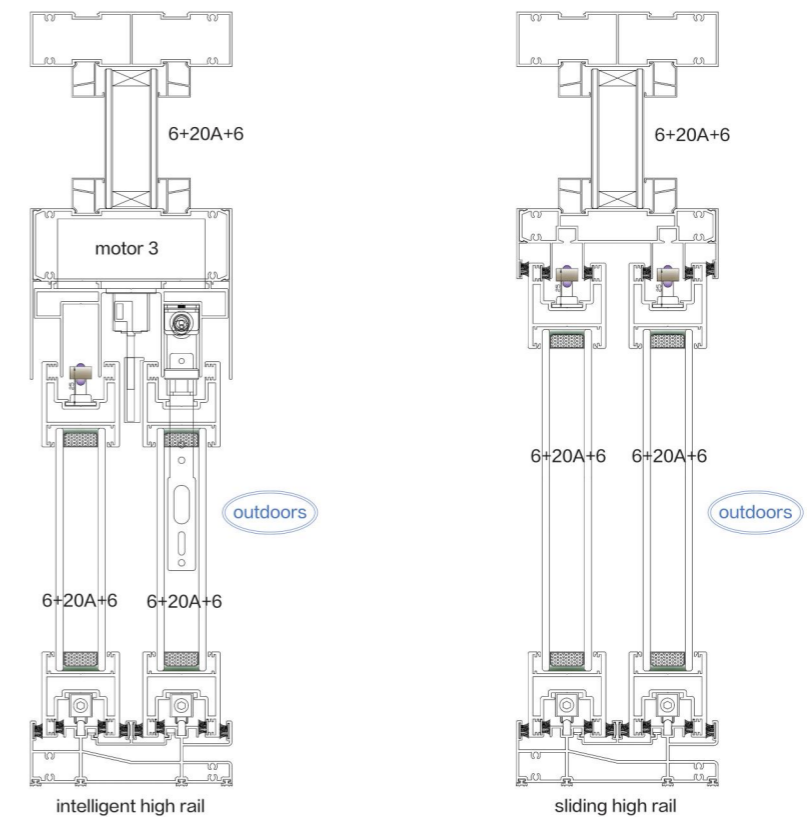

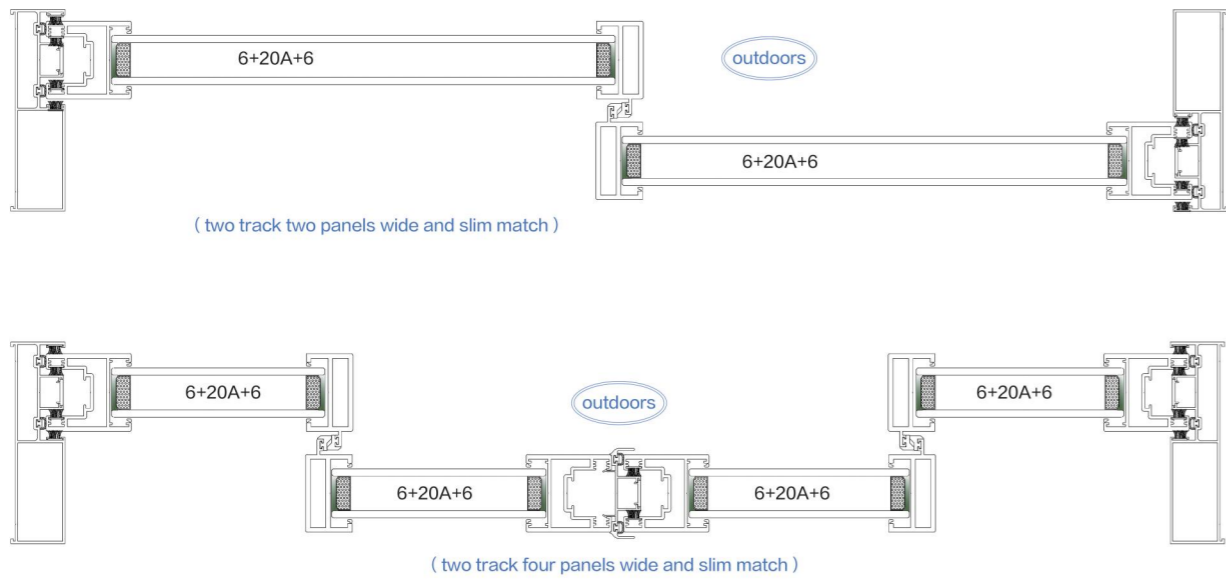

▶ Triple Track Assembly Diagram

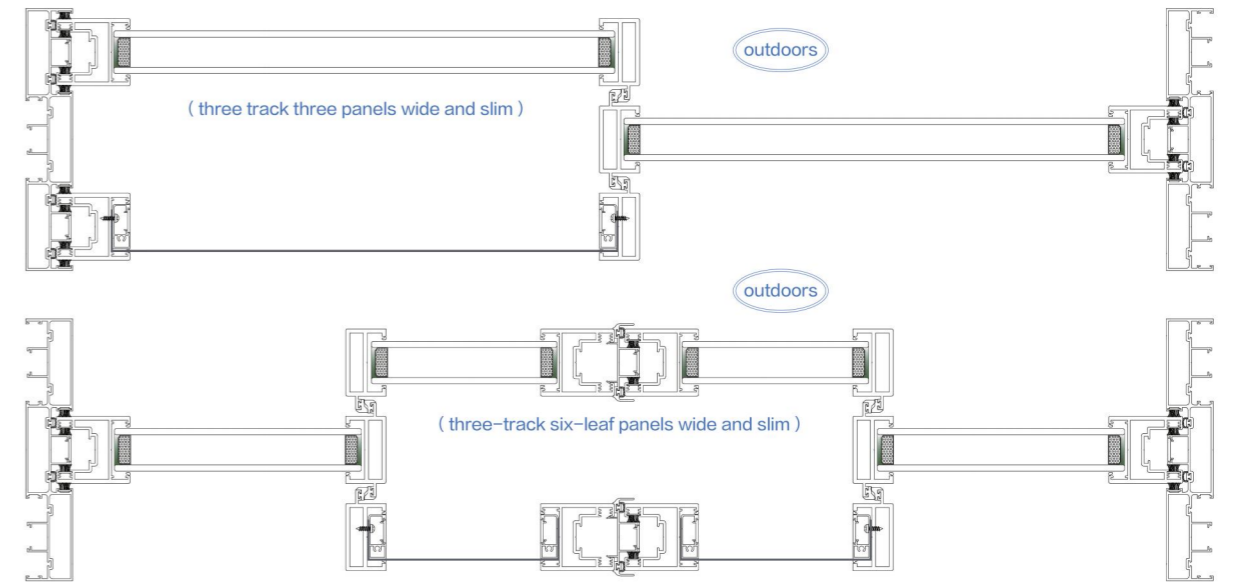
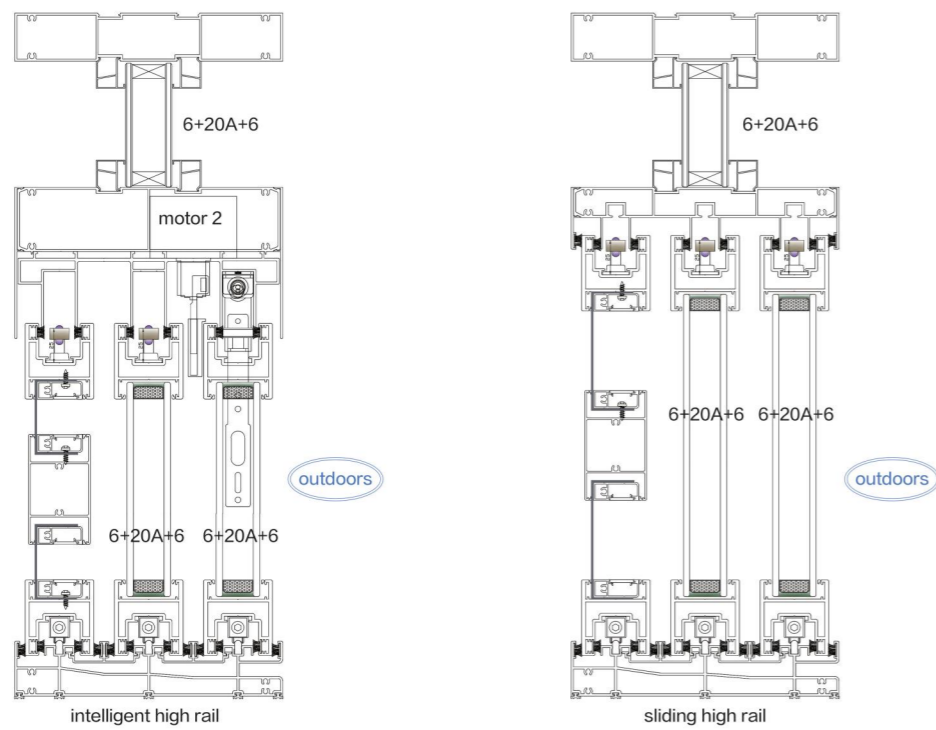

▶ Accessories



glass fan corner code (20.6*11.4)

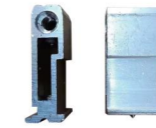

central column corner code (11.3*20.6)



stainless steel dust-proof strip for bottom rail of thermal break heavy-duty door



pre-built dust-proof strip for heavy-duty door(9*78)



70 lifting hardware with key 170kg load capacity



55 special lock metal gray (without key, left)



zinc alloy bumpers



195 heavy-duty door special top wheel (90/102/112 special upper wheel 28.5 high)



thermal break heavy door high track composite steel wheel four bottom wheels (15 * 27)

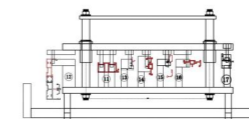

thermal break heavy door do sealing balcony sliding window mold (7 head)

128 Floating Sliding Window >>>



Product Features :

- ① Resistant to wind force 12, very good sealing
- ② Superior drainage system
- ③ Maximum span 7.5 metres
- ④ Hidden track, easy to push and pull, easy to clean

▶ Two Track Profile

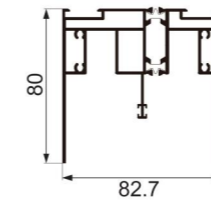

JNW-CT1487F
two-track suspended upper rail
Weight : 2.32 kg/m

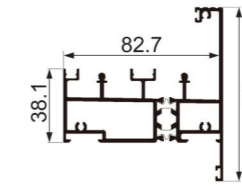

JNW-CT1459F
two-track suspended bottom rail
Weight : 2.29 kg/m

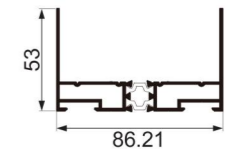

JNW-CT1416F
two rail side seal
Weight : 1.34 kg/m

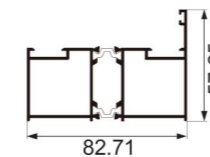

JNW-CT1420F
two-track side frame transform
Weight : 1.40 kg/m

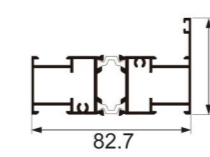

JNW-CT1343E
two tracks fixed up and down
Weight : 1.49 kg/m

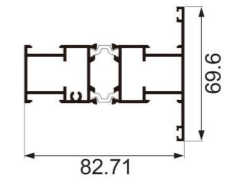

JNW-CT1343G
two rail inner frame
Weight : 1.54 kg/m

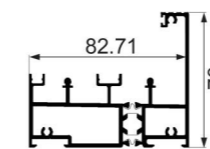

JNW-CT1676F
two-track suspended bottom rail(landing)
Weight : 2.19 kg/m

▶ Triple Track Profiles

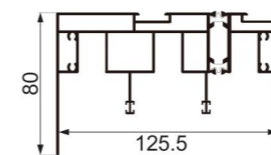

JNW-CT1485F
three-track suspended upper rail
Weight : 3.04 kg/m

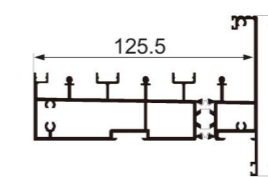

JNW-CT1460F
three-track suspended bottom rail
Weight : 3.07 kg/m

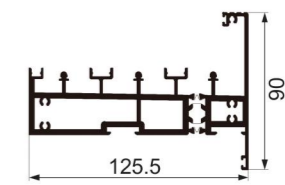

JNW-CT1708F
3.0 three-track suspended bottom rail
Weight : 3.87 kg/m



JNW-CT1417F

three rail side seal
Weight : 1.70 kg/m

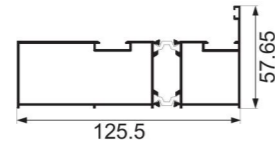

JNW-CT1418F

three-track side frame transform
Weight : 1.77 kg/m

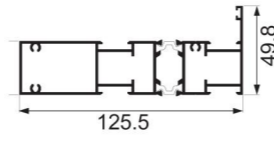

JNW-CT1329F

three tracks fixed up and down
Weight : 1.94 kg/m

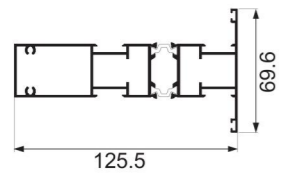

JNW-CT1347F

three track inner frame
Weight : 1.99 kg/m

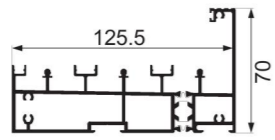

JNW-CT1458F

three-track suspended bottom rail(landing)
Weight : 2.97 kg/m

► **Five Track Profiles**

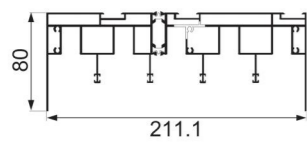

JNW-CT1554F

five-track suspended upper rail
Weight : 4.57 kg/m

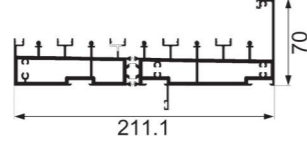

JNW-CT1552F

five-track suspended bottom rail
Weight : 5.85 kg/m

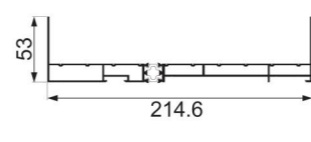

JNW-CT1548F

five-track side frame
Weight : 2.50 kg/m

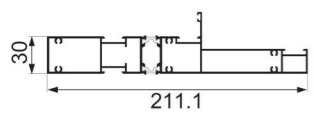

JNW-CT1555F

five tracks fixed up and down
Weight : 2.75 kg/m

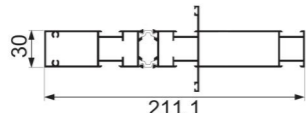

JNW-CT1546F

five tracks central column
Weight : 2.98 kg/m

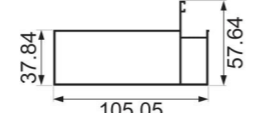

JNW-XT1545

five-track side frame transform outside
Weight : 1.24 kg/m

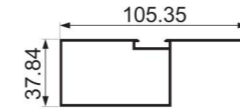

JNW-XT1551

five-track side frame transform inside
Weight : 1.05 kg/m

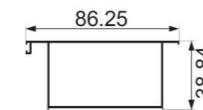

JNW-XT1547

five-track side frame two covers
Weight : 0.70 kg/m

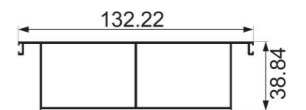

JNW-XT1549

five-track side frame three covers
Weight : 1.10 kg/m

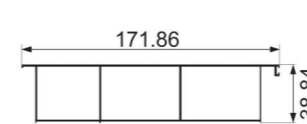

JNW-XT1550

five-track side frame four covers
Weight : 1.44 kg/m

► **Universal Profiles**

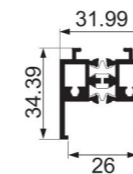

JNW-CT1461F

upper door frame
Weight : 0.93 kg/m

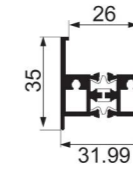

JNW-CT1462F

bottom door frame
Weight : 0.91 kg/m

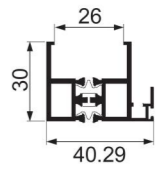

JNW-CT1325F

single vertical door frame with hook
Weight : 0.85 kg/m

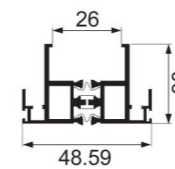

JNW-CT1325G

double vertical door frame with hook
Weight : 0.91 kg/m

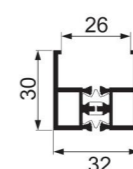

JNW-CT1324F

hidden door frame
Weight : 0.79 kg/m

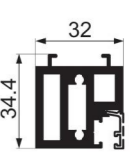

JNW-XT1463

mesh door upper frame
Weight : 1.35 kg/m

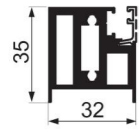

JNW-XT1464
mesh door bottom frame
Weight : 1.30 kg/m

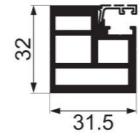

JNW-XT1465F
hidden mesh door
Weight : 1.20 kg/m

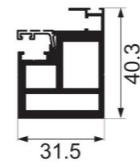

JNW-XT1466F
mesh door with hook
Weight : 1.17 kg/m

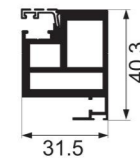

JNW-XT1671
outside mesh door with hook
Weight : 1.24 kg/m

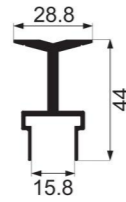

JNW-XT1469
suspended track
Weight : 0.70 kg/m



JNW-XT1672
suspended track with woolen strips
Weight : 0.70 kg/m

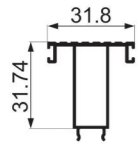

JNW-XT1468
bottom double side frame cover
Weight : 0.38 kg/m

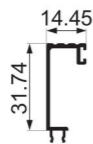

JNW-XT1467
bottom single side frame cover
Weight : 0.23 kg/m

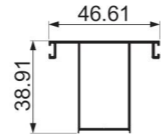

JNW-XT1331
side frame double cover
Weight : 0.46 kg/m

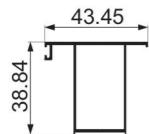

JNW-XT1332F
side frame single cover
Weight : 0.41 kg/m

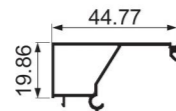

JNW-XT1342
indoor square clip
Weight : 0.30 kg/m

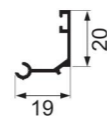

GD-131
outdoor clip
Weight : 0.16 kg/m

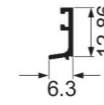

JNW-XT1355F
mesh door clip
Weight : 0.07 kg/m

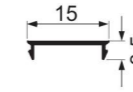

GD-014
universal slot cover
Weight : 0.05 kg/m

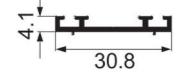

JNW-XT1333
side frame anti-collision strips
Weight : 0.15 kg/m

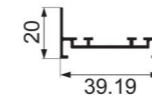

JNW-XT1334
closing
Weight : 0.31 kg/m

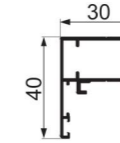

JNW-XT389
clothes drying guardrail frame
Weight : 0.50 kg/m

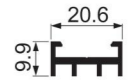

JNW-XT263
additional european standard slot
Weight : 0.20 kg/m

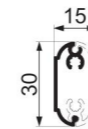

JNW-XT051F
two-color grid
Weight : 0.40 kg/m

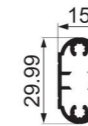

GD-036A
integrated grid strip
Weight : 0.37 kg/m

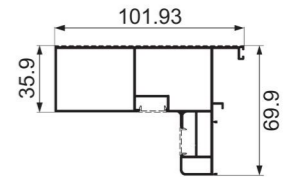

JNW-XT1470
handrail
Weight : 1.51 kg/m

► Automatic Profiles

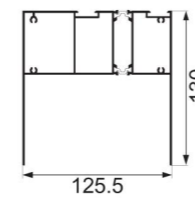

JNW-CT1584F
128 intelligent top rail
Weight : 2.95 kg/m

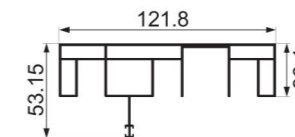

JNW-XT1586
suspended window intelligent upper track additional track
Weight : 1.90 kg/m

► Assembly Diagram

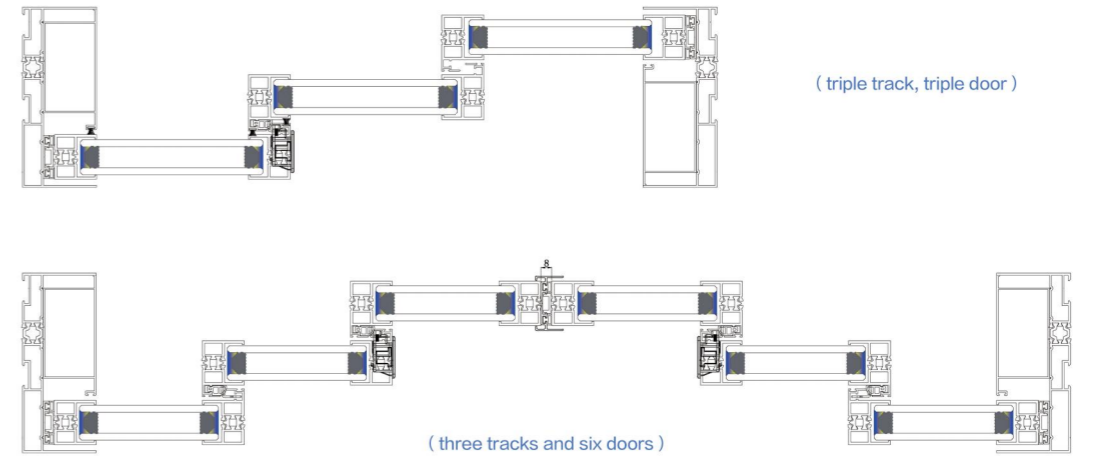
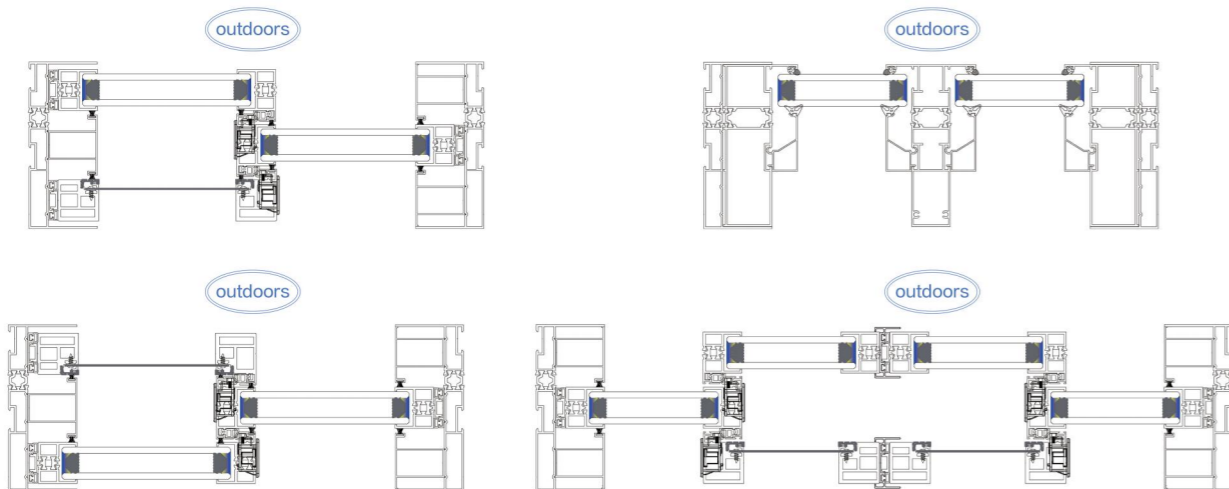
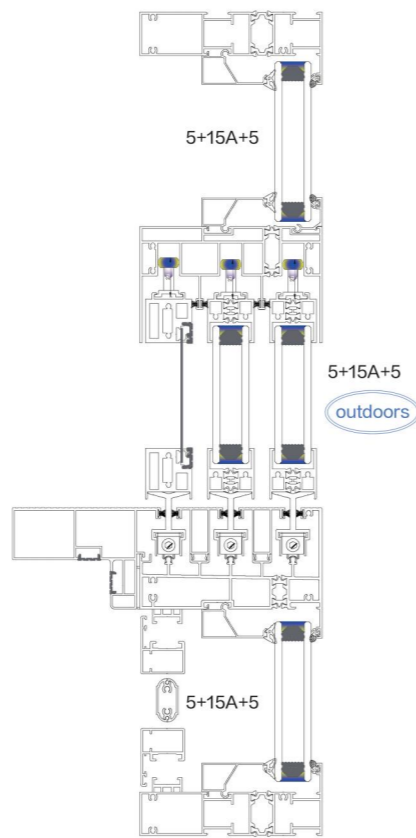

► Accessories



120 sliding window drying guardrail pin code (21*14.7)



125 thermal break scenery window center column code (JM-18.55ZH)



128 suspended window special self-tightening 23 high upper wheel



drilling sealant



125 thermal break scenery window special lock black (left) nice style



scenery sliding window 150kg load-bearing rubyfour wheels



scenery sliding window special self-tightening ruby high upper wheel



3MM semicircular stainless steel rail

130 Lift Sliding Window >>>

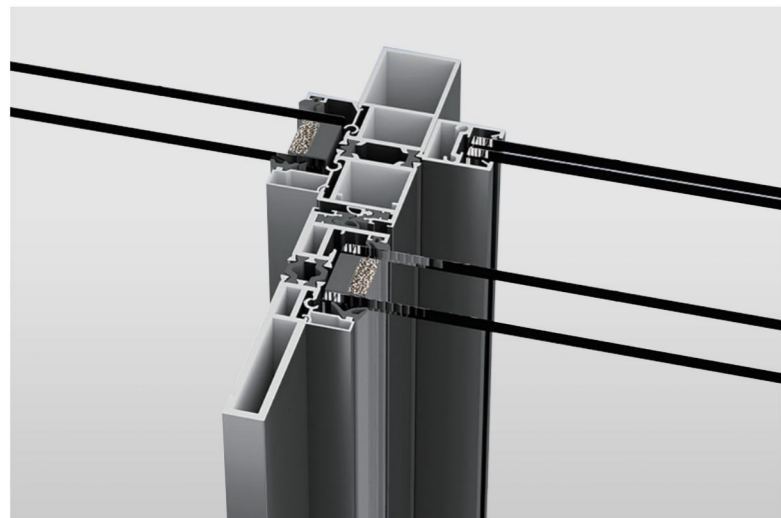

Product Features :

- ① Lifting sliding for better sealing performance
- ② Positioned at will, easy to adjust the ventilation area
- ③ Sound and heat insulation, energy efficient

Lifting Profiles

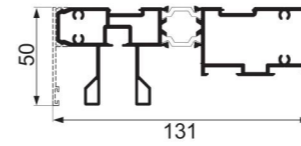

JNW-GD925F
lifting top rails
Weight : 2.62 kg/m

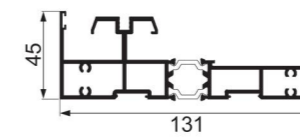

JNW-GD919F
lifting bottom rail
Weight : 2.48 kg/m

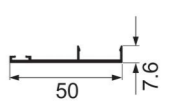

JNW-XT917
lift the top rail cover plate
Weight : 0.23 kg/m

130 Lift Sliding Window

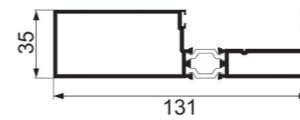

JNW-BF923F
side frame
Weight : 1.93 kg/m

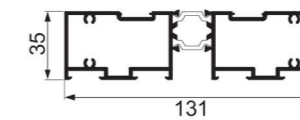

JNW-BF925F
two-fixed, two-activated side seals
Weight : 2.4 kg/m

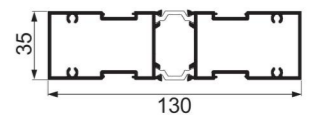

JNW-ZT938F
center column
Weight : 2.0 kg/m

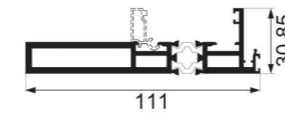

JNW-TS1121F
inner strengthen door frame
Weight : 2.11 kg/m

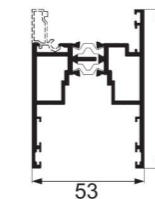

JNW-TS911F
75 lifting door
Weight : 1.79 kg/m

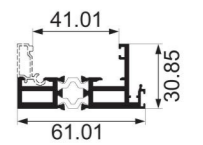

JNW-TS929F
inside slim vertical door frame
Weight : 1.23 kg/m

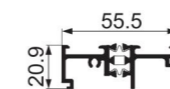

JNW-CT1564F
drainage conversion for bottom rails
Weight : 0.81 kg/m

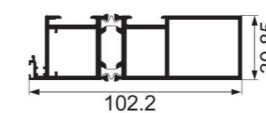

JNW-CT1566F
thermal break reinforced hook center frame
Weight : 1.94 kg/m

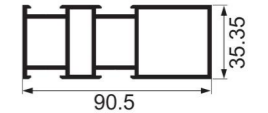

JNW-XT1022
two-way reinforced center frame
Weight : 1.80 kg/m

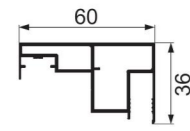

JNW-A-042
60 packs
Weight : 0.77 kg/m

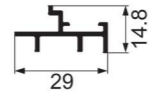

JNW-XT934F
sinking sealing aluminum strip
Weight : 0.21 kg/m

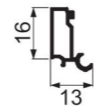

JNW-XT913D
door clip
Weight : 0.15 kg/m

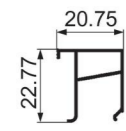

JNW-XT1080F
fixing glass door clip
Weight : 0.18 kg/m

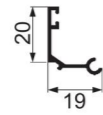

GD-131
outdoor clip
Weight : 0.16 kg/m

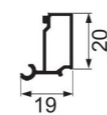

JNW-XT926F
indoor cover
Weight : 0.19 kg/m

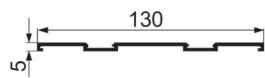

JNW-A-012
fixing glass conversion cover plate
Weight : 0.74 kg/m

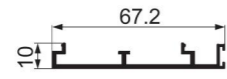

JNW-XT933
treadle cover
Weight : 0.44 kg/m

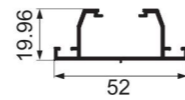

JNW-XT924F
side closure slots
Weight : 0.44 kg/m

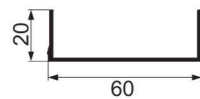

JNW-XT951
side sealing cover plate
Weight : 0.37 kg/m

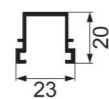

JNW-XT914
75 door slot
Weight : 0.23 kg/m

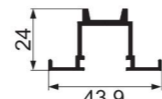

JNW-XT1008
intelligent lock slot
Weight : 0.42 kg/m

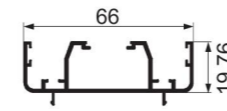

JNW-XT931F
closing
Weight : 0.66 kg/m

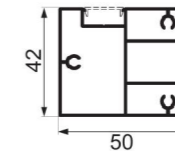

JNW-XT240
glass guardrail
Weight : 0.70 kg/m

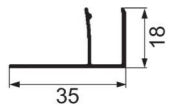

JNW-A-016
f groove
Weight : 0.18 kg/m

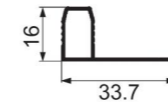

JNW-A-015
p-strip
Weight : 0.18 kg/m

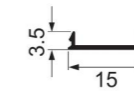

GD-014
universal slot cover
Weight : 0.05 kg/m

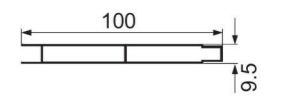

D-A470
100 buckle plate
Weight : 0.49 kg/m



JNW-XT927
hooked center frame
Weight : 1.31 kg/m



JNW-XT1023
reinforced hook center frame
Weight : 1.81 kg/m

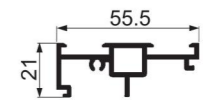

JNW-XT956
bottom rail drainage conversion
Weight : 1.31 kg/m

► Automatic Profiles

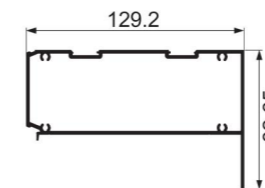

JNW-XT1185
intelligent top rail
Weight : 2.16 kg/m

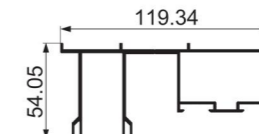

JNW-XT1186
intelligent top rail additional groove
Weight : 1.78 kg/m

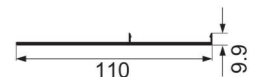

JNW-XT860
intelligent top rail cover
Weight : 0.50 kg/m

► Assembly Diagram

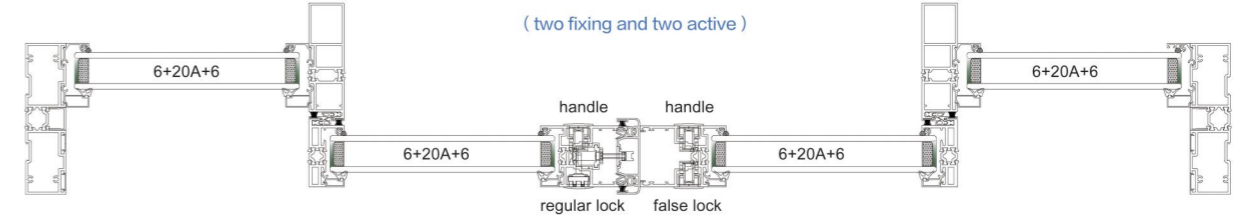
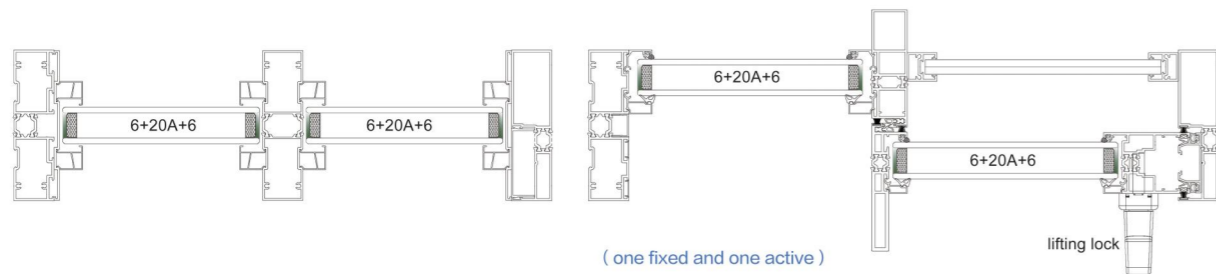
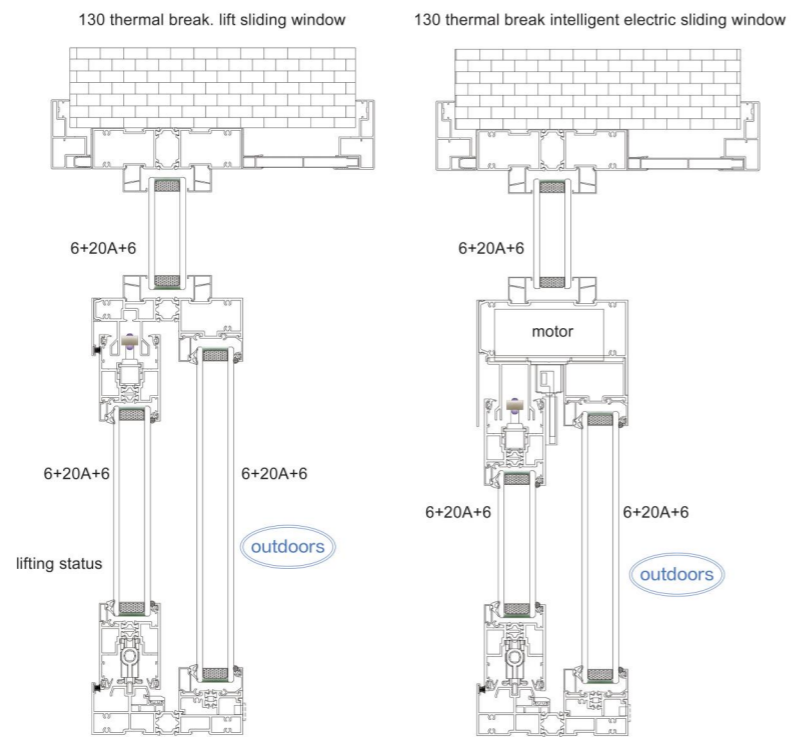

► Accessories



glass fan corner code (20.6*11.4)

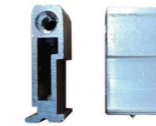

central column corner code (11.3*20.6)



stainless steel dust-proof strip for bottom rail of thermal break heavy-duty door



thermal break heavy door high track composite steel wheel four bottom wheels (15 * 27)



70 lifting hardware with key 170kg load capacity



55 special lock metal gray (without key, left)



zinc alloy bumpers



195 heavy-duty door special top wheel (90/102/112 special upper wheel 28.5 high)

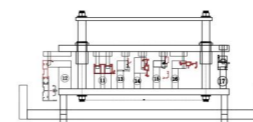

thermal break heavy door do sealing balcony sliding window mold (7 head)

120-1# Slim Casement Window >>>



Product Features :

- ① Sash, glass fan can be done with the same type of handle
- ② Can do outside opening fan, very narrow frame
- ③ Glass: 5+20A+5, Aluminum alloy handle
- ④ Sash can be made of adamantine and HD Sash

>>> EXTERIOR CASEMENT SYSTEM



▶ 120-1# Slim Casement Window

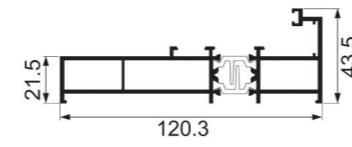

JNW-CT1189F

out frame
Weight : 1.89 kg/m

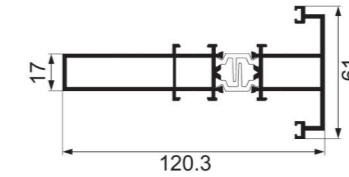

JNW-CT1190F

center column
Weight : 2.12 kg/m

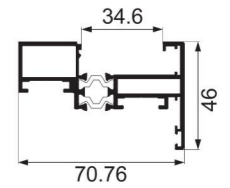

JNW-CT1214F

glass sash A
Weight : 1.34 kg/m

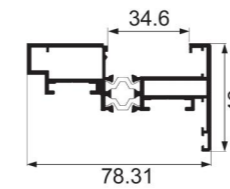

JNW-CT1221F

glass sash B
Weight : 1.43 kg/m

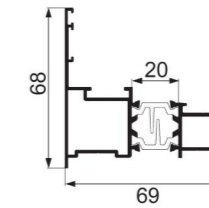

JNW-CT1191F

subframe A
Weight : 1.2 kg/m

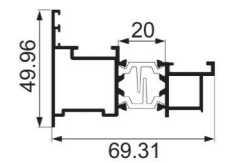

JNW-CT1222F

subframe B
Weight : 1.15 kg/m

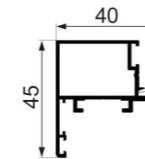

JNW-XT1192

screen sash
Weight : 0.64 kg/m

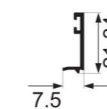

JNW-XT518

mesh door clip
Weight : 0.12 kg/m



JNW-XT1193

square clip
Weight : 0.24 kg/m

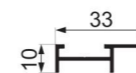

JNW-XT1194

screen sash subframe
Weight : 0.17 kg/m

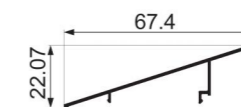

JNW-XT11212

skew clip
Weight : 0.29 kg/m

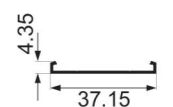

JNW-XT1213

slot for sash clip
Weight : 0.12 kg/m

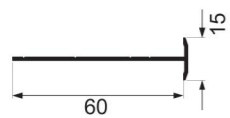

JNW-XT208
frame splicing strip
Weight : 0.28 kg/m

▶ **Assembly Diagram**

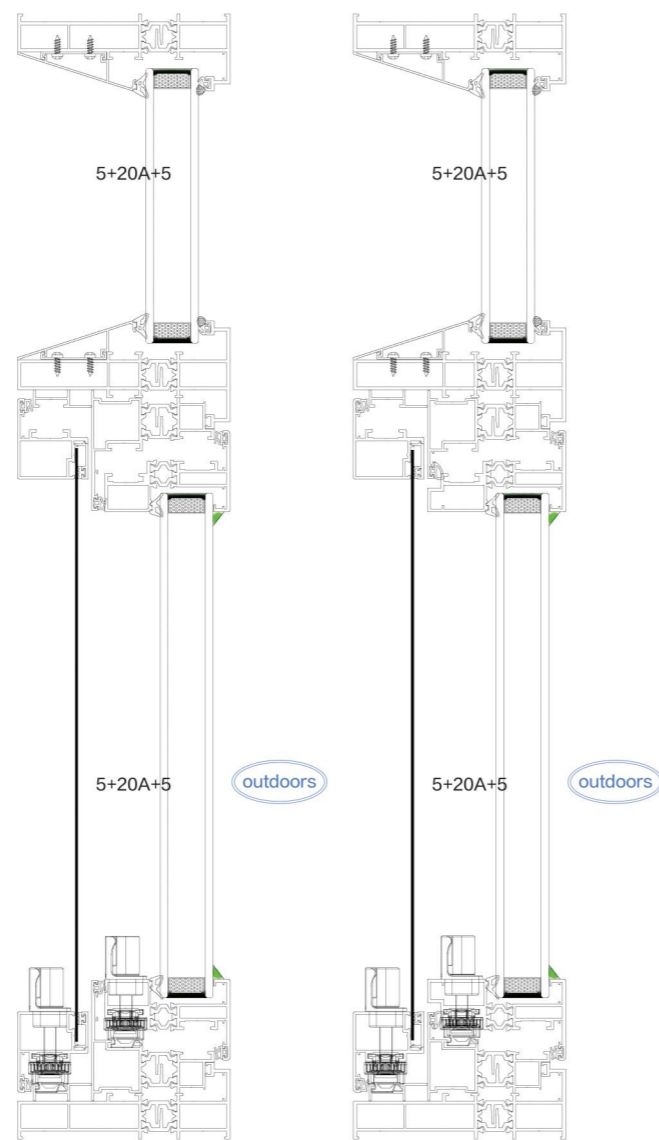

▶ **Accessories**

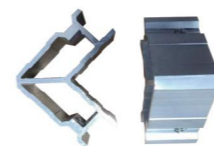

120 slim outer frame color injection corner code (26.2*13.2)



120 slim center column inner color injection corner code (jm16zh*13.2)



side lock (silver) left



side lock (silver) left



large center column machine (without blade)



13.5*1.0*1.2 stainless steel injection molding group corner piece

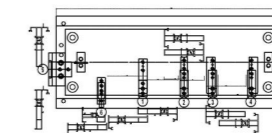

slim frame center column mold 6 molds

110-3# Slim Casement Window



Product Features :

- ① Profile not only for window but also for door
- ② Glass:5+20A+5
- ③ Can do external opening, very narrow frame
- ④ Single fan maximum: 2.2m * 1.0m

110-3# Slim Casement Window

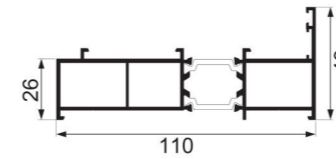

JNW-BK812A
injection molded frame
Weight : 1.69 kg/m

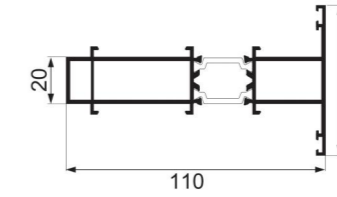

JNW-ZH813A
injection molded center post
Weight : 1.82 kg/m

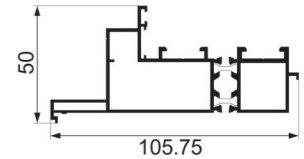

DZ-CT797F
slim subframe
Weight : 1.55 kg/m

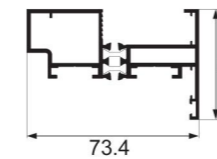

DZ-CT795F
slim glass sash
Weight : 1.36 kg/m

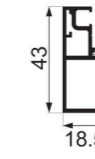

DZ-793
slim screen sash
Weight : 0.59 kg/m



DZ-794
mesh door clip
Weight : 0.09 kg/m



JNW-XT1230
guardrail frame
Weight : 0.12 kg/m



JNW-XT1231
latticework
Weight : 0.20 kg/m

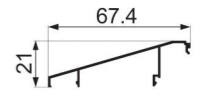

JNW-XT772
beveled edge clip
Weight : 0.32 kg/m

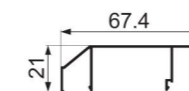

JNW-XT778
diamond clip
Weight : 0.40 kg/m

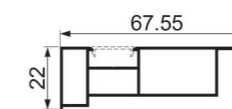

JNW-XT780
bent clip
Weight : 0.50 kg/m

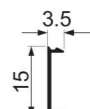

GD-014
universal slot cover
Weight : 0.05 kg/m

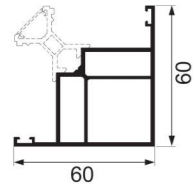

JNW-XT1009
outside the 90° slim corner
Weight : 1.14 kg/m



JNW-XT1010
inside a 90° slim corner
Weight : 0.38 kg/m

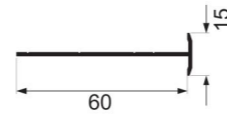

JNW-XT208
frame splicing strip
Weight : 0.28 kg/m

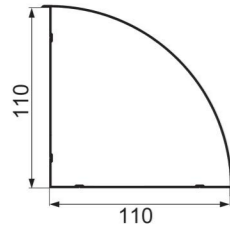

ZJ110A
110 corners – 90°
Weight : 1.42 kg/m

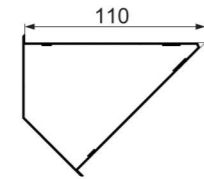

ZJ110B
110 degree corner – 135°
Weight : 1.13 kg/m

► **Assembly Diagram**

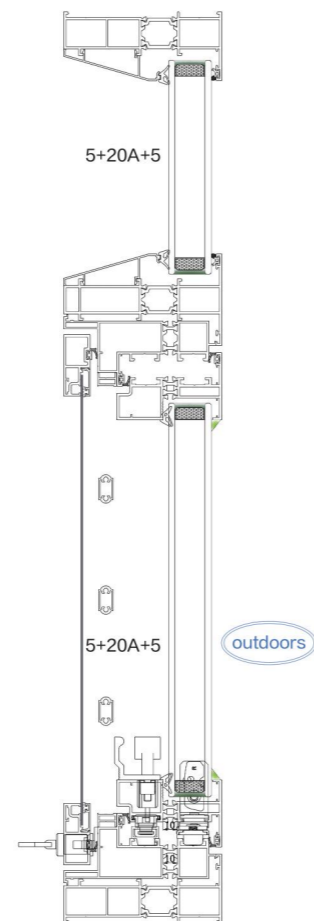

110 #3 Outside& Inside Opening Window >>>



Product Features :

- ① Glass fan opening options: inward opening, outward opening, double inward opening, casement, micro-ventilation.
- ② Profile not only for window but also for door
- ③ Glass: 5+20A+5

► 110#3 Outside Opening Window

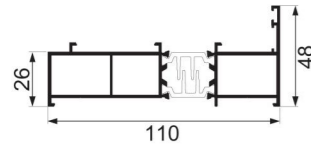

JNW-BK812A
injection molded frame
Weight : 1.69 kg/m

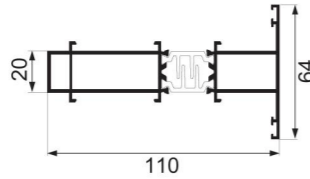

JNW-ZH813A
injection molded center post
Weight : 1.82 kg/m

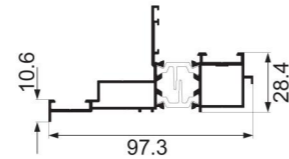

JNW-FK773A
subframe
Weight : 1.29 kg/m

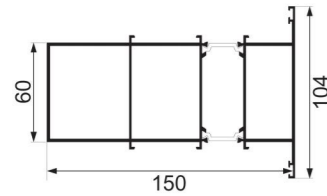

JNW-ZT802
strengthen inner frame
Weight : 3.26 kg/m

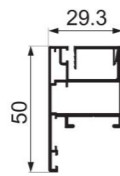

JNW-1007
50 screen sash
Weight : 0.62 kg/m



JNW-1011
sash cover
Weight : 0.09 kg/m

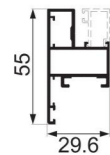

JNW-XT770
sash without folded edge
Weight : 0.7 kg/m



JNW-XT769
sash square crimp
Weight : 0.16 kg/m

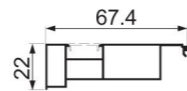

JNW-XT780
bent clip
Weight : 0.5 kg/m

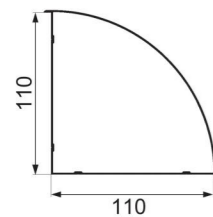

ZJ110A
90 degree corner
Weight : 1.35 kg/m

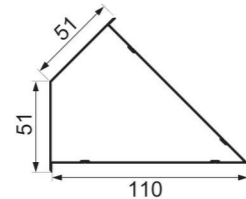

ZJ110B
135 degree corner
Weight : 1.08 kg/m

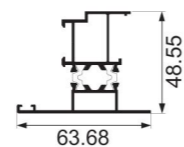

HC235B
center frame for glass fans
Weight : 1.0 kg/m

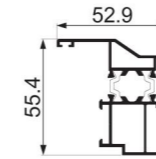

HC110
sash center frame
Weight : 1.0 kg/m

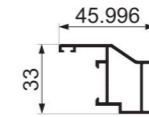

GD-026
sash center frame
Weight : 0.56 kg/m

► 110#3 Inside Opening Window

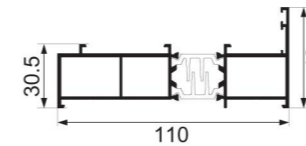

JNW-BK760A
outer frame
Weight : 1.65 kg/m

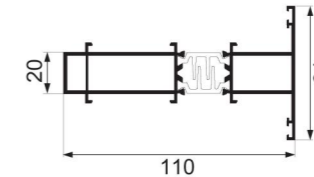

JNW-ZH762A
center column
Weight : 1.78 kg/m

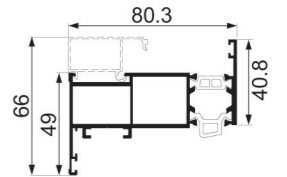

JNW-HC807A
double inside out glass fan
Weight : 1.65 kg/m



JNW-XT816
additional european standard slot
Weight : 0.21 kg/m

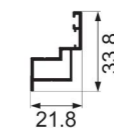

JNW-XT902
screen sash subframe
Weight : 0.3 kg/m

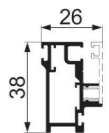

JNW-XT287
double inside opening sash
Weight : 0.6 kg/m

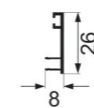

JNW-XT267
mesh door clip
Weight : 0.15 kg/m

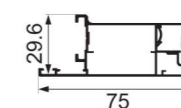

JNW-1006
75 screen sash
Weight : 0.73 kg/m



JNW-1010
75 mesh door clip
Weight : 0.13 kg/m

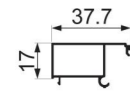

JNW-XT815
clip
Weight : 0.28 kg/m

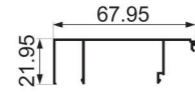

JNW-XT811
square clip
Weight : 0.41 kg/m

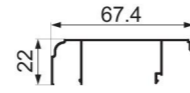

JNW-XT855
round crimp
Weight : 0.4 kg/m

► **Universal Profiles**

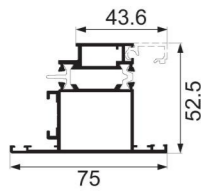

JNW-HC847A
75 new clip glass fan
Weight : 1.39 kg/m

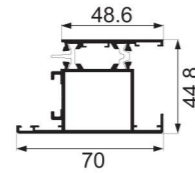

JNW-HC771A
3 glass fan
Weight : 1.31 kg/m

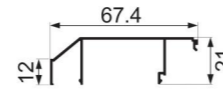

JNW-XT778
diamond clip
Weight : 0.39 kg/m

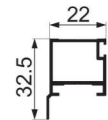

JNW-XT768
guardrail frame
Weight : 0.35 kg/m

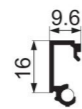

JNW-XT846B
clip
Weight : 0.15 kg/m

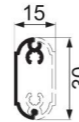

JNW-XT051F
two-color grid
Weight : 0.2 kg/m

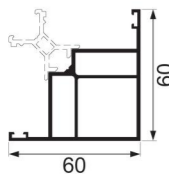

JNW-XT1009
90° slim corner
Weight : 1.14 kg/m

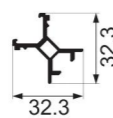

JNW-XT1010
90° slim corner
Weight : 0.38 kg/m

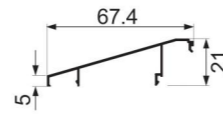

JNW-XT772
subversive 3 clip
Weight : 0.32 kg/m

► **Assembly Diagram**



► **Accessories**

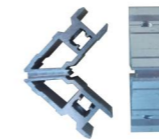

3, 4 sub-frame outside color face pin corner code (18*18.2)



3, 4 hidden row of center column corner code (18.4zh * 16) left



floor drain cover



(germany) rehus hardware silver left



large center column machine (without blade)



no.3 110 center column milling cutter (set of 4 cutters)

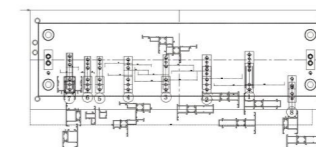

no. 3 and no. 4 corner hole stamping dies (8 heads)

90-1# New Casement Window >>>

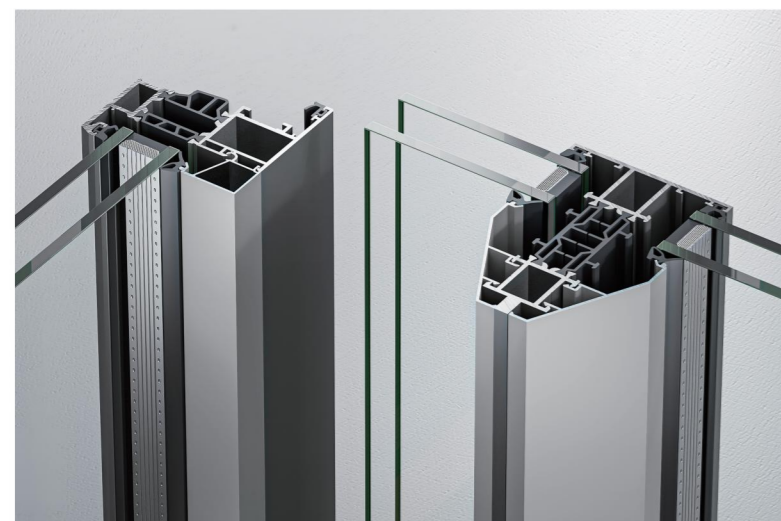

Product Features :

- ① .Multi-cavity structure design, better thermal insulation effect
- ② Efficient airtight and watertight performance, new floor drain type drainage
- ③ Ten kinds of opening programmes, 6 kinds of pressure line optional

>>> EXTERIOR CASEMENT SYSTEM

▶ 65 Medium Narrow Glass Fan Series - Double Inside Opening

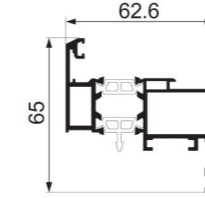

JNW-CT1254E

65 medium narrow double inner open glass sash
Weight : 1.52 kg/m



JNW-XT267

65 medium narrow sash clip
Weight : 0.15 kg/m

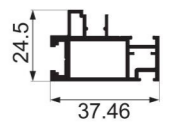

JNW-XT1256F

65 medium narrow sash
Weight : 0.62 kg/m

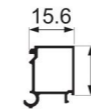

JNW-XT1677

65 glass door double inward open double glass clip
Weight : 0.17 kg/m

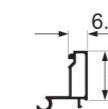

JNW-XT1678

65 double inner open three glass sash double thermal break clip
Weight : 0.15 kg/m

▶ 65 Medium Narrow Glass Fan Series - Single Inside Opening

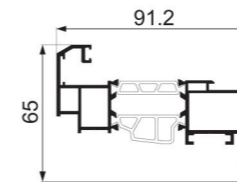

JNW-CT1255F

65 medium narrow single inner open glass sash
Weight : 1.81 kg/m



JNW-XT1676

65 single inner open three glass sash double thermal break clip
Weight : 0.21 kg/m

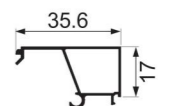

JNW-XT1675

65 single inner open double glass clip
Weight : 0.23 kg/m

▶ 90 Glass Fan Series - Single Outside Opening

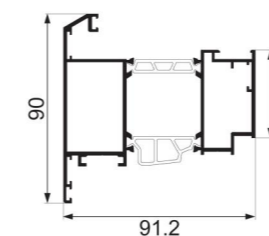

JNW-CT1736F

90 single outward open glass door
Weight : 2.18 kg/m

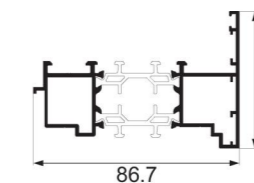

JNW-CT1733F

90 outward open subframe
Weight : 1.5 kg/m

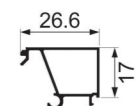

JNW-XT1676

65 single outward open three glass sash double thermal break clip
Weight : 0.21 kg/m

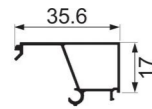

JNW-XT1675

65 single inner open double glass clip
Weight : 0.23 kg/m

► **90 Glass Fan Series - Single Inside Door or Counter Door**

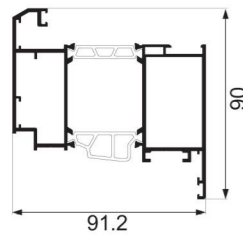

JNW-CT1272F

90 single inward open door
Weight : 2.29 kg/m

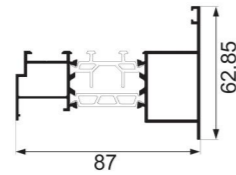

JNW-CT1271F

double door closing
Weight : 1.46 kg/m

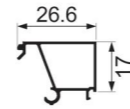

JNW-XT1676

90 three glass sash double thermal break clip
Weight : 0.21 kg/m

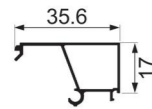

JNW-XT1675

90 double glass clip
Weight : 0.23 kg/m

► **55 Slim Glass Fans Series - Double Inside Opening**

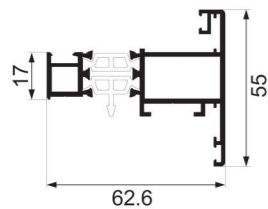

JNW-CT1720F

55 ultra narrow double inner open glass sash
Weight : 1.23 kg/m

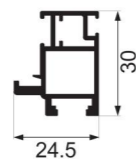

JNW-XT1718

55 ultra narrow double inner open glass sash
Weight : 0.5 kg/m



JNW-XT518

55 ultra narrow double inner open glass sash clip
Weight : 0.15 kg/m

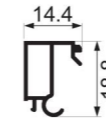

JNW-XT1732F

55 ultra narrow double inner open double glass sash clip
Weight : 0.16 kg/m

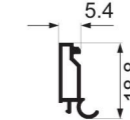

JNW-XT1731F

55 double inner open three glass sash double thermal break clip
Weight : 0.12 kg/m

► **55 Slim Glass Series - Single Opening**

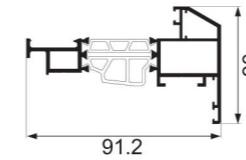

JNW-CT1716F

55 ultra narrow single inner open sash
Weight : 1.48 kg/m

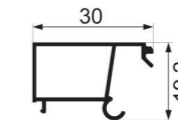

JNW-XT1717F

55 single inner open double glass sash clip
Weight : 0.23 kg/m

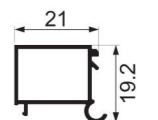

JNW-XT1715F

55 single inner open three glass sash double thermal break clip
Weight : 0.2 kg/m

► **Micro Ventilation Double Casement**

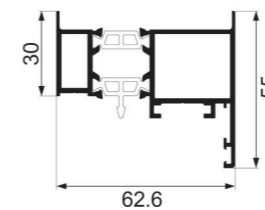

JNW-CT1723F

micro ventilation sash
Weight : 1.3 kg/m

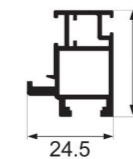

JNW-XT1718

55 ultra narrow double inner open glass sash
Weight : 0.5 kg/m



JNW-XT518

55 ultra narrow double inner open glass sash clip
Weight : 0.15 kg/m

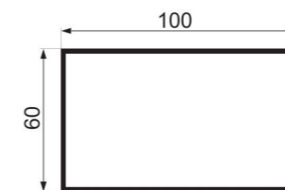

FG100A

micro ventilation square tube
Weight : 1.18 kg/m

▶ Sliding Window

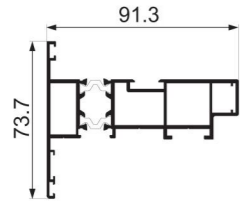

JNW-CT1728F
flat sliding door
Weight : 1.9 kg/m

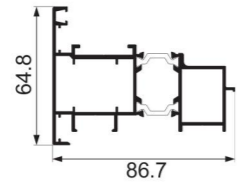

JNW-CT1725F
flat sliding sub-frame
Weight : 1.74 kg/m

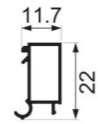

JNW-XT1727
flat sliding double inner glass clip
Weight : 0.18 kg/m

▶ Universal Aluminium Profiles

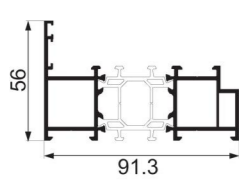

JNW-CT1249D
outer frame
Weight : 1.84 kg/m

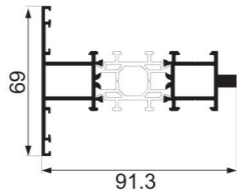

JNW-CT1251D
center column
Weight : 1.87 kg/m

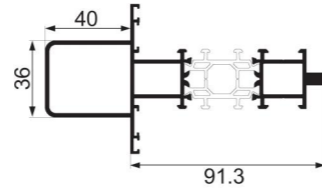

JNW-CT1738F
strengthen center column
Weight : 2.42 kg/m

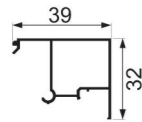

JNW-XT1737F
large glass square clip
Weight : 0.34 kg/m

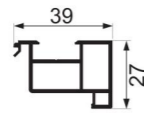

JNW-XT1739
bending clip
Weight : 0.59 kg/m

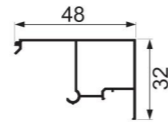

JNW-XT1741F
large glass square clip
Weight : 0.36 kg/m



DZ-014
bending clip screw cover
Weight : 0.05 kg/m

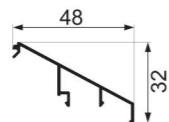

JNW-XT1721
double glass bevel edge clip
Weight : 0.29 kg/m

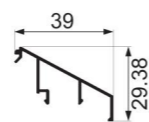

JNW-XT1729
three glass sash double thermal break clip
Weight : 0.27 kg/m

▶ Assembly Diagram

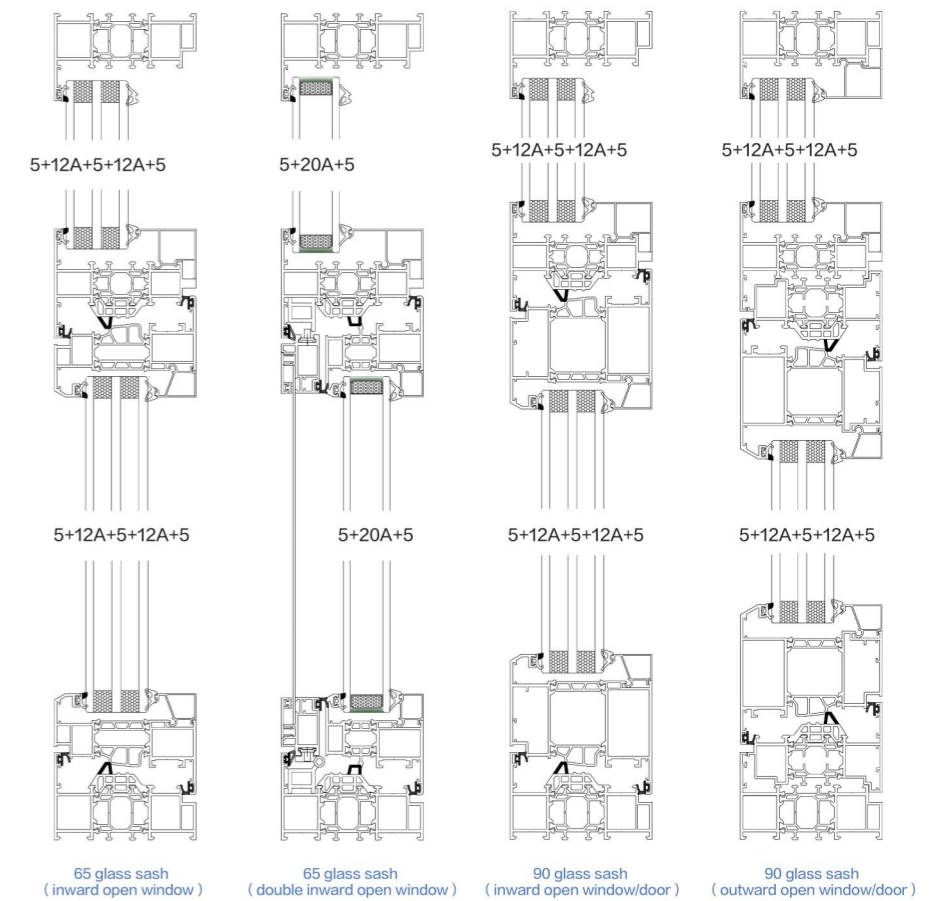
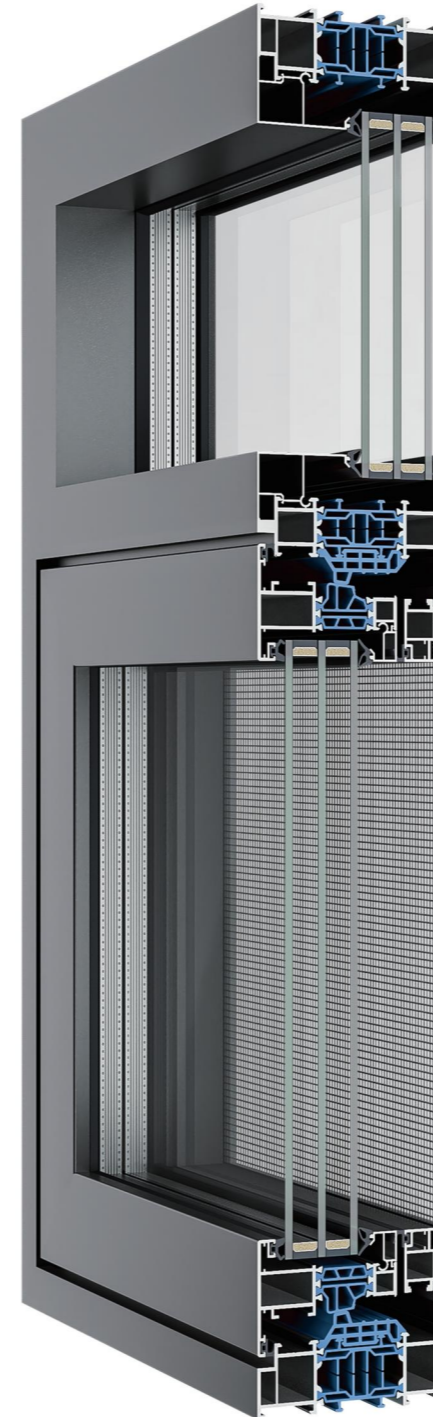

► Assembly Diagram

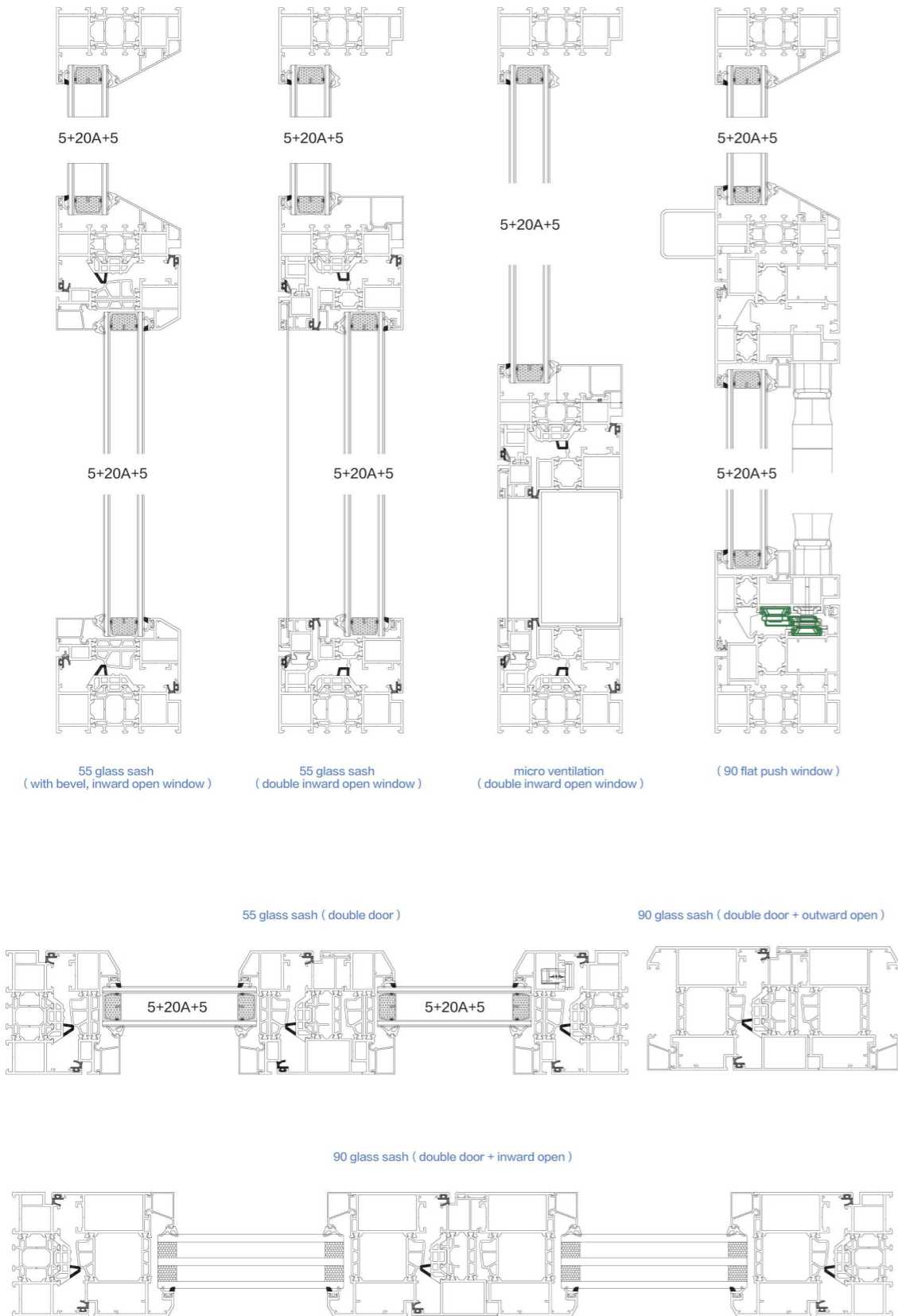

► Accessories

90 system external color corner code (ZJM-2-21.4*21.3)	90 system center column color corner code (JM-P21ZH)	13.5*1.0*1.2 stainless steel injection corner piece	micro ventilation hinge
single inner open adhesive strip (JNW9)	double inner open adhesive strip (JNW10)	flat sliding window adhesive strip	17.5*20 die casting flat sheet
fixed position pad	90 system milling cutter set	swing door hardware (handles, hinges, manual latches)	NICE inward opening and inward tilting hardware (left)
casement window 65 sashes /clip eight molds			

► Threshold Series

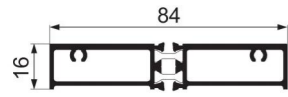

JNW-MK100
100 threshold
Weight : 1.14 kg/m

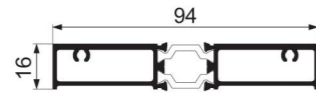

JNW-MK110
110 threshold
Weight : 1.2 kg/m

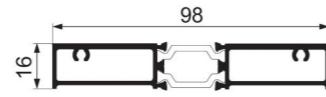

JNW-MK115
115 threshold
Weight : 1.24 kg/m

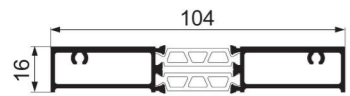

JNW-MK120
120 threshold
Weight : 1.28 kg/m

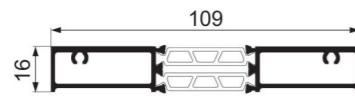

JNW-MK125
125 threshold
Weight : 1.38 kg/m

► Assembly Diagram

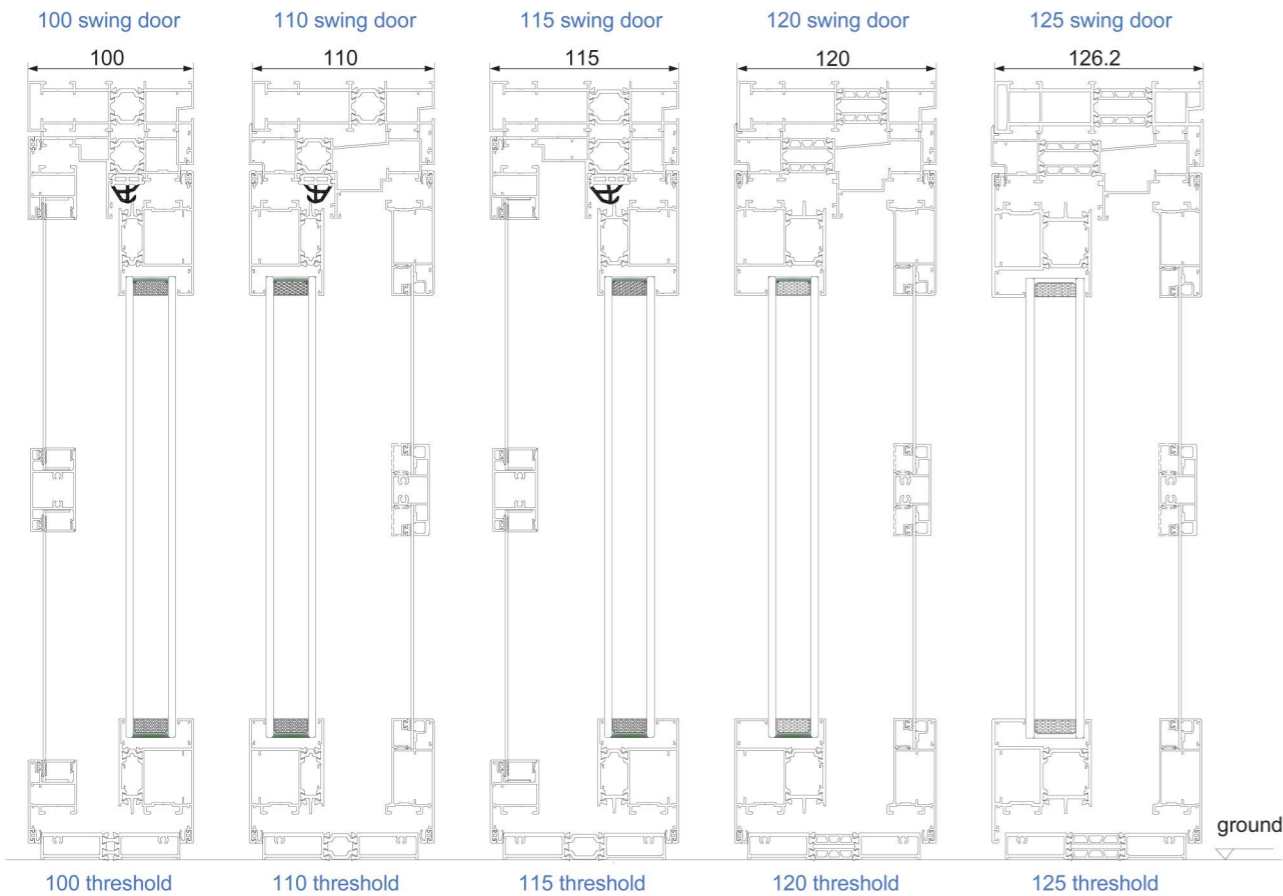

50 Upper Lift Window >>>



Product Features :

- ① Lifting windows provide better lighting and a wider field of vision
- ② Easy installation and removal of window sashes
- ③ Less friction when sliding up and down

► 50 Upper Lift Window

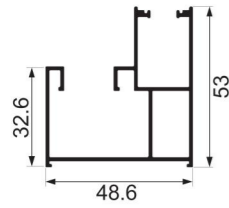

JY-50TS-01A
side frame
Weight : 0.798 kg/m

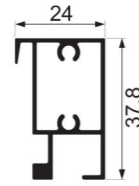

JY-50TS-02
fixed door frame with hook
Weight : 0.493 kg/m

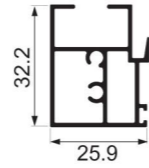

JY-50TS-03
movable door frame with hook
Weight : 0.495 kg/m

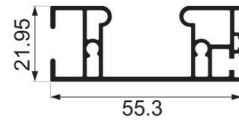

JY-50TS-04
upper frame
Weight : 0.695 kg/m

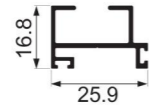

JY-50TS-05
door frame
Weight : 0.252 kg/m

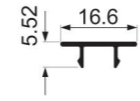

JY-50TS-06
outframe cover
Weight : 0.067 kg/m

► Assembly Diagram



► Accessories



upper folding window springs



flat handle



side hinge



handle hinge



aluminum latch rod



two-way lock box

45/50/60 Upper Folding Window >>>



Product Features :

- ① The window sash folds upwards, the accessories are hidden, and it does not take up the bottom space.
- ② Manually pull upwards, the folding sash can be hovered at any position and the height can be adjusted.
- ③ Suitable for installation at home and in shops and other application scenarios.

>>> EXTERIOR FOLDING SYSTEM

▶ 45/50/60 Upper Folding Window

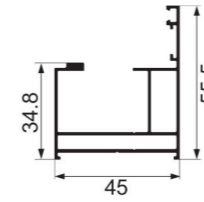

YC-SZ-4501
45 side frame
Weight : 0.705 kg/m

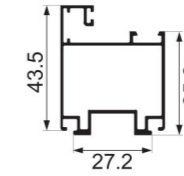

YC-SZ-4502
45 door frame
Weight : 0.596 kg/m

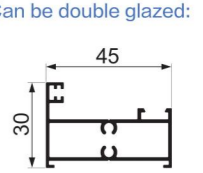

*Can be double glazed:
YC-SZ-4504
45 center column
Weight : 0.556 kg/m

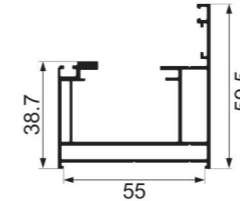

YC-SZ-5001
50 side frame
Weight : 1.011 kg/m

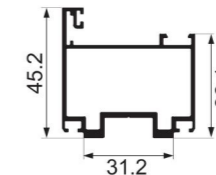

YC-SZ-5002
50 door frame
Weight : 0.843 kg/m

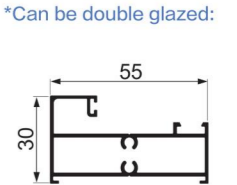

*Can be double glazed:
JNW-XT519
50 center column
Weight : 0.668 kg/m

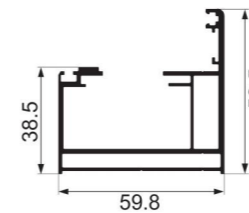

YC-SZ-6001
60 side frame
Weight : 1.251 kg/m

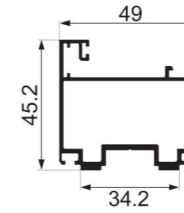

YC-SZ-6002
60 door frame
Weight : 0.873 kg/m

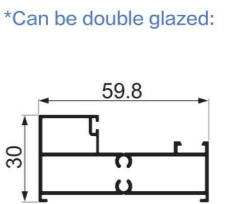

*Can be double glazed:
JNW-XT518
60 center column
Weight : 0.724 kg/m

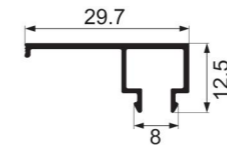

YC-SZ-5003
burclose 2
Weight : 0.152 kg/m

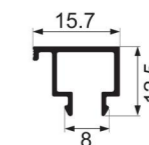

YC-SZ-4503
burclose 1
Weight : 0.114 kg/m

► Assembly Diagram

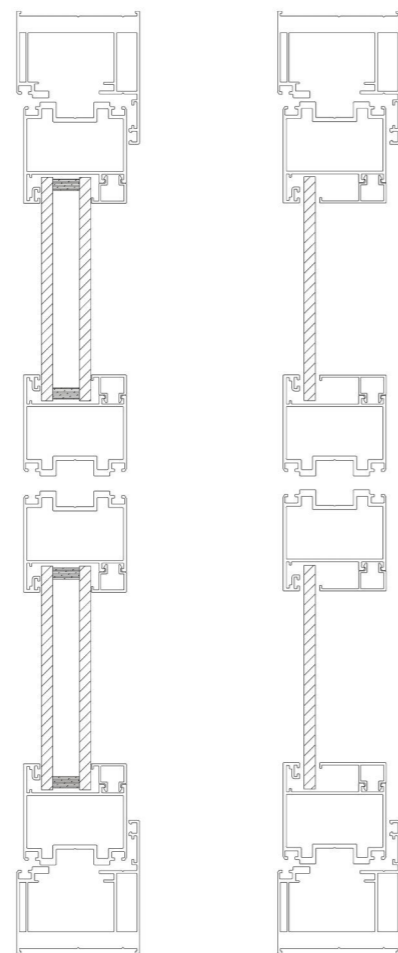

► Accessories



spring5N 6 position
spring7N 6 position



spring5N 5 position
spring7N 5 position



spring5N 4 position
spring7N 4 position



spring5N 3 position
spring7N 3 position



spring5N 2 position
spring7N 2 position



spring5N 1 position
spring7N 1 position



upper folding sword handle



upper folded tuning bar



upper folding two-way lock box (15)



upper folding slide lock



50/60 upper folding hinge



45 upper folding hinge



50/60 upper folding handle



45 upper folding handle



doorframe connector
21X33.8 one piece connector



water blocking strip for
vertical outer frame



upper folding spring seat



EP4501B EPDM rubber stripe



electric motor accessories set



side frame rubber stripe
EP4546C EPDM rubber stripe

42 Free Folding Door / Window >>>

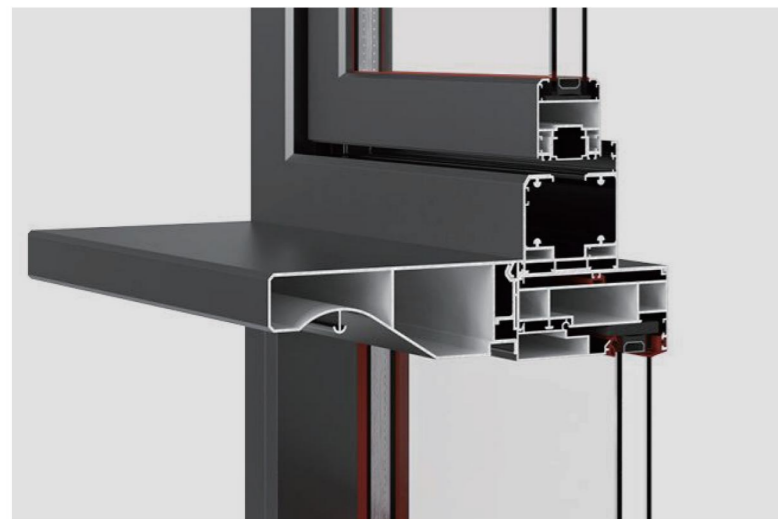

Product Features :

- ① Large opening space
- ② Foldable on both sides, unfolding in any position
- ③ Large ventilation with a large field of view

▶ 42 Free Folding Door / Window

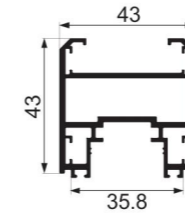

JY-42ZD-18
door frame
Weight : 0.897 kg/m

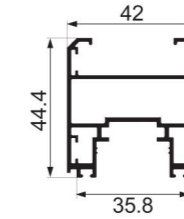

JY-42ZD-01
door frame
Weight : 0.897 kg/m

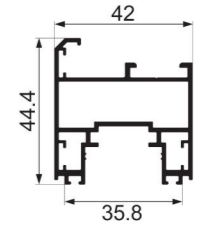

JY-42ZD-01
door frame
Weight : 0.882 kg/m

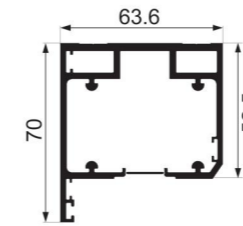

JY-42ZD-19
upper track/outframe
Weight : 1.70 kg/m

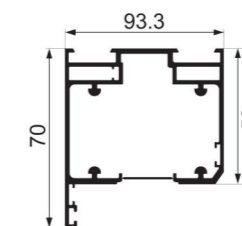

JY-42ZD-02
upper track/outframe
Weight : 1.661 kg/m

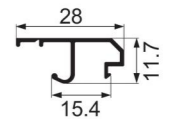

WB-42ZD-01
clip
Weight : 0.173 kg/m

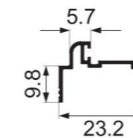

JY-42ZD-06
closing
Weight : 0.15 kg/m

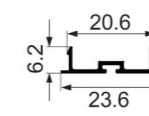

JY-42ZD-03
side frame cover
Weight : 0.091 kg/m

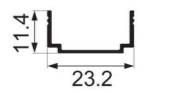

JY-42ZD-04
vertical door frame auxiliary part
Weight : 0.115 kg/m

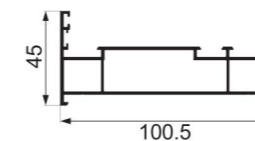

JY-42ZD-15
side frame
Weight : 1.377 kg/m

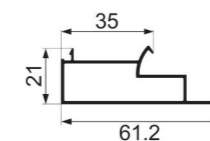

JY-42ZD-16
clip
Weight : 0.469 kg/m

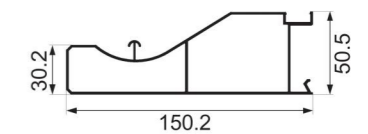

JY-42ZD-12
handrail
Weight : 1.98 kg/m

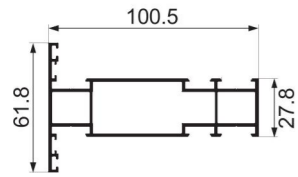

JY-42ZD-14
center column
Weight : 1.57 kg/m

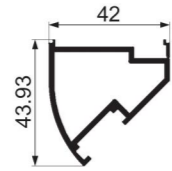

JY-42ZD-10
corners
Weight : 0.743 kg/m



JY-42ZD-13
handrail auxiliary part
Weight : 0.284 kg/m

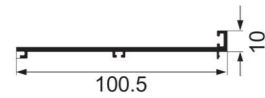

JY-42ZD-17
outframe auxiliary part
Weight : 0.675 kg/m

► **Assembly Diagram**

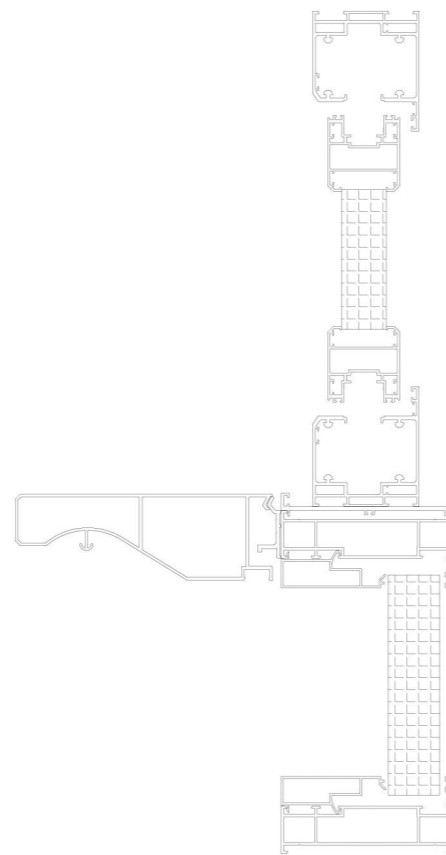
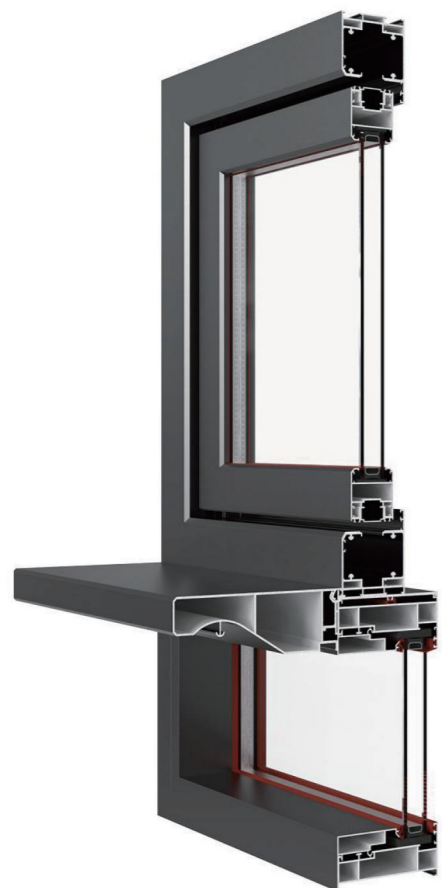

► **Accessories**



14.6*17.5 bracket for fixed outer frame (match JY-42ZD-15)



17.6*14.5 bracket for fixed middle outer frame (match JY-42ZD-14)



4.9*16.4 bracket for outer frame (match JY-42ZD-20)



11.7*39 bracket for sash panel frame (match JY-42ZD-01)



8*1.4 corner for sash panel frame (match JY-42ZD-01)



top wheel



bottom wheel



42 folding window handrail cover + hook



rubber for sash panel frame (match JY-42ZD-01)



rubber for vertical interlock frame (match JY-42ZD-06)

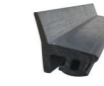

rubber for fixed outer frame (match JY-42ZD-15)



rubber for outer frame (match JY-42ZD-20)



base part for the wheel



normal hinge for sash panel



handle



lock



transmission box for lock



latch lock



punching mold

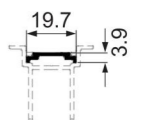

transmission rod for lock

50 Anti-Pinch Folding Door / Window >>>

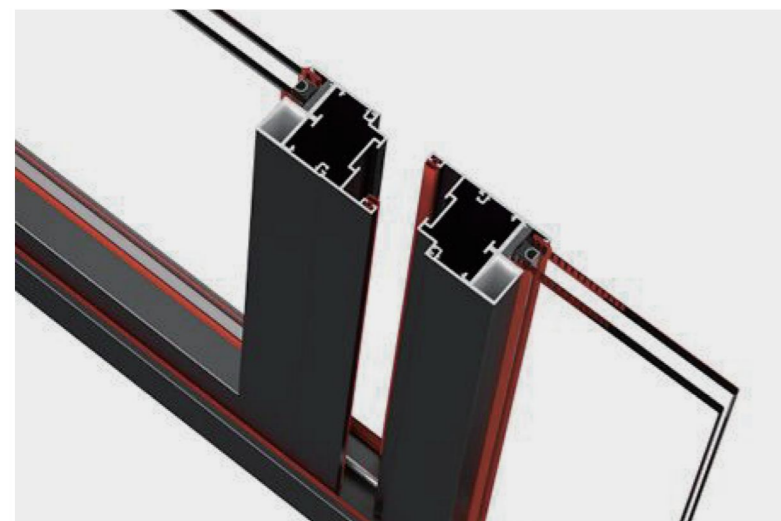

Product Features :

- ① After the door is closed, the hinge and pulley block are completely hidden.
- ② It can be used as a 90-degree corner without a column.
- ③ Profiles and hardware are common to doors and windows.

▶ 50 Anti-Pinch Folding Door / Window

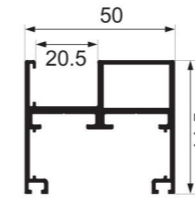

JY-50ZD-07
door frame
Weight : 1.1 kg/m

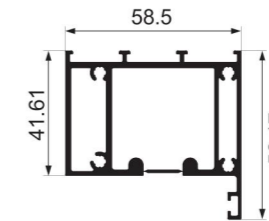

JY-50ZD-05
hanging rail
Weight : 1.6 kg/m

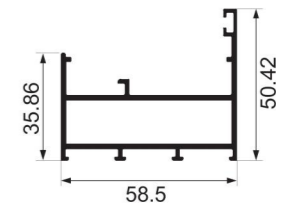

JY-50ZD-01
side frame
Weight : 1.06 kg/m

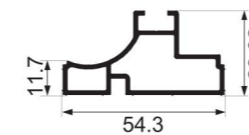

JY-50ZD-02
small outframe
Weight : 0.703 kg/m



JY-50ZD-19
bottom rail
Weight : 0.666 kg/m



JY-50ZD-06
bottom rail
Weight : 0.592 kg/m

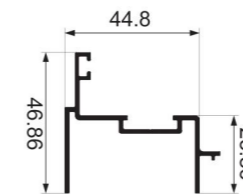

JY-50ZD-04
outframe closing
Weight : 0.588 kg/m

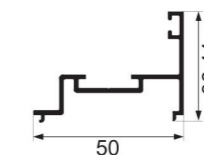

JY-50ZD-08
door frame closing
Weight : 0.497 kg/m

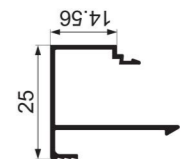

JY-50ZD-10A
window pressing line 1
Weight : 0.218 kg/m

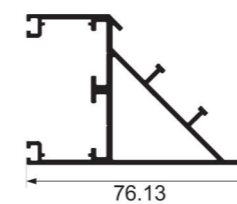

JY-50ZD-09
corner
Weight : 1.23 kg/m

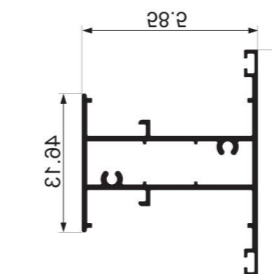

JY-50ZD-11
window center column
Weight : 1.35 kg/m

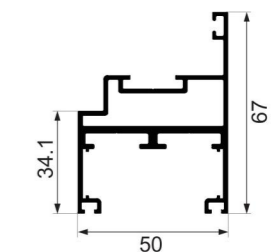

JY-50ZD-12
mullion
Weight : 1.3 kg/m

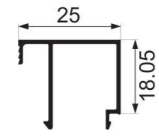

JY-50ZD-13A
window pressing line 2
Weight : 0.204 kg/m

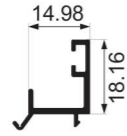

JY-50ZD-14
window pressing line 3
Weight : 0.193 kg/m

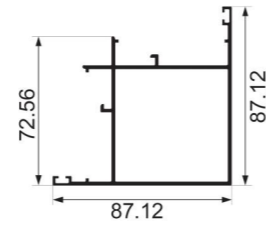

JY-50ZD-15
fixed corner
Weight : 1.65 kg/m

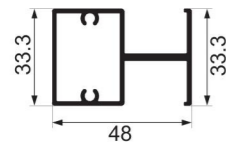

JY-50ZD-16
door frame center column
Weight : 0.82 kg/m

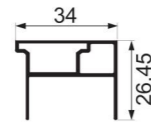

JY-50ZD-17
swing vertical door frame auxiliary part
Weight : 0.411 kg/m

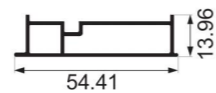

JY-50ZD-18
swing outframe auxiliary part
Weight : 0.459 kg/m

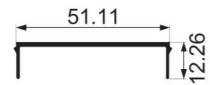

JY-50ZD-03
outframe cover
Weight : 0.287 kg/m

► Assembly Diagram

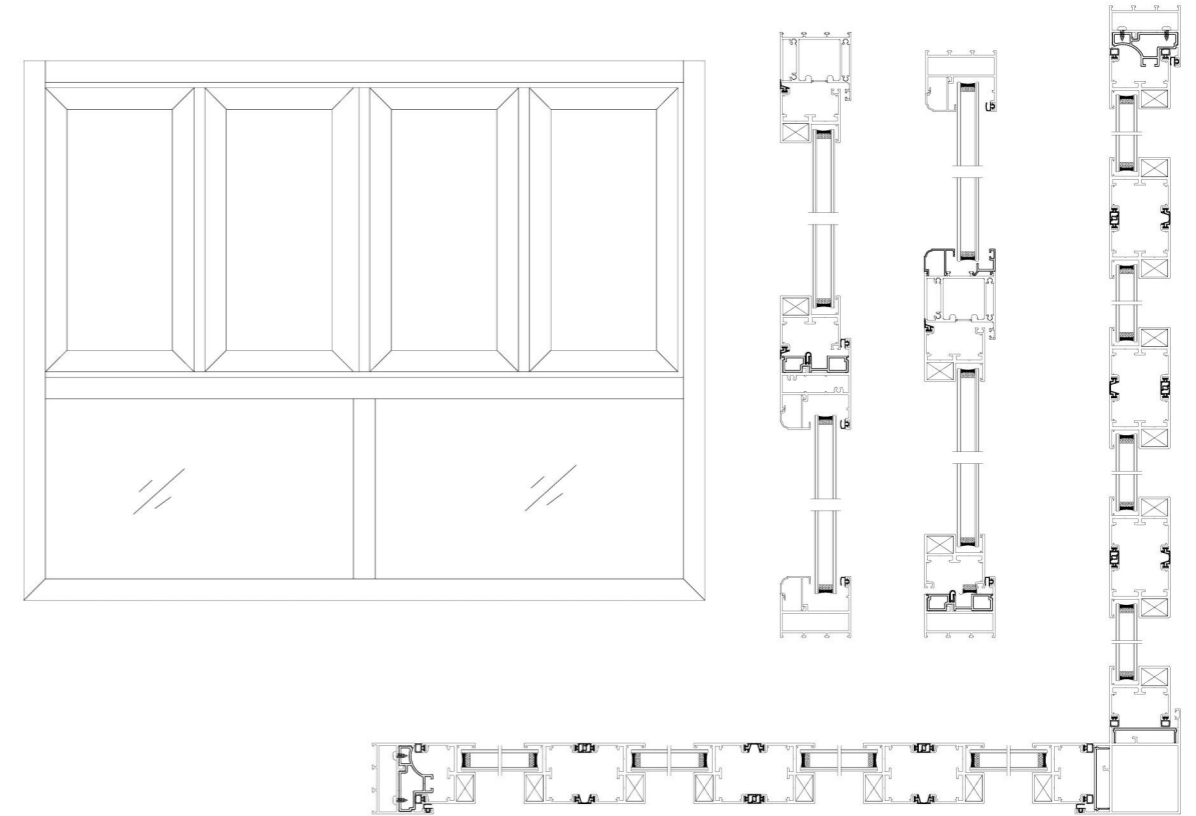

① 110 assembly drawing:

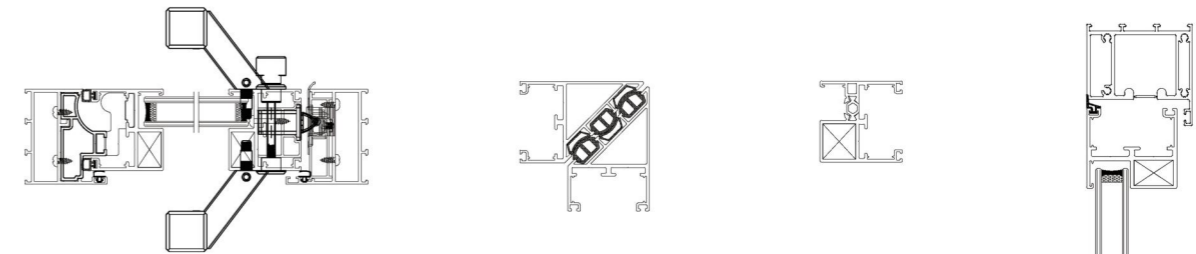

② 321 folding door assembly drawing:

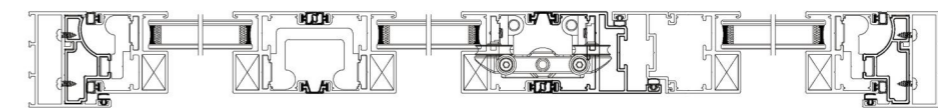

③ 330 folding door assembly drawing:

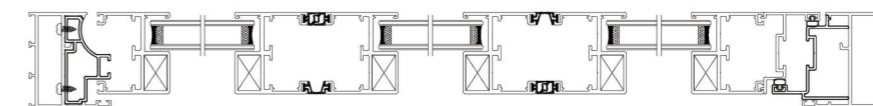

④ 422 folding door assembly drawing:

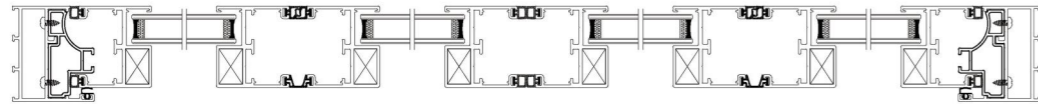

⑤ 421 folding door assembly drawing:

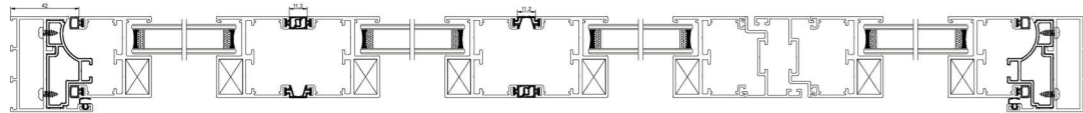

⑥ 440 folding door assembly drawing:

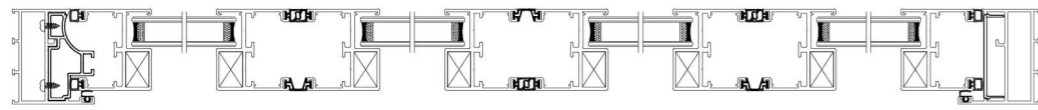

▶ Accessories



hinge for vertical outframe and door panel

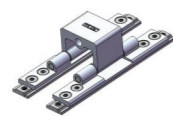

hidden hinge for between door panel

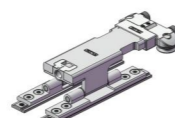

bottom wheel set between door panel (3+1)

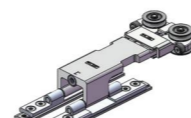

top wheel set between door panel (3+1)



bottom wheel set for end door panel (2+2) left

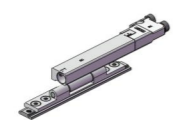

bottom wheel set for end door panel (2+2) right

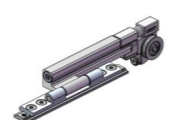

top wheel set for end door panel (2+2) left



bottom wheel set for end door panel (2+2) right



handle left



top and bottom latch lock right

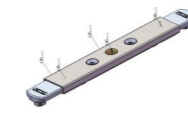

actuator for latch lock left



connector for actuator (for opening outside)



swing door lock handle



stainless steel rail for bottom track



corner for door panel (glass gap)



corner for door panel



corner for outframe



rubber for sash panel frame (match JY-42ZD-01)

58Pro Fully Sealed Folding Door >>>

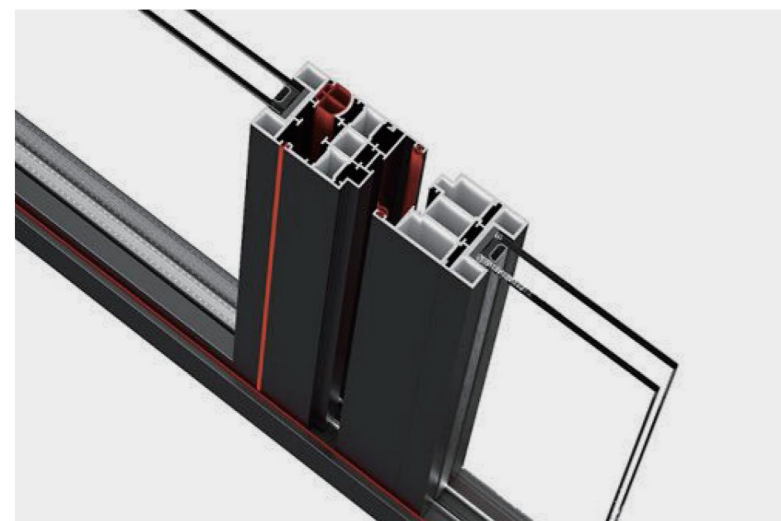

Product Features :

- ① Anti-pinch design
- ② Enhanced noise reduction, multiple opening options
- ③ Can be designed as one-piece or thermal break

> 58Pro Fully Sealed Folding Door (non-thermal break)

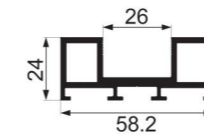

JY-58PRO-04

door frame
Weight : 1.129 kg/m

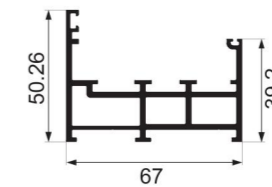

JY-58PRO-01

side frame
Weight : 1.623 kg/m

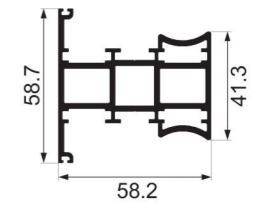

JY-58PRO-02

big center column
Weight : 1.862 kg/m

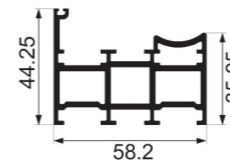

JY-58PRO-03

small center column
Weight : 1.594 kg/m

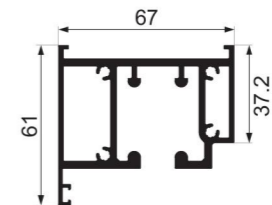

JY-58PRO-10

hanging rail
Weight : 2.300 kg/m

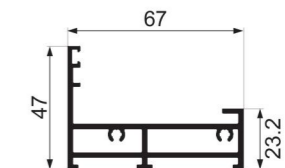

JY-58PRO-11

big lower rail
Weight : 1.318 kg/m

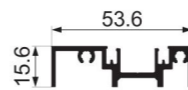

JY-58PRO-15

small lower rail
Weight : 0.726 kg/m

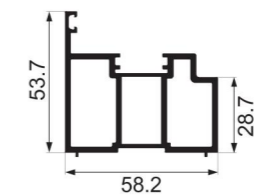

JY-58PRO-05

door frame closing
Weight : 1.571 kg/m

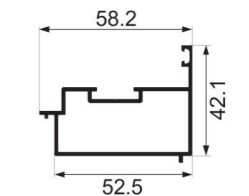

JY-58PRO-07

outframe closing
Weight : 0.745 kg/m

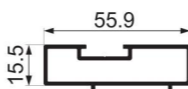

JY-58PRO-06

outframe auxiliary part
Weight : 0.609 kg/m

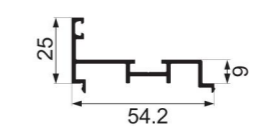

JY-58PRO-08

small center column closing
Weight : 0.485 kg/m

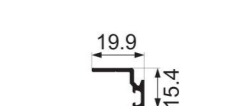

JY-58PRO-13

upper and lower frame auxiliary part
Weight : 0.157 kg/m

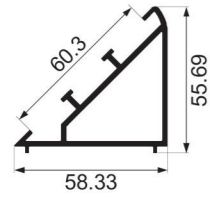

JY-58PRO-14

corner

Weight : 1.088 kg/m

► **Assembly Diagram**

① 220 folding door assembly drawing:

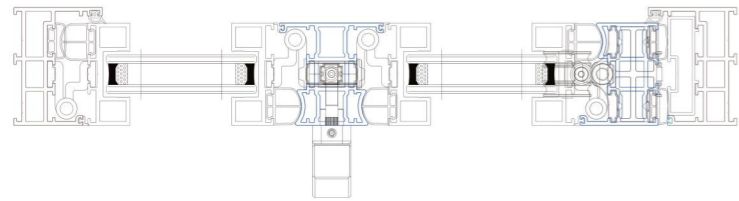

② 321 folding door assembly drawing:

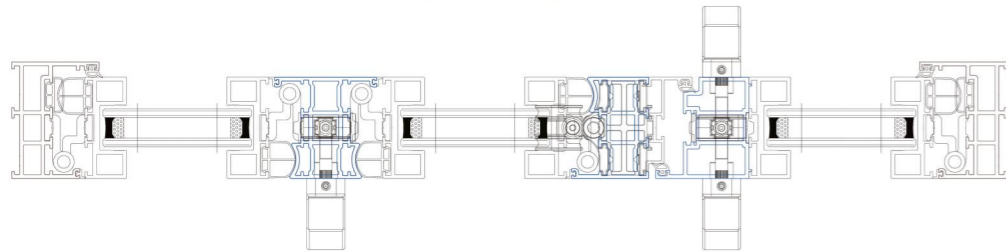

③ 330 folding door assembly drawing:

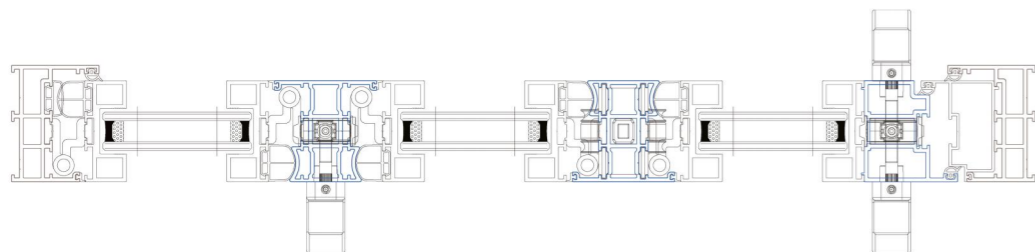

④ 431 folding door assembly drawing:

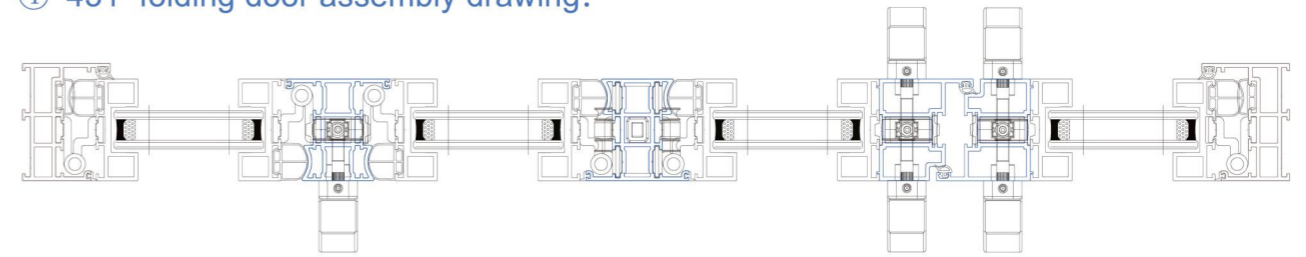

⑤ 422 folding door assembly drawing:

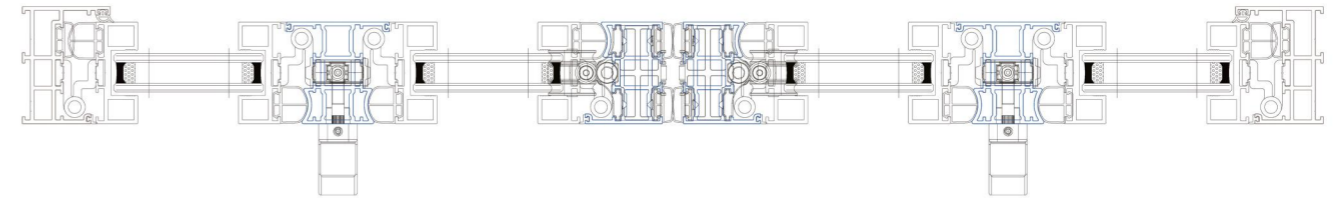

⑥ 440 folding door assembly drawing:

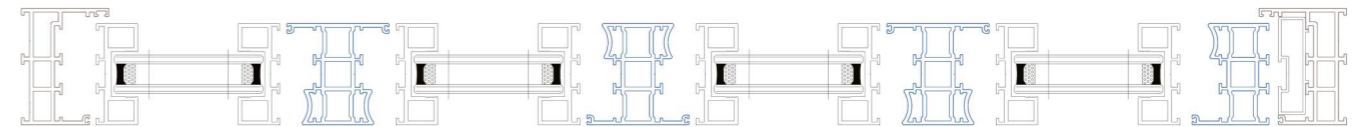

► 58Pro Fully Sealed Folding Door (thermal break)

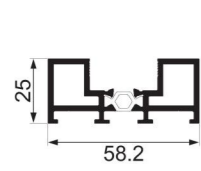

JY-58DQ-03
split splicing door frame
Weight : 0.566 kg/m

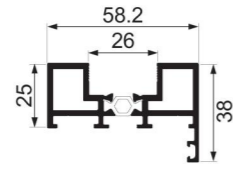

JY-58DQ-03 + JY-58DQ-27
integrated splicing door frame
Weight : 0.566 kg/m , 0.642 kg/m

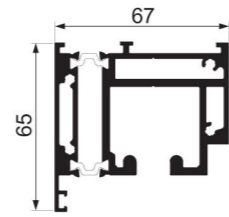

JY58DQ-11 + JY58DQ-12
hanging rail
Weight : 0.822 kg/m , 1.965 kg/m

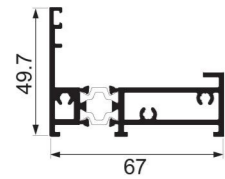

JY-58DQ-14 + JY58DQ-16
big lower rail
Weight : 0.590 kg/m , 0.835 kg/m

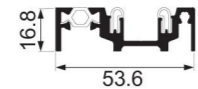

JY-58DQ-15 + JY58DQ-13
small lower rail
Weight : 0.144 kg/m , 0.622 kg/m

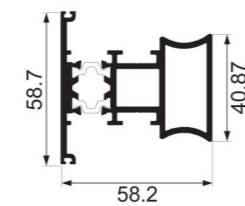

JY-58DQ-01 + JY58DQ-02
big center column
Weight : 0.584 kg/m , 1.183 kg/m

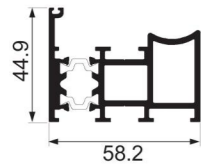

JY-58DQ-08 + JY-58DQ-07
small center column
Weight : 0.478 kg/m , 1.117 kg/m

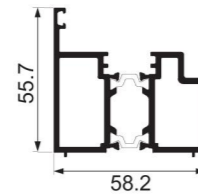

JY58DQ-23 + JY58DQ-24
door frame closing
Weight : 0.879 kg/m , 0.765 kg/m

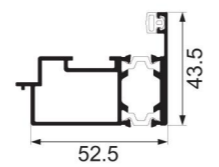

JY-58DQ-29 + JY-58DQ-28
outframe closing
Weight : 0.603 kg/m , 0.357 kg/m

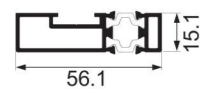

JY-58DQ-09 + JY-58DQ-06
outframe auxiliary part
Weight : 0.491 kg/m , 0.216 kg/m

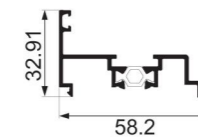

JY-58DQ-25 + JY-58DQ-26
small center column closing
Weight : 0.351 kg/m , 0.244 kg/m

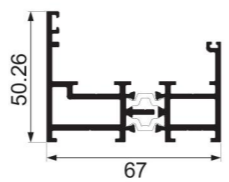

JY-58DQ-22 + JY-58DQ-21
side frame
Weight : 0.959 kg/m , 0.689 kg/m

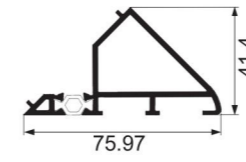

JY-58DQ-17 + JY-58DQ-18
corner
Weight : 0.198 kg/m , 0.910 kg/m

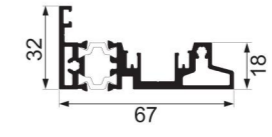

JY-58DQ-19 + JY-58DQ-20
low track
Weight : 0.398 kg/m , 0.826 kg/m

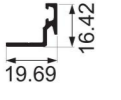

JY-58DQ-10
upper and lower frame auxiliary part
Weight : 0.166 kg/m

► Assembly Diagram

① 220 folding door assembly drawing:

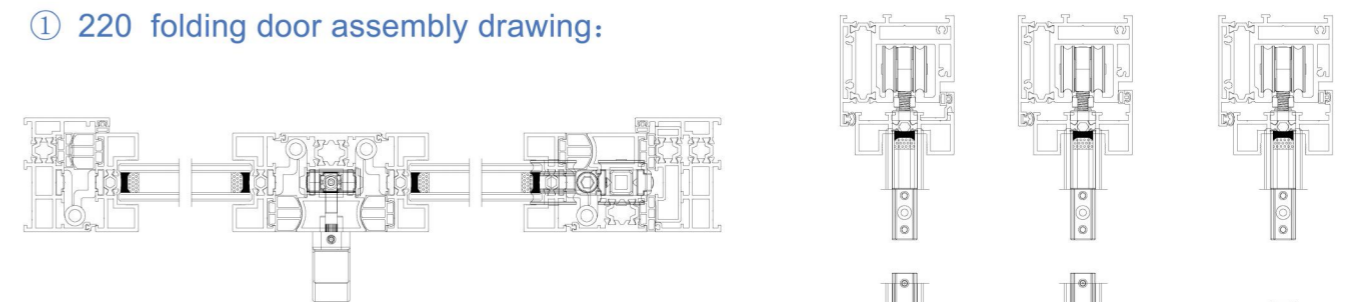

② 321 folding door assembly drawing:

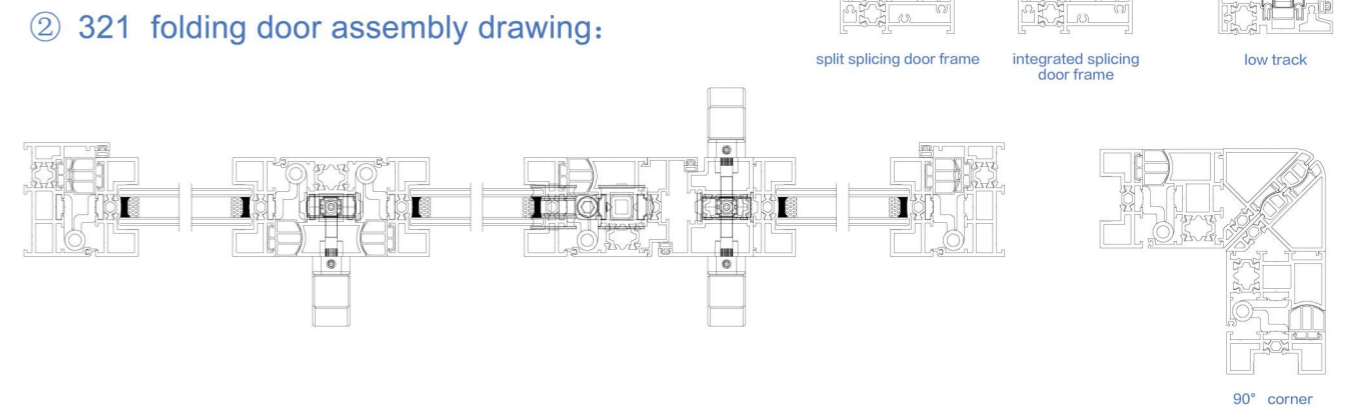

③ 330 folding door assembly drawing:

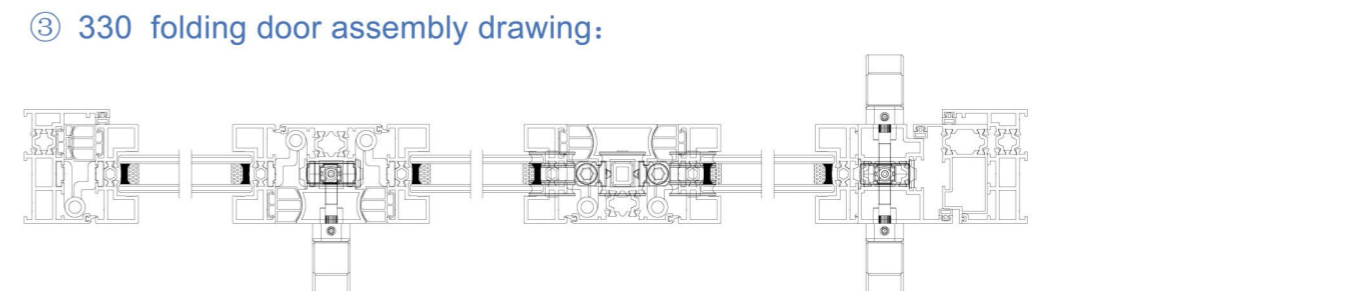

④ 431 folding door assembly drawing:

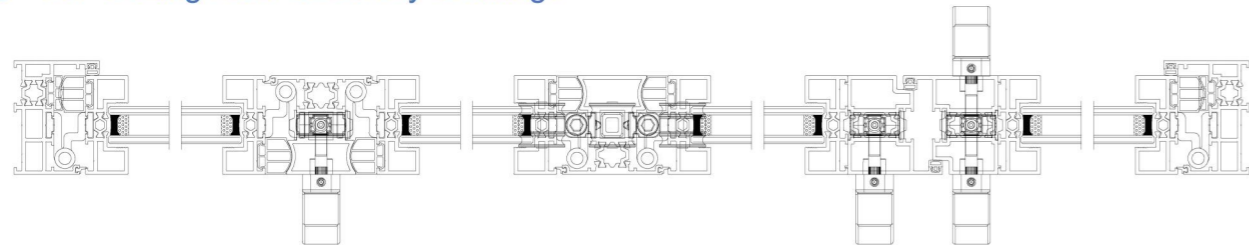

⑤ 422 folding door assembly drawing:

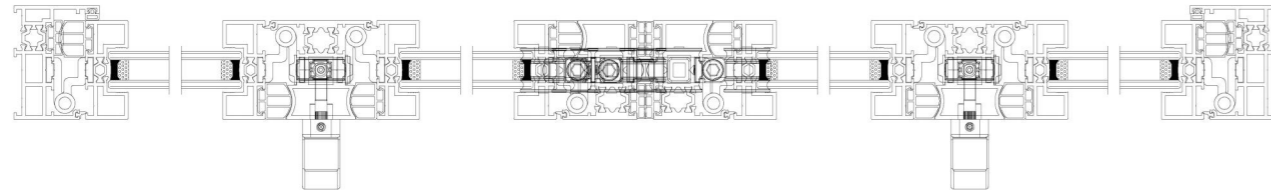

⑥ 440 folding door assembly drawing:

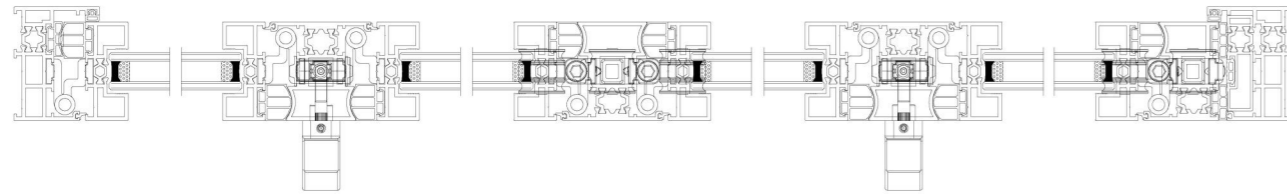

▶ Accessories

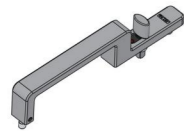

aluminum handle between two door

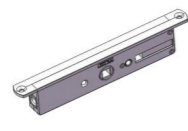

bidirectional actuator



top & bottom latch lock



hinge



top wheel for one door side



bottom wheel for one door side



top wheel between two door



bottom wheel between two door



lock body for swing door

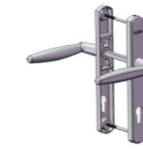

handle lock with key for swing door



lock cylinder



bracket for door panel frame



rubber for the door panel frame



rubber for vertical outframe



rubber for vertical seal profiles and top & bottom outframe



stainless steel bottom rail



punching machine

75KS Medium Narrow Folding Door >>>

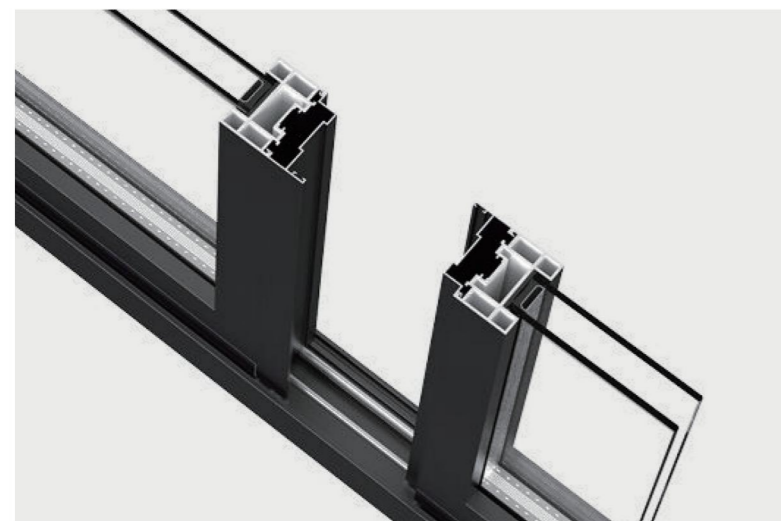

Product Features :

- ① The visible surface is only 42.5mm, and the door frame is even narrower
- ② Have thermal break option, which has better sound insulation and heat insulation effects

▶ 75KS Medium Narrow Folding Door (non-thermal break)

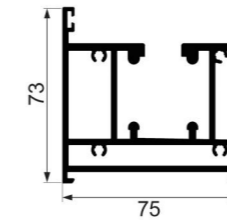

JY-75ZD-28
hanging rail
Weight : 3.210 kg/m

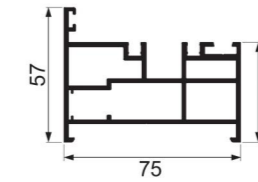

JY-75ZD-17
side frame
Weight : 1.918 kg/m



JY-75ZD-06
low track
Weight : 0.915 kg/m

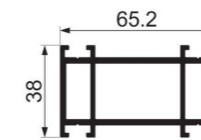

JY-75ZD-26
even-numbered central column
Weight : 1.740 kg/m

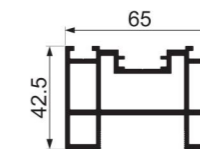

JY-75ZD-27
door frame
Weight : 1.890 kg/m

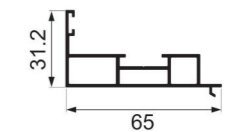

JY-75ZD-31
outframe closing
Weight : 0.736 kg/m

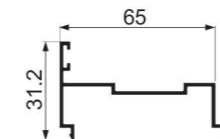

JY-75ZD-04
door frame closing
Weight : 0.441 kg/m

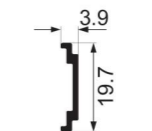

YC-CDG
flat aluminum transmission rod
Weight : 0.090 kg/m

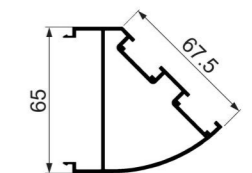

JY-75ZD-09
corner
Weight : 1.081 kg/m

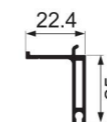

JY-75ZD-29
bottom frame accessories
Weight : 0.276 kg/m

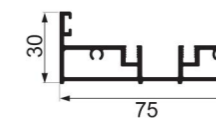

JY-75ZD-39
bottom rail
Weight : 1.110 kg/m

▶ **75KS Medium Narrow Folding Door (thermal break)**

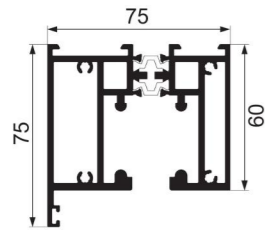

JY75ZD-24 + JY75ZD-25
hanging rail
Weight : 1.890 kg/m , 1.520 kg/m

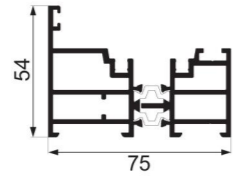

JY75ZD-18 + JY75ZD-19
side frame
Weight : 1.430 kg/m , 1.060 kg/m

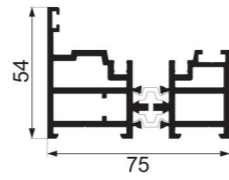

JY75ZD-38 + JY75ZD-37
side frame
Weight : 1.140 kg/m , 0.914 kg/m

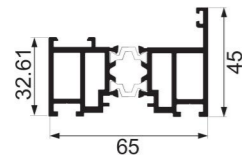

JY75ZD-21 + JY75ZD-20
door frame
Weight : 0.845 kg/m , 0.927 kg/m

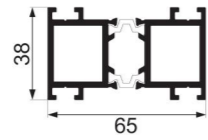

JY-75ZD-22
center column
Weight : 0.865 kg/m

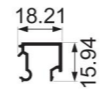

JY-75ZD-23A
door frame clip
Weight : 0.200 kg/m

▶ **Assembly Diagram**

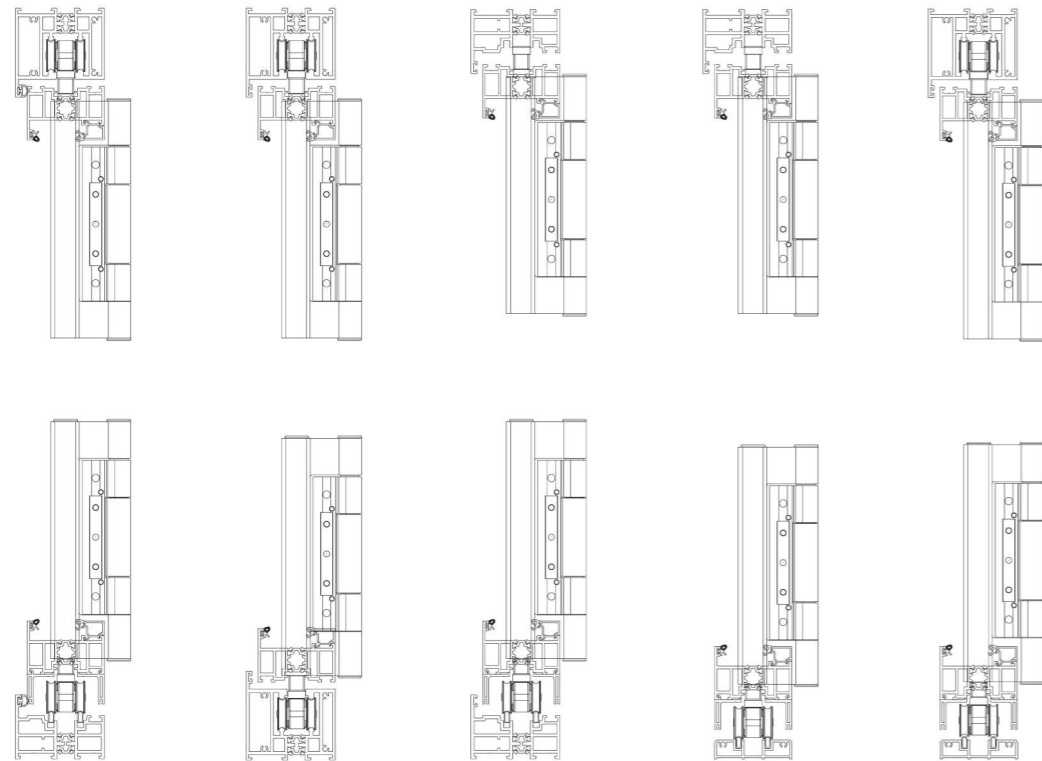

① 220 folding door assembly drawing:

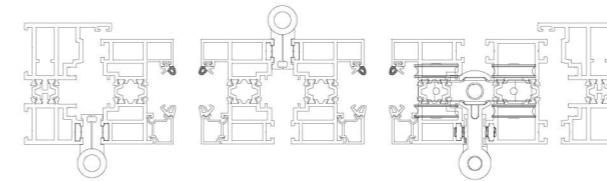

② 321 folding door assembly drawing:

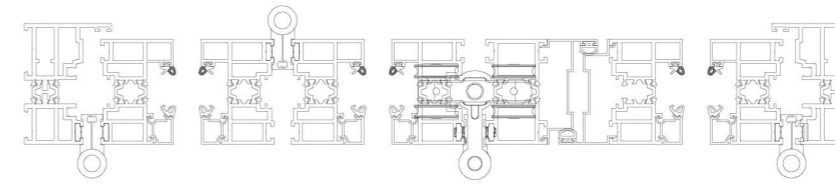

③ 330 folding door assembly drawing:

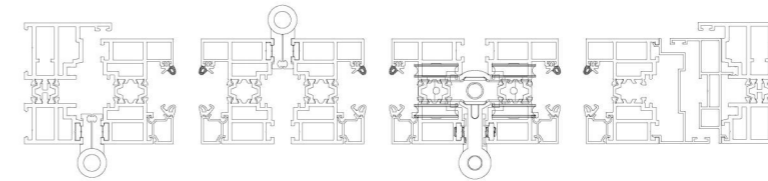

④ 431 folding door assembly drawing:

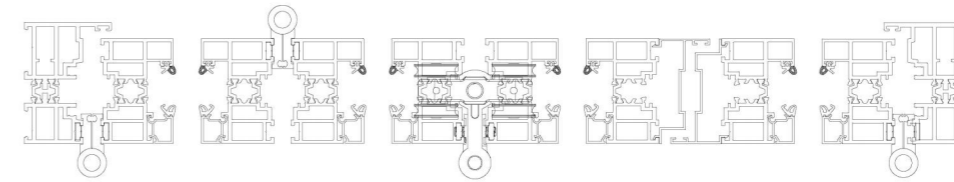

⑤ 422 folding door assembly drawing:

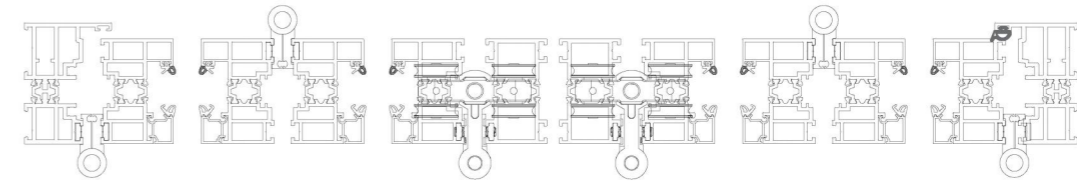

► Accessories



15 two-way drive (90 degrees)



30*92 swing door lock body



slave handle



bolt deadbolt



hinges A



hinges C



upper positioning wheel



bottom wheels



stainless steel



corner connector



rubber strip A



rubber strip B



rubber strip C



rubber strip D



rubber strip E



rubber strip F

75HOPO Folding Door >>>



Product Features :

- ① Can be higher than 4m
- ② With hopo accessories

► 75HOPO Folding Door

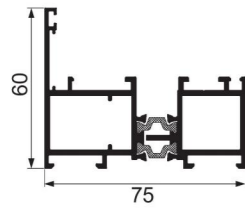

JY-HOPO-001 + JY-HOPO-002
upper rail
Weight : 0.974 kg/m , 0.766 kg/m

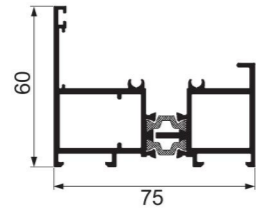

JY-HOPO-012 + JY-HOPO-013
lower rail
Weight : 0.935 kg/m , 0.767 kg/m

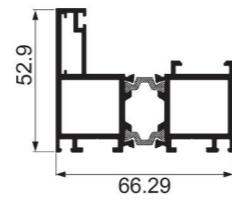

JY-HOPO-003 + JY-HOPO-004
door frame
Weight : 0.962 kg/m , 0.725 kg/m

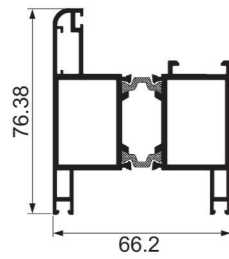

JY-HOPO-010 + JY-HOPO-009
upper and lower frame
Weight : 1.09 kg/m , 0.903 kg/m

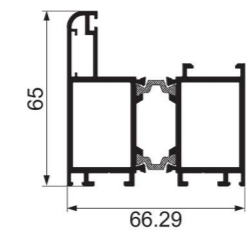

JY-HOPO-008 + JY-HOPO-007
door frame
Weight : 1.04 kg/m , 0.847 kg/m

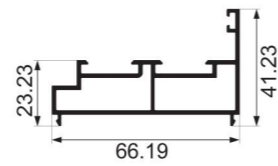

JY-HOPO-006
closing
Weight : 0.935 kg/m

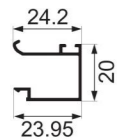

JY-HOPO-005
clip
Weight : 0.218 kg/m

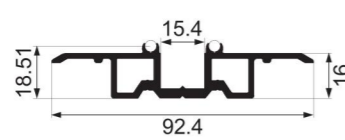

JY-HOPO-011
lower rail
Weight : 1.18 kg/m

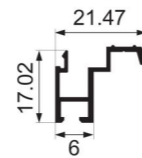

JY-HOPO-014
upper and lower frame auxiliary materials
Weight : 0.191 kg/m

► Assembly Diagram

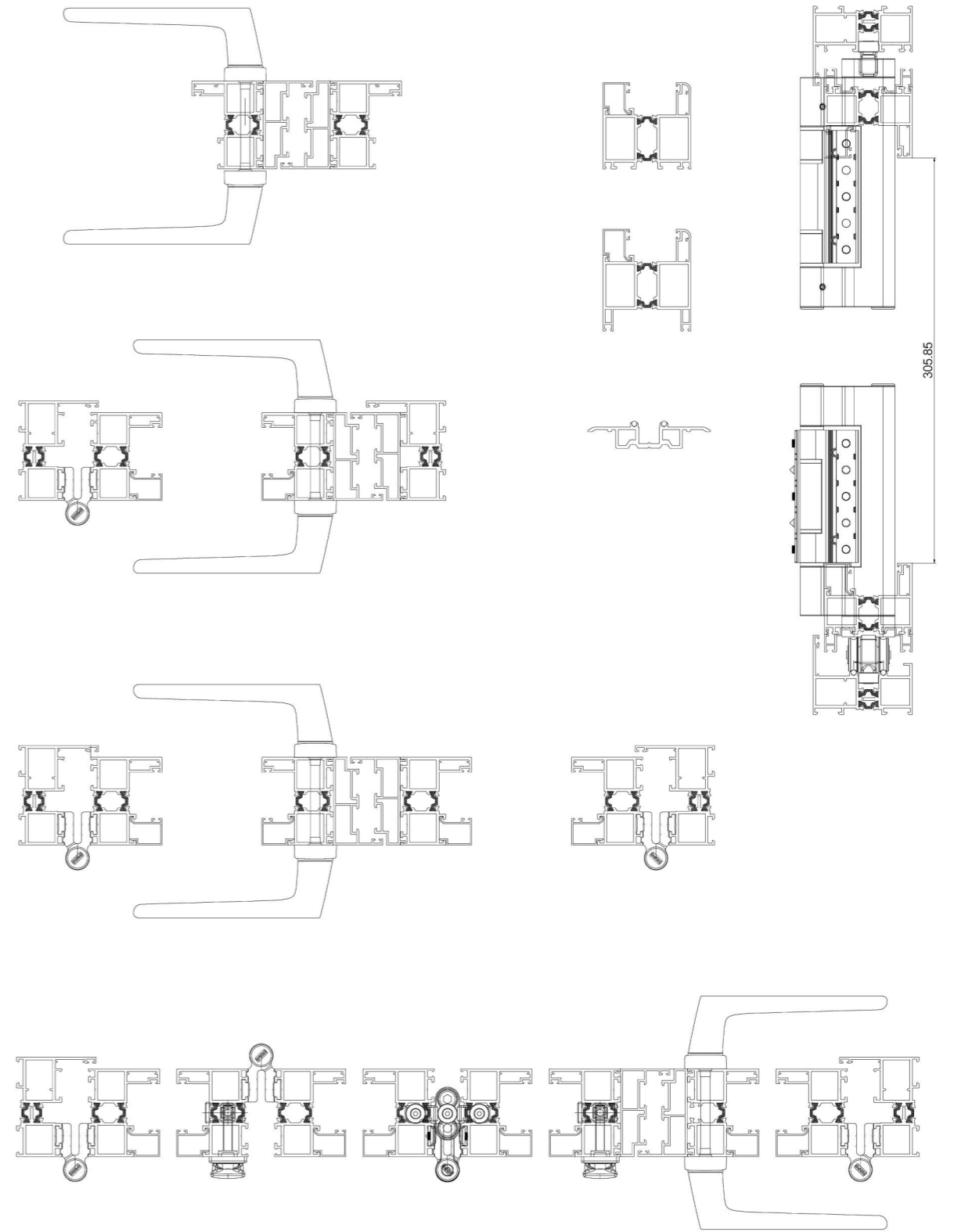

► Accessories



hinge components ASH65.03



pulldriver AHH65



gear case AGC65.14



leafcatcher TBL65.01X



roller components ABR65.40



mortislock SDL51.32



PH171 handle



double-side door handle sets HSD633



locking plate ALPD50.07



c99 cylinder



shoot bolt ASB60.00/ASB65.10

75 Large Folding Door >>>

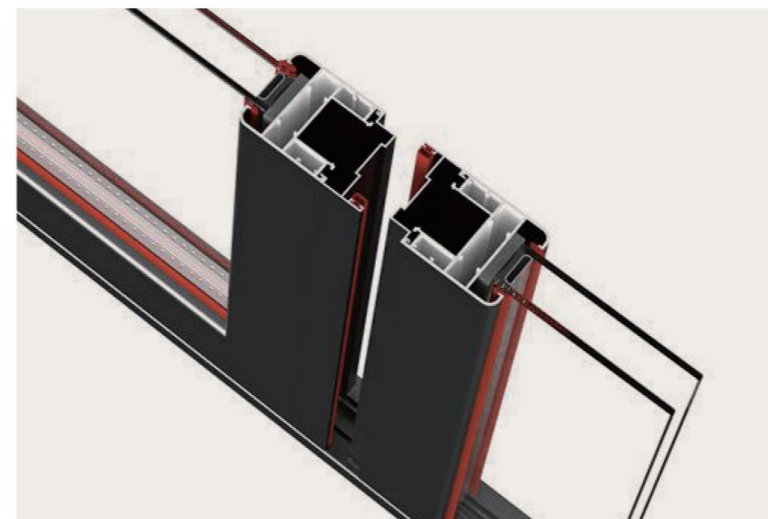

Product Features :

- ① Can be up to 5m high
- ② Hot sale in middle east market

▶ 75 Large Folding Door (non-thermal break)

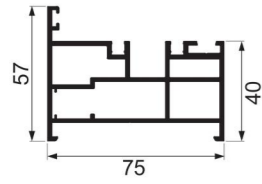

JY-75ZD-02
side frame
Weight : 1.971 kg/m

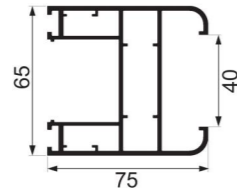

JY-75ZD-01
door frame
Weight : 1.935 kg/m

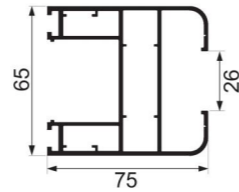

JY-75ZD-07
door frame
Weight : 1.923 kg/m



JY-75ZD-06
bottom rail
Weight : 0.915 kg/m

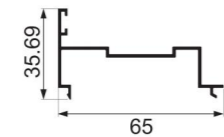

JY-75ZD-04
closing 1
Weight : 0.441 kg/m

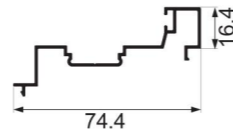

JY-75ZD-05
closing 2
Weight : 0.506 kg/m

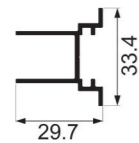

JY-75ZD-03
excipients
Weight : 0.370 kg/m

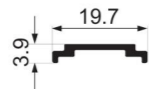

YC-CDG
flat aluminum transmission rod
Weight : 0.090 kg/m

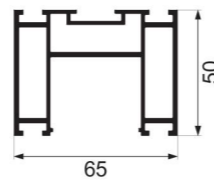

JY-75ZD-08
closing door frame
Weight : 1.679 kg/m

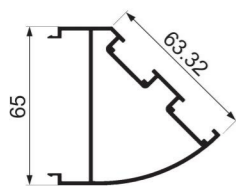

JY-75ZD-09
corner
Weight : 1.081 kg/m

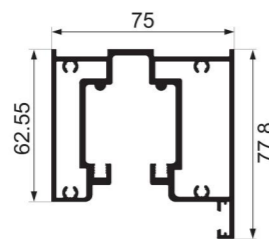

JY-75ZD-10
hanging rail
Weight : 2.804 kg/m

▶ 75 Large Folding Door (thermal break)

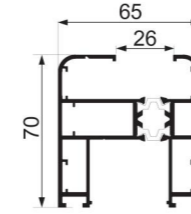

JY-75DQ-01 + JY-75DQ-02
sash frame
Weight : 1.201 kg/m , 0.918 kg/m

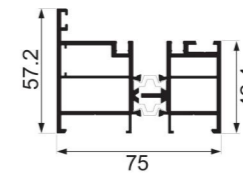

JY-75DQ-03 + JY-75DQ-04
out frame
Weight : 1.117 kg/m , 0.958 kg/m

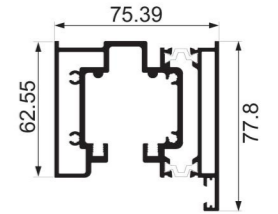

JY-75DQ-05 + JY-75DQ-06
hanging rail
Weight : 2.224 kg/m , 0.900 kg/m

▶ Assembly Diagram

① 220 folding door assembly drawing:

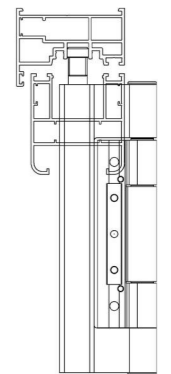
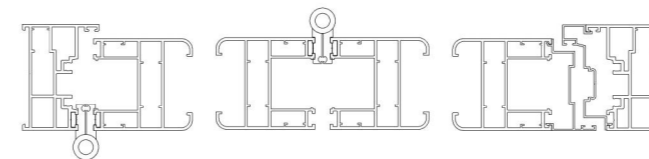

② 321 folding door assembly drawing:

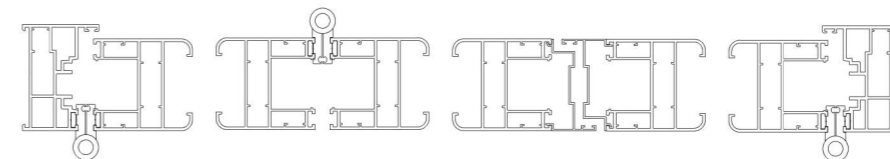

③ 330 folding door assembly drawing:

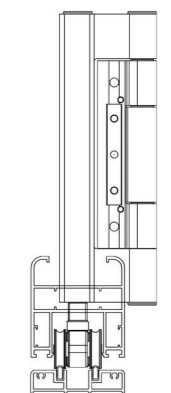
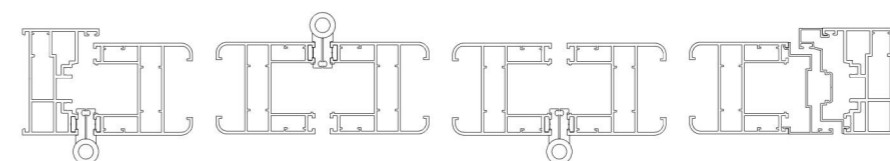

④ 422 folding door assembly drawing:

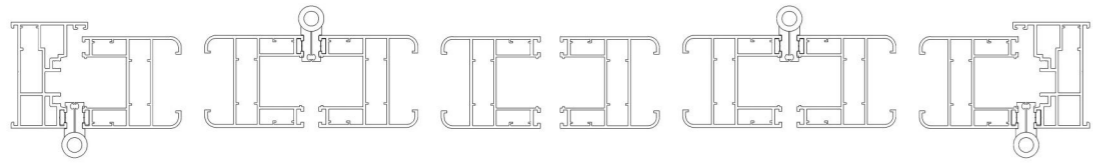

⑤ 431 folding door assembly drawing:

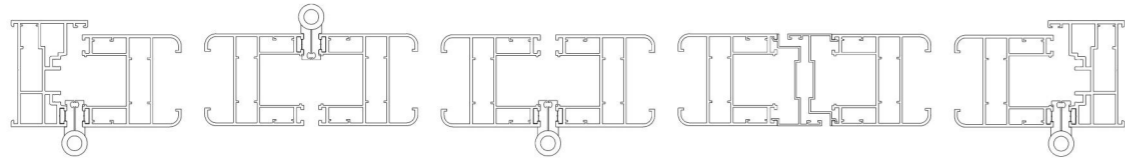

▶ Accessories



29.5*15 bracket for outer fram connection



C4.8*11.5 stainless steel rail for bottom track



top roller for single door



lower wheel single hinge steel casting



hinge with handle



top roller for double door



lower wheel double hinge steel casting



anti-collision rubber for door vertical frame



swing door lock



lock cylinder



sword shape handle



punching machine

120 Anti-Pinch Folding Door / Window >>>

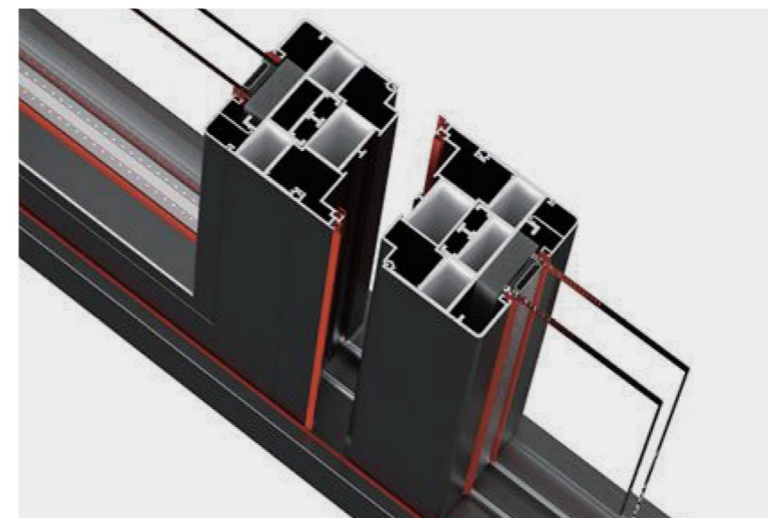

Product Features :

- ① Hidden hinges are simpler
- ② The height can reach seven meters
- ③ Anti-pinch rubber strips ,sealing strips are more soundproof
- ④ The lower pulley with ball bearing to prevent wind and rainwater from seeping into the room

▶ 120 Anti-Pinch Folding Door / Window

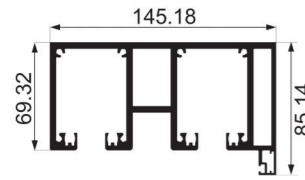

JY-120-01
hanging rail
Weight : 6.582 kg/m

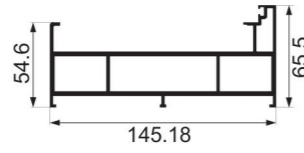

JY-120-02
side frame
Weight : 3.715 kg/m

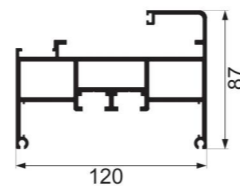

JY-120-05
door frame
Weight : 4.303 kg/m

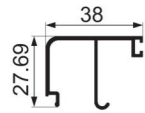

JY-120-06
door frame clip
Weight : 0.404 kg/m



JY-120-03
bottom rail
Weight : 1.841 kg/m



JY-120-04
small outframe
Weight : 2.514 kg/m

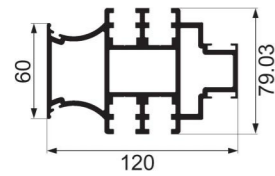

JY-120-07
big center column
Weight : 5.163 kg/m

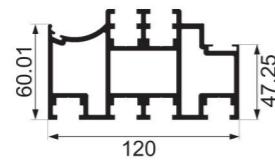

JY-120-08
small center column
Weight : 5.143 kg/m



JY-120-14
hinge screw spacer
Weight : 0.127 kg/m

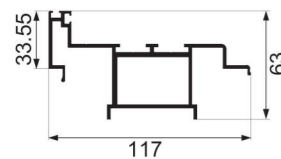

JY-120-09
door frame closing
Weight : 2.017 kg/m



JY-120-10
outframe closing
Weight : 1.652 kg/m



JY-120-11
small center column closing
Weight : 1.347 kg/m

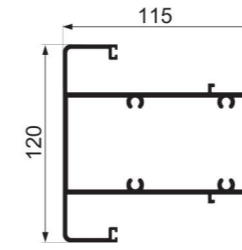

JY-120-13
door frame center cross
Weight : 4.244 kg/m

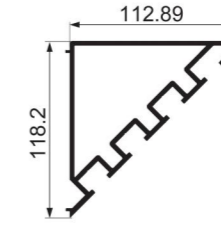

JY-120-12
corner
Weight : 3.951 kg/m

▶ Assembly Diagram

① 321 folding door assembly drawing:

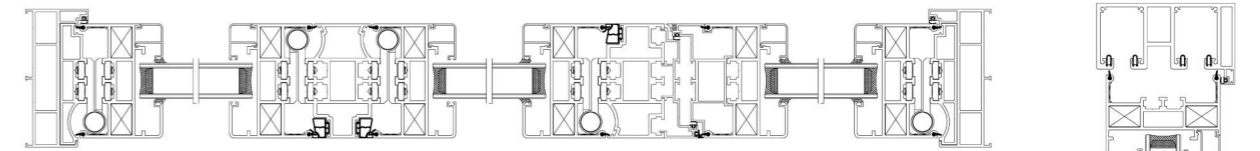

② 330 folding door assembly drawing:

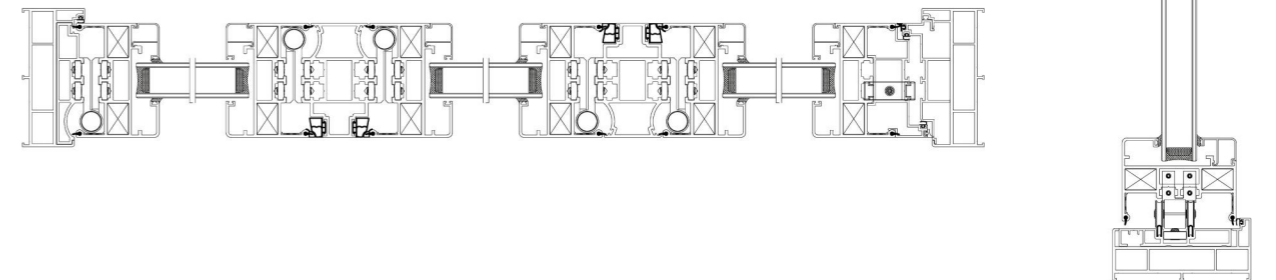

③ 431 folding door assembly drawing:

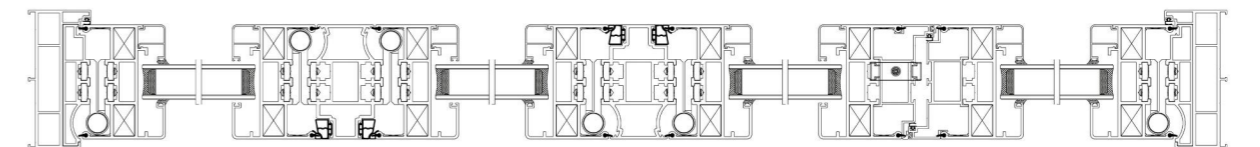

④ 440 folding door assembly drawing:

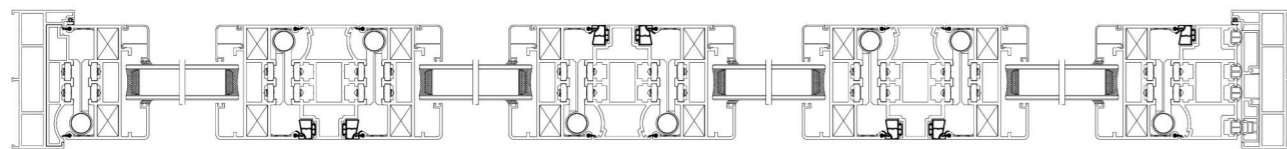

⑤ 422 folding door assembly drawing:

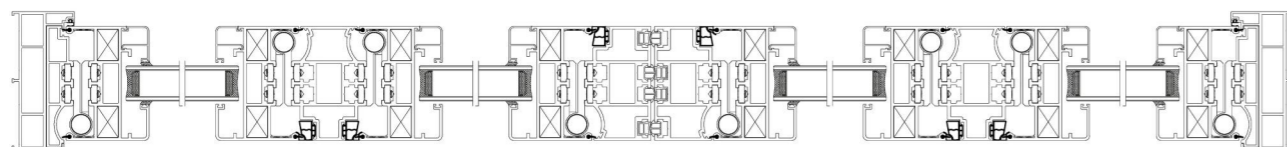

► Accessories



single-sided hinge



double-sided hinge



hinge



upper wheel with positioning



lower wheel (single-sided)



lower wheel (double-sided)



latch



swing door lock body



latch lock body



lock cylinder



handle lock



handle